

ADDENDUM NO. 1



Date: March 6, 2017

Bid Date: April 5, 2017
3:00 P.M. (Local Time)

Bid Name: Bus Stop Amenities

Bid No.: RTSX-180002-DS

NOTE: This Addendum has been issued to the holders of record of the specifications.

The original Specifications remain in full force and effect except as revised by the following changes which shall take precedence over anything to the contrary:

Question submittal deadline is March 23, 2017.

1. Initial questions received/City's response:

Question1: Closing date on the first two pages says April 5th 2017 – page 34 (Bid Form) says that the due date is March 29th. Can you please confirm which it is and possibly issue a new Bidform with any addendum?

Answer1: The bid due date is April 5, 2017. A revised Bid Form page 34 is included for your convenience.

Question2: Bonding is referenced on page 5 to refer to Special provisions section. When we look under special provisions there is no mention of bonding. Can we assume that as there is no fixed or minimum contract value there is no bonding required?

Answer2: That is correct, there is no bonding requirement.

Question3: The bid states that the shelter shall be powder coated but no color has been stated. Is there a preferred color?

Answer3: RAL 7043 Traffic Grey.

Question4: A domed or barrel vaulted roof is specified. Is there a preferred colour or material requested for the roof? Solid polycarbonate or fluted?

Answer4: RAL 7043 Traffic Grey. Aluminum metal roof.

Question5: When bidding the bus stop pole with lighting and lighted timetables are these to be solar or hard wired?

Answer5: Solar.

ACKNOWLEDGMENT: Each Proposer shall acknowledge receipt of this Addendum No. 1 by his or her signature below, and shall attach a copy of this Addendum to its proposal.

CERTIFICATION BY PROPOSER

The undersigned acknowledges receipt of this Addendum No. 1 and the Proposal submitted is in accordance with information, instructions, and stipulations set forth herein.

PROPOSER: PRIDE Enterprises
BY: 
DATE: March 31, 2017

ADDENDUM NO. 2



Date: March 28, 2017

Bid Date: April 5, 2017
3:00 P.M. (Local Time)

Bid Name: Bus Stop Amenities

Bid No.: RTSX-180002-DS

NOTE: This Addendum has been issued to the holders of record of the specifications.

The original Specifications remain in full force and effect except as revised by the following changes which shall take precedence over anything to the contrary:

Question submittal deadline has passed; no additional questions will be answered.

1. Initial questions received/City's response:

Question1: Does the City of Gainesville require stamped and sealed drawings to be included in bid proposal or after awarded contract?

Answer1: Before or after is fine.

Question2: Are there any bond requirements? If so, please specify.

Answer2: There are no bond requirements for this bid.

Question3: Are there any DBE requirements? If so, please specify.

Answer3: Our DBE goal is 1.5%. If bidder is using subcontractors, then they are highly encouraged to do so with a DBE to help the City reach its goal.

Question4: Under 2.6 of Section IV, it says, "RTS requires 5 full size drawings of each shelter type and amenity with 3 digitally signed CDs." Please clarify what is meant by "full size drawings."

Answer4: CDs with the "to scale" drawings should be sufficient.

Question5: Is there a preferred column size for each shelter type?

Answer5: No, but this may be determined by shelter calculations.

Question6: Shall columns be round or square for shelter types?

Answer6: It does not matter but round is the preferred option.

- Question7: Are there any drawings and/or photos of the bus shelters specified?
Answer7: Several photos of shelters have been included on pages 5-8 of this document.
- Question8: Does the City of Gainesville want Herringbone grillwork with these shelters as with previous shelters? Or, shall the wall sections be fully perforated metal?
Answer8: Either way is fine but we prefer to be consistent with previous shelters.
- Question9: Is there a preferred roof material for both the Dome and Barrel roof options?
Answer9: Metal preferred but same material as previous shelter is acceptable.
- Question10: Under 3.1.4.2 Roof, it specifies "welded J-hook on top corners of shelter, please clarify where the J-hook shall be located in regards to the roof."
Answer10: Hooks to be able to lift shelter in case of emergencies, any location that you considered appropriate to do so in that area.
- Question11: Is there a preferred bench material?
Answer11: Metal.
- Question12: Shall seat dividers be included in bench?
Answer12: Yes.
- Question13: Will the anti-vagrant bars be accepted if bolted into the concrete and not the bench seat?
Answer13: Yes.
- Question14: Under 3.3 Trash Receptacles, is a dome or lid preferred for the 20 gallon column mount option?
Answer14: Dome.
- Question15: Will the 3.4 Bicycle Racks specified be accepted in powder coated Aluminum?
Answer15: Yes.
- Question16: In regards to 3.5 Solar Lighting, does the City of Gainesville prefer a rigid or flex solar panel?
Answer16: No preference.
- Question17: What is the preferred runtime for the solar lighting in the shelter?
Answer17: No preferred runtime.
- Question18: Industry standard is minimum 2 foot candles at ground level and a 1.25 ALR on the solar calculator, is this your preferred output?
Answer18: Yes.
- Question19: In regards to 3.5 Solar Lighting "Other Lighting Features" what size schedule holder is preferred for the bus stop poles?
Answer19: 8.5" x 14".
- Question20: To clarify, you want a push-button activation for the bus shelter and the bus stop pole?
Answer20: Yes.

Question21: In order to maximize the amount of advertising revenue that Gainesville Regional transit would receive from each individual style of amenity, would you be open to the possibility of having separate revenue amounts offered by potential vendors for each? For example: One amount for advertising revenue for shelters and separate advertising revenue amount for the benches etc?

Answer21: No.

Question22: Asking for separate numbers would be more lucrative for the city and also you know the exact revenue share breakdown for each piece of furniture. Please confirm if this would be possible?

Answer22: No.

Question23: Regarding Price Sheet: The Bid Price sheet line Items 8, 10, 12, and 14 are for benches. Items 10, 12, 14 are clearly for the shelters. *What is the bench specification for line item 8?*

Answer23: Line Item 8 is not applicable, please strike through or ignore it on the price sheet.

Question24: Regarding Price Sheet: Bus Stop Pole with schedule holder. *What size document(s) should the scheduled holder accommodate?*

Answer24: 8.5" x 14".

Question25: Regarding Section 3. Amenity Specifications: 3.2 and 3.3 – Specifications for the benches and trash do not comply with the Streetscape Design and Technical Standards for the City of Gainesville. *Please verify the IFB specifications for the benches and trash are accurate and must not meet the standards in the aforementioned reference documentation.*

Answer25: The CRA requirements for benches (DuMor #Bench 58, Color: Black) and trash receptacles (DuMor #84-32, 32 gallon, Color: Black) are not applicable. However, we do want benches and trash receptacles similar in appearance to the specified brand.

Question26: Regarding Section 3.5 Solar Lighting: In our experience, the most reliable system for controlling the lighting inside a shelter is the use of a real time clock. This real-clock system allows for lighting to be turned off for a number of hour after bus service stops and on again just before bus service resumes in the morning. Please confirm if a real time light controller based on a day/date/time clock can be used to control the interior lighting in response to this RFP.

Answer26: No time clocks.

Question27: Industry standard lighting measurements use peak, average, and minimum light output foot candle readings in a given area of the shelter, for example: 5 fc at peak, 2.5 fc average and 0.1 fc in an area of 40 square feet measured at bench height. Please confirm that solar shelter lighting is required to meet these minimum light output specifications.

Answer27: Yes.

Question28: A self-test feature allows maintenance staff to check the systems operation, and state of health of shelter solar lighting 24/7. Please confirm if a self-test feature is required for the solar lighting system.

Answer28: Yes.

Question29: Regarding solar lighting safety, we recommend that solar lighting systems shall be UL (Underwriters Laboratory) certified, or certified by another Nationally Recognized Testing Laboratory (NRTL) Program certification. Products without a single system UL or other NRTL certification may have all major electrical components (defined as solar panel(s), batteries, LEDs and controller) with a NRTL listing. Please consider adding this requirement to the specification for your solar lighting system

Answer29: **This certification is not a requirement. The current contractor, Tolar Manufacturing Company, is providing "PV-Stop" by urbansolar. Bidders should be able to provide a similar product.**

Question30: To document that solar lighting systems meet minimum performance criteria, please confirm that submittals must include:

a. Detailed autonomy and battery reserve calculations in their proposal response to demonstrate the proposed system meet or exceed minimum autonomy/battery reserve of 5.

b. Calculations based on the worst available solar insolation data period for December in the last 20 years in Gainesville, FL.

c. Detailed ALR (Array to Load Ratio) calculations based on the worst solar isolation period of the year (December) for Gainesville and still adhering to the 1.25 Minimum ALR.

d. Photometric light plot drawings to provide confirmation of lighting level output specifications.

Answer30: **A product that meets the current contractor's "PV-Stop" solar lighting specifications, at a minimum, would be sufficient.**

ACKNOWLEDGMENT: Each Proposer shall acknowledge receipt of this Addendum No. 2 by his or her signature below, and shall attach a copy of this Addendum to its proposal.

CERTIFICATION BY PROPOSER

The undersigned acknowledges receipt of this Addendum No. 2 and the Proposal submitted is in accordance with information, instructions, and stipulations set forth herein.

PROPOSER: PRIDE Enterprises

BY: 

DATE: March 31, 2017



Issue Date: March 2, 2017

*No Pre-Bid Conference will be held.
Question Submittal Deadline is March 23, 2017.*

Bid Due Date: April 5, 2017 @ 3:00 p.m. local time

INVITATION TO BID
BID NO. RTSX-180002-DS
BUS STOP AMENITIES

Purchasing Representative:
Daphne Sesco, Senior Buyer
Purchasing Division
Phone: (352) 334-5021
Fax: (352) 334-3163
Email: sescoda@cityofgainesville.org

City of Gainesville
200 East University Avenue, Room 339 – Gainesville, Florida 32601

TABLE OF CONTENTS

SECTION I – INSTRUCTION TO BIDDERS	4
1. Definition of Terms	5
2. Specifications	5
3. Bond Requirements	5
4. Preparation of Bids	6
5. Contact Person	6
6. Qualifications of Bidders	6
7. Receipt and Opening of Bids	7
8. Consideration of Bids and Award of Contract	7
9. Performance	7
10. Collusion	7
11. Addenda	8
12. Trade Secret and/or Confidential and/or Proprietary Information	9
SECTION II – GENERAL CONDITIONS	9
1. Scope	9
2. Cancellation	9
3. Delay	9
4. Bids	9
5. Eligibility of Equipment or Materials	10
6. Deviations From Specifications	10
7. Warranty	10
8. Errors	10
9. Payment	11
10. Notices	11
11. Insurance	11
12. Non-Assignment/Subcontractors	12
13. Public Entity Crime Information statement	12
14. Local Small Business Participation – NOT APPLICABLE	12
15. Sovereign Immunity	12
16. Local Preference – NOT APPLICABLE	12
17. Records/Audits	12
18. Investigation of Alleged Wrongdoings, Litigation/Settlements/Fines/Penalties	13
19. Tie Bids	13
20. Indemnification	13
21. Rights of Appeal	13
22. Joint Bidding/Cooperative Purchasing Agreement	13
23. Disputes	13
24. Florida Public Records Act	15
SECTION III – SPECIAL PROVISIONS	15
1. Scope	15
2. Term of Purchasing Agreement	15
3. Delivery Schedule	15
4. Delivery Location	15
5. Inquiries	15
6. Insurance	16
7. Subcontractors	16
8. Local Preference – NOT APPLICABLE	16
9. Small Business Procurement Program – NOT APPLICABLE	17
SECTION IV – TECHNICAL SPECIFICATIONS	34
BID FORM	37
TABULATION OF SUBCONTRACTORS AND MATERIAL SUPPLIERS	38
DRUG FREE WORKPLACE FORM	39
DEBARRED AND SUSPENDED BIDDERS	43
LOCAL SMALL BUSINESS PROGRAM	46
PURCHASING DIVISION SURVEY	46

**City of Gainesville
General Government Purchasing
Invitation to Bid**

DATE: March 2, 2017

BID #: RTSX-180002-DS

BID NAME: Bus Stop Amenities

BID DATE: April 5, 2017
@ 3:00 p.m. local time

Sealed bids will be received by the City of Gainesville, Florida, at General Government Purchasing until 3:00 p.m., local time, on the bid date, at which time and place all bids will be publicly opened and will be available for inspection upon notice of award or intended award or within 30 days after bid opening, whichever is earlier. If special accommodations are needed in order to attend a pre-bid conference or a bid opening, please contact the Purchasing Division at least 72 hours in advance. Bid prices may be read at the public bid opening, at the sole discretion of General Government Purchasing. Bids must be in the possession of General Government Purchasing prior to bid call at 3:00 p.m. on the bid date. Possession is defined as being physically received in General Government Purchasing at City Hall, 200 East University Avenue, Room 339, Gainesville, Florida 32601. The time clock located in General Government Purchasing will be the official time for bid call. Bids shall be sealed and plainly marked on the outside of the envelope with both the bid number and the bid name. **ANY BID RECEIVED IN GENERAL GOVERNMENT PURCHASING AFTER THE SPECIFIED TIME WILL NOT BE CONSIDERED.** Bids must be completed and signed in ink in space[s] provided on the enclosed bid form(s) and **submitted in triplicate** or bid will be subject to rejection. In addition, proposer should provide one (1) electronic copy of their bid in PDF format on a CD or USB flash drive. Electronic document should not be password protected, encrypted, etc. Delivery of merchandise shall be F.O.B. Gainesville, Florida. The point of delivery will be specified on the purchase order or other notification of acceptance. Please note that if bonds are required, they must be in the approved form attached to the specifications or the bid will be subject to rejection.

Any deviation from the specifications must be explained in detail on sheets attached to the Bid Form and labeled "Clarifications and Exceptions", and each deviation must be itemized by number and must specifically refer to the applicable specification paragraph and page. Otherwise, it will be considered that items offered are in strict compliance with these Specifications and the successful Bidder will be held responsible for meeting the Specifications. A Bidder who is aggrieved in connection with the specifications of this bid must advise General Government Purchasing in writing prior to the opening of bids. If Bidder wishes its Standard Terms and Conditions to be considered as part of its bid, such terms and conditions must be made part of the "Clarifications and Exceptions." The City reserves the following rights: to waive clarifications and exceptions in awarding the bid in the best interest of the City; to accept or reject any or all bids; to waive any or all irregularities; and to award the contract to the most responsible and responsive Bidder whose bid is determined by the City to be in its best interest. Notice of intended award shall be posted at 200 East University Avenue, 3rd floor, Gainesville, Florida. Protests of the intended award must be filed within five business days of posting for purchases which do not require prior approval of the City Commission and within five business days for purchases which require prior approval of the City Commission. It is the Bidder's responsibility to inform himself of intended award and specific protest procedures.

Daphyne Sesco, Senior Buyer
General Government Purchasing
(352) 334-5021

SECTION I – INSTRUCTION TO BIDDERS

1. Definition of Terms

- 1.1 Authorized Representative: Any representative of the City, whether or not a City employee, designated as the City's Authorized Representative for the purposes of this Contract either in a provision of these Specifications or in written communication from the City Manager to the Contractor.
- 1.2 Bidder: Any person, firm, corporation, organization or agency submitting a bid for the work proposed, or its duly authorized representative.
- 1.3 City: City of Gainesville, Florida, or an Authorized Representative.
- 1.4 Commercially Useful Function: A DBE performs a commercially useful function when it is responsible for execution of the work of the contract and is carrying out its responsibilities by actually performing, managing, and supervising the work involved. To perform a commercially useful function, the DBE must also be responsible, with respect to materials and supplies used on the contract, for negotiating price, determining quality and quantity, ordering the material, and installing (where applicable) and paying for the material itself. To determine whether a DBE is performing a commercially useful function, you must evaluate the amount of work subcontracted, industry practices, whether the amount the firm is to be paid under the contract is commensurate with the work it is actually performing and the DBE credit claimed for its performance of the work, and other relevant factors. (49 C.F.R. § 26.55)
- 1.5 Construction Services: All labor, services, and materials provided in connection with the construction, alteration, repair, demolition, reconstruction, or an other improvements to real property.
- 1.6 Contract or Agreement: The Contract executed by the Owner and Contractor for the performance of the work. The Contract shall be substantially in the form provided in these Specifications or by purchase order incorporating the provision of the Specifications.
- 1.7 Contractor: The person, firm, corporation, organization or agency with whom the City has executed a contract for performance of the work or supply of equipment or materials, or its duly authorized representative.
- 1.8 Control: Means having the primary power, direct or indirect, to influence the management of a business enterprise. The controlling party must have the demonstrable ability to make independent and unilateral business decisions on a day-to-day basis, as well as the independent and unilateral ability to make decisions which may influence and chart the future course of the business. In determining whether socially and economically disadvantaged owners control a firm the City may utilize the criteria in 49 CFR Part 23 & 26, Section 26.71.
- 1.9 Disadvantaged Business Entity (DBE): A for-profit small business concern: (1) That is at least 51 percent owned by one or more individuals who are both socially and economically disadvantaged, or, in the case of a corporation, 51 percent of the stock of which is owned by one or more such individuals; and (2) Whose management and daily business operations are controlled by one or more of the socially and economically disadvantaged individuals who own it. (26 CFR Part 265)
- 1.10 Laws and Regulations. Laws or Regulations—Any and all applicable laws, rules, regulations, ordinances, codes and orders of any and all governmental bodies, agencies, authorities, and courts having jurisdiction.
- 1.11 Local Business: The vendor has a valid business tax receipt, issued by the City of Gainesville, to do business in said locality that authorizes the business to provide the goods, services, or construction to be purchased, and a physical business address located within the limits of said locality, in an area zoned for the conduct of such business, from which the vendor operates or performs business on a day-to-day basis. Post office boxes are not verifiable and shall not be used for the purpose of establishing said physical address. In order to be eligible for local preference, in the Bid or RFP evaluation, the vendor must provide a copy of the business tax receipt and Zoning Compliance Permit. Exhibit -A-(Attach Codified document). The business tax receipt must be issued at least six months prior to bid or proposal opening date.
- 1.12 Local Small Business: A Small Business, which is duly licensed and authorized to engage in business and maintains a permanent principal place of operation with full time personnel within the corporate limits of the City of Gainesville and

possess a current City business tax receipt, and is so certified by the Local Small Business Program Procurement Coordinator.

- 1.13 Material Supplier: (also Supplier) a manufacturer, fabricator, supplier, distributor, materialman, or vendor having a direct contract with Contractor or with any Subcontractor to furnish materials or equipment to be incorporated in the Work by Contractor or any Subcontractor.
- 1.14 Specifications: Directions, provisions, and requirements contained in the Invitation to Bid, Instructions to Bidders, Special Provisions, General Conditions, Technical Specifications (if any), Supplementary Conditions (if any), Bid Form, Bids (if any), together with any written contract made or to be made setting out or relating to the methods and manner for the work to be carried out.
- 1.15 Subcontractor: An individual or entity having a direct contract with Contractor or with any other Subcontractor for the performance of a part of the Work at the site.
- 1.16 Supplier: (also Material Supplier) A manufacturer, fabricator, supplier, distributor, materialman, or vendor having a direct contract with Contractor or with any Subcontractor to furnish materials or equipment to be incorporated in the Work by Contractor or any Subcontractor.
- 1.17 Work: The entire completed construction or the various separately identifiable parts thereof required to be provided under the Contract Documents. Work includes and is the result of performing or providing all labor, services, and documentation necessary to produce such construction, and furnishing, installing, and incorporating all materials and equipment into such construction, all as required by the Contract Documents.

2. Specifications

- 2.1 All sections of the Specifications and all supplementary documents are essential parts of the Contract and requirements occurring in one are as though occurring in all. These Specifications and documents in their entirety shall be included in, and made a part of, the Contract between the City and the successful Bidder.
- 2.2 If there is any conflict between the terms and conditions contained in the Specifications, the precedence of the Specifications shall be as follows:

- (a) contract
- (b) addenda or modifications of any nature, if any
- (c) supplementary conditions, if any
- (d) technical specifications, if any
- (e) special provisions
- (f) general conditions
- (g) instructions to bidders
- (h) bid form
- (i) invitation to bid

- 2.3 Any Bidder in doubt as to the true meaning of any part of the Specifications or related documents may submit a written request to the City for interpretation thereof. Any interpretation to a bidder will be made only by an addendum duly issued and a copy of such addendum will be mailed or delivered to each Bidder receiving a set of documents.
- 2.4 A vendor who is aggrieved in connection with the specifications of this bid, may protest in writing to the city of Gainesville Purchasing Division prior to the opening of bids.

3. Bond Requirements

Bond requirements are detailed in the sections entitled Special Provisions.

4. Preparation of Bids

- 4.1 Bids shall be submitted in triplicate on the prescribed form provided in these Specifications. All copies must be plainly marked by the Bidder who will be responsible for their correctness. All blank spaces must be filled in as noted in ink or type.

Any erasures or corrections must be initialed in ink by the Bidder. In addition, proposer should provide one (1) electronic copy of their bid in PDF format on a CD or USB flash drive. Electronic document should not be password protected, encrypted, etc.

- 4.2 Only one bid from any individual, firm, corporation, organization or agency under the same or different name shall be considered. Should it appear to the City that any Bidder is interested in more than one bid, all bids in which such Bidder has interest will be rejected.
- 4.3 Bids shall be accompanied with the attached Tabulation of Subcontractors & Suppliers form, listing the Subcontractors and Material Suppliers which the Bidder proposes to employ.
- 4.4 Any deviation from these Specifications must be explained in detail. Otherwise, it will be considered that labor, materials and equipment bid are in strict compliance with these Specifications and the successful Bidder will be held responsible for meeting those Specifications. Any exceptions or clarifications to any section of the Specifications shall be clearly indicated on a separate sheet(s) attached to the Bid Form and shall specifically refer to the applicable specification paragraph and page.
- 4.5 A Bidder is expected to fully inform itself as to the requirements of the Specifications and failure to do so will be at its own risk. A Bidder shall not expect to secure relief on the plea of error.

5. Contact Person

To ensure fair consideration and consistent and accurate dissemination of information for all proposers, the City prohibits communication to or with any department, employee, or agent evaluating or considering the proposals during the submission process, except as authorized by the contact person.

During the blackout period as defined herein, except as pursuant to an authorized appeal, no person may lobby, as defined herein, on behalf of a competing party in a particular procurement process, City officials or employees except the purchasing designated staff contact in the purchasing division. Violation of this provision shall result in disqualification of the party on whose behalf the lobbying occurred.

The blackout period means the period between the issue date which allows for immediate submittals to the City of Gainesville Purchasing Department for an invitation for bid or the request for proposal, or qualifications, or information, or the invitation to negotiate, as applicable, and the time the City Officials and Employee awards the contract. Lobbying means when any natural person, for compensation, seeks to influence the governmental decision-making, to encourage the passage, defeat or modification of any proposal, recommendation or decision by City officials and employees, except as authorized by procurement documents.

6. Qualifications of Bidders

- 6.1 The City reserves the right to make such investigations as it may deem necessary to establish the competency and financial ability of any Bidder to perform the work.
- 6.2 If, after the investigation, the evidence of competency and financial ability is not satisfactory, the City reserves the right to reject the bid.

7. Receipt and Opening of Bids

- 7.1 All bids must be submitted in a sealed envelope, addressed, and mailed or delivered as stated in the Invitation to Bid. Any Bidder may withdraw its bid either personally, or by telegraphic or written communication at any time prior to the scheduled closing time for the bid.
- 7.2 The Bidder shall submit its bid on the form furnished with all indicated information filled in on the form. Bids shall be in the units specified for each item. The Bidder shall enter the company name wherever the Bid Form so indicates and shall sign the Bid Form wherever the Bid Form so indicates.
- 7.3 Bids shall be publicly opened at the time and place indicated in the Invitation to Bid and will be available for inspection upon notice of award or intended award or within 30 days after bid opening, whichever is earlier.

8. Consideration of Bids and Award of Contract

- 8.1 If the Contract is awarded, the City will accept the bid and award the Contract to the successful Bidder(s) within sixty (60) days after the opening of the Bids by written notice to the successful Bidder(s). The City reserves the right to award this bid on the basis of each line individually, any combination of line items or all line items combined as it determines to be in its best interest. The City reserves the right to not award any line item as it determines to be in its best interest.
- 8.2 Failure on the part of the successful Bidder to execute a Contract within fifteen (15) days after the notice of acceptance shall be just cause for annulment of award. The City may then accept the bid of the next best evaluated bid or re-advertise for bid.
- 8.3 If the bid of the next best Bidder is accepted, this acceptance shall bind such Bidder as though he were the original successful Bidder
- 8.4 City reserves the right to award the contract to other than the low Bidder for such reasons as acceptability of specific products or designs, delivery times, warranties, past performance, unacceptable deviations or exceptions taken to these Specifications or degree of compliance with any other requirement of these Specifications. Further, City shall have the right to consider price, quality, past performance including compliance with Local Small Business Procurement Program requirements, time required for performance and qualifications of the Bidder in making the award.
- 8.5 Tie Bids. Whenever two or more bids which are equal with respect to price, quality and service are received, preference shall be given in the following order: (1) Bidders submitting the attached Drug-Free Workplace form with their bid/proposal certifying they have a drug free workplace in accordance with Section 287.087, Florida Statutes; (2) Bidders located within the City of Gainesville, if not subject to the Local Preference Ordinance; (3) Bidders located within Alachua County; and (4) Bidders located within the State of Florida. In projects where federal funds are used for the services, articles 2, 3 and 4 will not apply.
- 8.6 The City of Gainesville reserves the right to accept or reject any or all bids, reserves the right to waive any or all irregularities, and to award the contract to the responsible and responsive Bidder whose bid is determined by the City to be in its best interest.
- 8.7 Any contract resulting herefrom shall not be effective until fully executed by all parties.

9. Performance

- 9.1 All material and parts shall be bid F.O.B. Gainesville, Florida, at the job site.
- 9.2 The performance time may be a factor in the evaluation of the Bid. The performance time shall be defined as the anticipated time period expected to elapse between receipt of the purchase order or execution of the Contract and completion of the work. It is to be emphasized that the meeting of specified performance schedules is a significant part of ability to perform and that failure to meet such schedule may result in termination of the Contract and will surely be considered in the evaluation of future bids.

10. Collusion

- 10.1 The bid shall be made without any previous understanding, agreement, or connections with any persons, firms, or corporations making a bid on the same items and shall be in all respects fair and in good faith without any outside control, collusion or fraud.
- 10.2 No City Commissioner, other City officer, or City employee shall directly or indirectly own more than five (5) percent of the total assets or capital stock of the bidding entity, nor will such person directly or indirectly benefit by more than five (5) percent from the profits or emoluments of this contract. For purposes of this section, indirect ownership or benefit does not include ownership or benefit by a spouse or minor child.

11. Addenda

Addenda issued by City prior to the bid opening shall be binding as if written into the Specifications. Bidders shall acknowledge receipt of the same as indicated on the Bid Form.

12. Trade Secret and/or Confidential and/or Proprietary Information

All proposals (including all documentation and materials attached to proposals or provided in connection with this ITB) submitted to the City are subject to Florida's public records laws (i.e., Chapter 119, Florida Statutes), which requires disclosure of public records, unless exempt, if a public records request is made. Proposals (including all documentation and materials attached to proposals or provided in connection with this RFP (even if in a separate envelope)) submitted to the City cannot be returned. The City will not consider proposals if the entire proposal is labeled a Trade Secret and/or Confidential and/or Proprietary.

If proposer believes that its proposal contains information that is a trade secret (as defined by Florida law) and/or information that is confidential and/or proprietary and therefore exempt from disclosure then such information must be submitted in a separate envelope and comply with the following requirements. In addition to submitting the information in a separate envelope, proposer must include a general description of the information designated as a trade secret and/or confidential and/or proprietary and provide reference to the Florida statute or other law which exempts such designated information from disclosure in the event a public records request.

The City does not warrant or guarantee that information designated by proposer as a trade secret and/or confidential and/or proprietary is a trade secret and/or confidential and/or proprietary and exempt from disclosure. The City offers no opinion as to whether the reference to the Florida statute or other law by proposer is/are correct and/or accurate. The City will notify proposer if a public records request is received and proposer, at its own expense, will have forty-eight (48) hours after receipt of such notice (email notice is acceptable notice) to file the necessary court documents to obtain a protective order.

Please be aware that the designation of information as a trade secret and/or confidential and/or proprietary may be challenged in court by any person or entity. By designation of information as a trade secret and/or confidential and/or proprietary proposer agrees to defend the City, its employees, agents and elected and appointed officials ("Indemnified Parties") against all claims and actions (whether or not a lawsuit is commenced) related to its designation of information as a trade secret and/or confidential and/or proprietary and to hold harmless the Indemnified Parties for any award to a plaintiff for damages, costs and attorneys' fees, and for costs and attorneys' fees (including those of the City Attorney's office) incurred by the City by reason of any claim or action arising out of or related to proposer's designation of information as a trade secret and/or confidential and/or proprietary.

Failure to comply with the requirements above shall be deemed as a waiver by proposer to claim that all additional information in its proposal is a trade secret and/or confidential and/or proprietary regardless if such information is labeled trade secret and/or confidential and/or proprietary. Proposer acknowledges and agrees that all information in proposer's proposal (not including information in Section 12. will be disclosed, without any notice to proposer, if a public records request is made for such information.

Please be advised that proposer's proposal, including the information submitted in a separate envelope in accordance with the requirements set forth in this Section 12., will be distributed to the Evaluation Committee members, City staff and City Consultants to allow proposer's entire proposal, including the information submitted in a separate envelope, to be evaluated and considered for award of this Contract. The entire contents of Proposer's proposal, including the information submitted in a separate envelope, may be discussed at meetings that are open to the public, subject to the requirements set forth in Chapter 286, Florida Statutes. In the event a public records request is received the City will notify Proposer and Proposer, at its own expense, will have forty-eight (48) hours after receipt of such notice (e-mail notice is acceptable notice) to file the necessary court documents to obtain a protective order.

SECTION II – GENERAL CONDITIONS

1. Scope

These General Conditions shall govern purchases by the City of Gainesville under these Specifications, except that Special Provisions and Technical Specifications, whether provided by separate section attached hereto or stated in the Invitation to Bid, will govern if any conflict arises between such sections and these General Conditions.

2. Cancellation

The City reserves the right to cancel any purchasing agreement arising out of an award under these Specifications if, in its opinion, there is any failure to adequately perform the requirements of these Specifications. Under these conditions, cancellation will be effective immediately upon written notification to the vendor and such cancellation will relieve the City from any obligation to purchase any items under such purchasing agreement.

3. Delay

3.1 Notwithstanding the delivery schedule, the City shall have the right to delay the delivery for up to three months as necessary or desirable and such delay shall not be deemed a breach of contract, but the delivery schedule shall be extended for a period equivalent to the time lost by reason of the City's delay.

3.2 If the project for which the delivery is required is stopped or delayed for more than three months, either in whole or in substantial part, and either the City or Vendor elects to terminate the Contract because of such delay, if such stoppage or delay is due to actions taken by the City within its control, Vendor's sole remedy under the Contract shall be reimbursement for costs reasonably expended in preparation for or in performance of the contract. Vendor shall not be entitled to lost profit.

3.3 If the performance of the Contract is delayed by fire, lightning, earthquake, cyclone, or other such cause completely beyond the control of either the City or the Vendor, then the time for completion of the Contract shall be extended for a period equivalent to the time lost by reason of any of the aforesaid causes.

4. Bids

4.1 All discounts shall be stated as a part of the bid and shall be fully explained. Prompt payment discounts shall not be considered in the award of the bid.

4.2 Bids shall be considered based on the following priority:

4.2.1 First, only those bids which are firm for the contract period.

4.2.2 Second, those bids which are not firm but which specify a guaranteed maximum price adjustment for the contract period will be considered at the maximum level the price could possibly obtain.

4.3 Late payment penalties, if any, shall be listed as Clarifications and Exceptions to paragraph 4.4 and shall not be included as a part of the quotation.

4.4 The price shall be determined by the price in effect on the date an order is placed. The City shall not be responsible for any additional charges not accepted by the City, and any invoicing at variance with this provision shall be grounds for cancellation of the Contract at the option of the City.

5. Eligibility of Equipment or Materials

5.1 When a particular manufacturer's name and catalog number "or equivalent" is specified, consideration will be given to other manufacturers. The term "or equivalent" shall be defined to mean of similar design and performance characteristics. If a product is being bid as an equivalent, complete technical data necessary to properly evaluate such product shall be submitted with the bid.

- 5.2 The City reserves the right to request additional data after the bid is opened and prior to the award. Failure to supply data necessary to properly evaluate a product will constitute sufficient reason for rejection of the bid.
- 5.3 All information specifically requested by this Specification shall be furnished attached to the bid. Failure to do so may invalidate the bid.

6. Deviations From Specifications

- 6.1 Any deviation from these Specifications must be explained in detail. Otherwise, it will be considered that items offered are in strict compliance with these Specifications and the successful bidder will be held responsible for meeting these Specifications. Deviations must be explained on separate sheets attached to the bid, labeled Clarifications and Exceptions and each must be itemized by number and must refer to the applicable specification paragraph and page.
- 6.2 The City reserves the right to waive clarifications and exceptions in awarding the bid in the best interest of the City.
- 6.3 Equipment or materials supplied by award of this bid which does not comply with the Specifications shall be subject to return by the City at the expense of the vendor. Credit in an amount equal to the cost of the equipment or materials, plus any delivery charges resulting from such return, shall be made to the applicable City account. The City shall have a 60 day period following receipt of equipment to make notifications of non-conformance.

7. Warranty

- 7.1 The bidder shall indicate on the Bid Form if any warranty is being provided by either itself or a manufacturer, and if any such warranty is being provided, such warranty shall be stated on the Bid Form or attached thereto and submitted as part of the bid.
- 7.2 When the manufacturer normally warrants the equipment or materials being supplied, the vendor shall provide such warranty to the City or shall state as a Clarification and Exception the reason the vendor is not able to provide such warranty.

8. Errors

The Bidder shall read the Specifications fully and be informed as to the requirements of these Specifications. Failure to do so will be at Bidder's own risk. A Bidder shall not be relieved of a requirement of these Specifications on the plea of error.

9. Payment

- 9.1 Invoicing. The contractor shall be responsible for invoicing the City for payment as described below.
- 9.2 Payment. Payment will be due to the Contractor thirty (30) days after receipt of the invoice, provided that Contractor shall not submit more than one invoice per thirty-day period. Payment may be withheld by the City due to failure by the Contractor to comply with these Specifications or because unacceptable equipment or materials were delivered as determined by the City's inspection or failure by the Contractor to comply with the "Prompt Payment: Late Payments by Contractors to Subcontractors and Material Suppliers; penalty:" clause. The City shall notify the Contractor of any unsatisfactory performance as soon as practicable so that it can be corrected without delaying payment if possible.
- Contractor payment by City issued procurement card (currently VISA) is preferred. Otherwise, contractor will be paid electronically as an electronic funds transfer (EFT).
- 9.3 Prompt Payment Assurance: Late Payments by Contractors to Subcontractors and Material Suppliers; penalty: When a Contractor receives from the City of Gainesville any payment for contractual services, commodities, materials, supplies, or construction contracts, the Contractor shall pay such moneys received to each subcontractor and Material Supplier in proportion to the percentage of Work Completed by each Subcontractor and Material Supplier at the time of receipt. If the Contractor receives less than full payment, then the Contractor shall be required to disburse only the funds received on a pro rata basis with the Contractor, Subcontractors, and Material Suppliers, each receiving a prorated portion based on the amount due on the payment. If the Contractor without reasonable cause fails to make payments required by the section to Subcontractors and Material Suppliers within 10 days after the receipt by the Contractor of full or partial payment, the Contractor shall pay to the Subcontractors and Material Suppliers a penalty in the amount of 1 percent of the amount due, per month, from the expiration of the period allowed herein for payment. Such penalty shall be in addition to actual payment

owed. Retainage is also subject to this prompt payment requirement and must be returned to the Subcontractor or Material Supplier whose Work has been completed, even if the prime contract has not been completed. The Contractor shall include the above obligation in each subcontract it signs with a Subcontractor or Material Supplier.

- 9.4 Records of progress payment made by prime contractors to Subcontractors or Material Suppliers are required at least on a monthly basis. However, information can be submitted more frequently than monthly.
- 9.5 For a contract for construction services, the City and Contractor agree to abide by the regulations stated in Section 218.735, F.S. of the Local Government Prompt Payment Act.

10. Notices

- 10.1 Notices to the Contractor pursuant to these Specifications shall be deemed to have been properly sent when mailed to the Contractor at the address provided on the Bid Forms.
- 10.2 Notices to the City shall be deemed to have been properly sent when mailed to the Purchasing Manager of the City at the address stated for the mailing of bids on the Invitation to Bid.

11. Insurance

- 11.1 Owners and Subcontractors Insurance. The Contractor shall procure and maintain worker’s compensation insurance to the extent required by Florida Statute 440 for all his employees to be engaged in work under this Contract.
- 11.2 Public Liability Insurance. The Contractor shall procure and shall maintain broad form comprehensive general liability insurance (including contractual coverage) and comprehensive automobile liability insurance in the amounts shown in the Special Provisions section. The City shall be an additional insured on this insurance with respect to all claims arising out of the operations or work to be performed.

Comprehensive General (Public) Liability (other than automobile):

- B) Premises/Operations
- C) Independent Contractors
- D) Products/Completed Operations
- E) Personal Injury
- F) Contractual Liability
- G) Explosion, collapse and underground property damage (unless such coverage is excluded in the Special Provisions section)
- H) Contractor’s Pollution

Comprehensive Automobile Bodily Injury and Property Damage Liability

- A) Owner/Leased Automobiles
- B) Non-Owned Automobiles
- C) Hired Automobiles

- 11.3 Proof of Carriage of Insurance. The Contractor shall furnish the City a Certificate of Insurance in a form acceptable to the City for the insurance required. Such certificate or an endorsement provided by the Contractor must state that the City will be given thirty days written notice (except the City will accept ten (10 days written notice for non-payment) prior to cancellation or material change in coverage.

12. Non-Assignment/Subcontractors

- 12.1 The Contractor shall not assign or subcontract in whole or in part any right or obligation under this Contract; or any monies due or to become due thereunder without the written consent of the City.
- 12.2 The Contractor must notify the City in writing of any intention to assign or subcontract and no assignment shall occur or subcontractor shall be employed without the written approval of the City.

- 12.3 If the City grants written consent, the Contractor shall be as fully responsible to the City for acts and omissions of persons directly or indirectly employed by him as he is for the acts and omissions of persons strictly employed by him.

13. Public Entity Crime Information statement

A person or affiliate who has been placed on the convicted vendor list following a conviction for a public entity crime may not submit a bid, proposal, or reply on a contract to provide any goods or services to a public entity; may not submit a bid, proposal, or reply on a contract with a public entity for the construction or repair of a public building or public work; may not submit bids, proposals, or replies on leases of real property to a public entity; may not be awarded or perform work as a contractor, supplier, subcontractor, or consultant under a contract with any public entity; and may not transact business with any public entity in excess of the threshold amount provided in s. 287.017 for CATEGORY TWO for a period of 36 months following the date of being placed on the convicted vendor list. (F.S. Ann. § 287.133)

14. Local Small Business Participation – **NOT APPLICABLE**

Policy. It is the policy of the City of Gainesville that local small businesses as defined in the City of Gainesville's Local Small Business Procurement Program Policies and Procedures (the policy) shall have the maximum practical opportunity to participate in the competitive process of supplying commodities and services to the City. A listing of qualified businesses is located on the City's website at:

[http://www.cityofgainesville.org/Portals/0/eo/Small_SDV%20Business%20Listing%20\(1.28.16\).pdf](http://www.cityofgainesville.org/Portals/0/eo/Small_SDV%20Business%20Listing%20(1.28.16).pdf)

Notification is hereby given that local small businesses are strongly encouraged to submit a proposal for this bid.

Enforcement of Program. Any individual or entity that engages in fraud, misrepresentation, or other wrongful conduct, whether by act or omission, related to its participation in or eligibility to participate in the City's Local Small Business Procurement Program or in the performance of its small business obligations under a City contract, shall be in violation of the Program. This determination shall be solely at the decision of the City.

Violators of the City's Local Small Business Procurement Program may be subject to, on an individual and/or entity basis, the debarment or suspension from participating in the City's contracts in accordance with the City of Gainesville's Debarment and Suspension Policy.

15. Sovereign Immunity

Nothing in the contract shall be interpreted that the City waives its sovereign immunity granted under Section 768.28, Florida Statutes.

16. Local Preference – **NOT APPLICABLE**

In bidding of, or letting contracts for procurement of, supplies, materials, equipment and services, as described in the purchasing policies, the city commission, or other purchasing authority, may give a preference to local businesses in making such purchase or awarding such contract in an amount not to exceed five percent of the local business' total bid price, and in any event the cost differential should not exceed \$25,000.00.

17. Records/Audits

Contractor shall maintain records sufficient to document their completion of the scope of services established by this Contract. These records shall be subject at all reasonable time to review, inspect, copy and audit by persons duly authorized by the City. These records shall be kept for a minimum of three (3) years after completion of the Contract. Records which relate to any litigation, appeals or settlements of claims arising from performance under this Order shall be made available until a final disposition has been made of such litigation, appeals, or claims.

18. Investigation of Alleged Wrongdoings, Litigation/Settlements/Fines/Penalties

The City Commission specifically requests that responders to this document indicate in writing any investigations of wrongdoings, litigation and/or settlements, and fines or penalties (anywhere in the U.S) involving the Contractor and specific

Contractors listed as projected to provide services to the City. You may be required to respond to questions on this subject matter.

19. Tie Bids

Whenever two or more bids which are equal with respect to price, quality and service are received, preference shall be given in the following order: (1) Bidders submitting the attached Drug-Free Workplace form with their bid/proposal certifying they have a drug free workplace in accordance with Section 287.087, Florida Statutes; (2) Bidders located within the City of Gainesville, if not subject to the Local Preference Ordinance; (3) Bidders located within Alachua County; and (4) Bidders located within the State of Florida. In the case where Federal funds are being utilized, articles 2, 3 and 4 will not apply.

20. Indemnification

The Contractor shall indemnify, defend, and hold harmless the City, its officers, agents, and employees, from liabilities, damages, losses, and costs, including, but not limited to, reasonable attorney's fees, to the extent caused by the negligence, recklessness, or intentional wrongful misconduct of the contractor and other persons employed or utilized by the Contractor in the performance of the work.

21. Rights of Appeal

Participants in this Invitation to Bid solicitation may protest Invitation to Bid specifications or award in accordance with Section 41-580 of the City of Gainesville's Financial Procedures Manual.

22. Joint Bidding/Cooperative Purchasing Agreement

Cooperative Purchasing Agreement: All bidders submitting a response to this invitation to bid agree that such response also constitutes a bid to all State Agencies and Political Subdivisions of the State of Florida under the same terms and conditions, for the same prices and the same effective period as this bid, should the bidder deem it in the best interest of its business to do so. This agreement in no way restricts or interferes with any State Agency or Political Subdivision of the State of Florida to rebid any or all items.

23. Disputes

Except as otherwise provided in this Contract, any dispute concerning a question of fact or of interpretation of a requirement of the Contract which is not disposed of by mutual consent between the parties shall be decided by the City Manager or designee, who shall reduce the decision to writing and furnish a copy thereof to the parties. In connection with any dispute proceeding under this clause each party shall be afforded an opportunity to be heard and to offer evidence in support of its version of the facts and interpretation of the Contract. The City Manager or designee shall make such explanation as may be necessary to complete, explain or make definite the provisions of this Contract and the findings and conclusions shall be final and binding on both parties. Pending the final decisions of a dispute hereunder, Contractor shall proceed diligently with its performance of the Contract in accordance with the preliminary directions of the City Manager or designee.

24. Florida Public Records Act

Florida has a very broad public records law and certain records of a contractor may be considered public records. Accordingly, by entering into an agreement with the City, contractor must:

1. Keep and maintain public records required by the public agency to perform the service.
2. Upon request from the public agency's custodian of public records, provide the public agency with a copy of the requested records or allow the records to be inspected or copied within a reasonable time at a cost that does not exceed the cost provided in this chapter or as otherwise provided by law.
3. Ensure that public records that are exempt or confidential and exempt from public records disclosure requirements are not disclosed except as authorized by law for the duration of the contract term and following completion of the contract if the contractor does not transfer the records to the public agency.
4. Upon completion of the contract, transfer, at no cost, to the public agency all public records in possession of the contractor or keep and maintain public records required by the public agency to perform the service. If the contractor

transfers all public records to the public agency upon completion of the contract, the contractor shall destroy any duplicate public records that are exempt or confidential and exempt from public records disclosure requirements. If the contractor keeps and maintains public records upon completion of the contract, the contractor shall meet all applicable requirements for retaining public records. All records stored electronically must be provided to the public agency, upon request from the public agency's custodian of public records, in a format that is compatible with the information technology systems of the public agency.

IF THE CONTRACTOR HAS QUESTIONS REGARDING THE APPLICATION OF CHAPTER 119, FLORIDA STATUTES, TO THE CONTRACTOR'S DUTY TO PROVIDE PUBLIC RECORDS RELATING TO THIS CONTRACT, CONTACT THE CUSTODIAN OF PUBLIC RECORDS AT (TOM QUIGLEY, 352-393-7820, QUIGLEYT1@CITYOFGAINESVILLE.ORG, PO BOX 490 STATION 5, GAINESVILLE FL 32627).

SECTION III – SPECIAL PROVISIONS

1. Scope

These Special Provisions shall supplement the General Conditions and shall govern purchases by the City of Gainesville under these Specifications, except that Technical Specifications, whether provided by separate section attached hereto, or stated in the Invitation to Bid, will govern if any conflict arises between such technical specifications and these Special Provisions.

2. Term of Purchasing Agreement

- 2.1 These Specifications shall be for the purchase of an estimated quantity of materials ordered on an as-needed basis.
- 2.2 Any bid submitted in response to these Specifications shall be binding for a period of 60 calendar days after the bid opening date.
- 2.3 An award made under these Specifications shall in no way prevent the City of Gainesville from requesting bids on identical or similar items to those covered herein.
- 2.4 The contract period for work under this agreement shall commence upon execution of the contract and shall end on September 30, 2020.

The obligations of the City as to any funding required pursuant to this Agreement shall be limited by an obligation in any given year to budget and appropriate from legally available funds, after monies for essential City services have been budgeted and appropriated sufficient monies for the funding that is required during that year. Notwithstanding the foregoing, the City shall not be prohibited from pledging any legally available non-ad valorem revenues for any obligations heretofore or hereafter incurred, which pledge shall be prior and superior to any obligation of the City pursuant to this Agreement.

3. Delivery Schedule

- 3.1 Meeting specified delivery schedules is of the essence of this Contract and is a significant part of the performance of the Contract. Failure to meet such schedules may result in cancellation of the Contract as described in Section 2 of the General Conditions and will be considered in the evaluation of future bids.
- 3.2 The delivery schedule as used herein and as stated on the Bid Form is hereby defined as the period which will elapse between receipt of a purchase order and the arrival of the equipment at the designated point of delivery.
- 3.3 Time of delivery shall be within the time stated on the bid form.

4. Delivery Location

- 4.1 All equipment shall be bid F.O.B. Gainesville.

5. Inquiries

- 5.1 Any inquiry should be directed to Daphyne Sesco, Senior Buyer, Purchasing Division, 200 University Avenue, Room 339, Gainesville, Florida 32601, (352) 334-5021.

6. Insurance

The Contractor shall furnish the City a Certificate of Insurance in a form acceptable to the City for the insurance required. Such certificate or an endorsement provided by the Contractor must state that the City will be given thirty days written notice (except the City will accept ten (10) days written notice for non-payment) prior to cancellation or material change in coverage.

- (x) Contractor shall be required to maintain sufficient insurance to cover its liability in performance of the contract.
- () The following insurance amounts shall be required (See Section 12, General Conditions for details):

Worker's Compensation insurance providing coverage in compliance with Chapter 440, Florida Statutes.

Comprehensive General (other than automobile)	\$500,000 combined single limit for (Public) Liability bodily injury and property damage.
Automobile Bodily Injury	\$300,000 per individual \$500,000 aggregate
Automobile Property Damage Liability	\$500,000 per occurrence

- Explosion, collapse and underground property damage is required.
- Explosion, collapse and underground property damage is not required.

- Contractor's Pollution liability insurance is required.
- Contractor's Pollution liability is not required.

NOTE: The City of Gainesville shall be named as an additional insured on an insurance certificate in a form which is acceptable to the City.

7. **Subcontractors**

- Subcontractor will be allowed.
- Subcontractor will not be allowed.

8. **Local Preference – NOT APPLICABLE**

A copy of your Business tax receipt and Zoning Compliance Permit should be submitted with the bid if a local preference is requested.

9. **Small Business Procurement Program – NOT APPLICABLE**

The City of Gainesville requires Good Faith Efforts to maximize utilization of Qualified Local Small Businesses for this project. (see Exhibit B).

A listing of qualified businesses is located on the City's website at:
[http://www.cityofgainesville.org/Portals/0/eo/Small_SDV%20Business%20Listing%20\(1.28.16\).pdf](http://www.cityofgainesville.org/Portals/0/eo/Small_SDV%20Business%20Listing%20(1.28.16).pdf)

SECTION IV – TECHNICAL SPECIFICATIONS

1. Scope

The provisions contained in this section are intended to be cooperative with, to supplement, or to modify Instructions to Bidders, Special Provisions and General Conditions and, in case of any conflict with such sections, the intent of any and all Technical Specifications shall govern.

2. Detailed Description of Materials/Work

- 2.1 The City of Gainesville Regional Transit System (RTS) intends to procure a bid for a variety of amenities to install at bus stops to improve the safety, accessibility, and comfort of bus stops. Bus stop amenity improvements are part of RTS's effort to simultaneously enhance its existing transit network and make plans for the expansion of future services. Amenities include items such as bus stop shelters, kiosks, benches, trashcans, and bicycle racks. A well-documented quality assurance (QA) program must be in place that provides a systematic approach for evaluation, inspection, testing, or whatever is needed to monitor and assure the quality of materials, workmanship, and finish shall be required. The period of performance shall be three years. Contractor agrees to sell amenities at the same price and under the terms and conditions of this agreement from the time of contract award to the contract term expiration. The line item unit price(s) of each amenity listed must include all costs that the bidder intends to recover, including freight. It is assumed that the unit price on large orders may decrease due to bulk freight rates and these savings will be passed to the City of Gainesville. All pricing to be firm for the entirety of contract as no price escalations/adjustments will be made.
- 2.2 All furnishings and installations shall comply with all applicable building codes, wind load, and seismic load specifications of the local and state jurisdictions, including the *City of Gainesville Engineering Design, and Construction Manual*¹ and the most current standards set forth by the American Society for Testing² and Materials and American Welding Society³. All amenities must also be in full compliance with Americans with Disabilities Act (ADA) requirements and should meet the applicable recommendations provided in the *Florida Department of Transportation's (FDOT) Accessing Transit Design Handbook for Florida Bus Passenger Facilities Version III 2013*⁴.
- 2.3 Quantities
- The work under this contract consists of the provision of bus stop amenities.
- RTS does not guarantee any purchase quantity with all minimums subject to available funding. Orders shall be placed on an as-needed basis. Estimated quantities are informational and not to be construed as a warranty of accuracy of historical or anticipated volumes. RTS typically purchases a minimum of one and maximum of ten shelters annually.
- 2.4 Community Redevelopment Agency (CRA) Districts
- Bus stop amenities selected to be procured shall adequately satisfy the intent to create a uniform look across the RTS service area but be sensitive to their direct surroundings in terms of material and color. In particular, furnishings in the Community Redevelopment Agency (CRA) Districts meet the standards specified in *Streetscape Design and Technical Standards for City of Gainesville CRA Districts*⁵ or equivalent.
- 2.5 Delivery
- Delivery of amenities shall be within 8-12 weeks after placement of individual purchase orders and shall include the delivery packing slip. The packing slip shall contain the purchase order number and a detailed listing of all materials shipped.
 - Each shipment shall contain installation instructions for all materials with parts clearly identified and fully compliant with all applicable guidelines, as well as all literature from the manufacturer for the delivered products.

¹ <https://www.cityofgainesville.org/Portals/0/pw/engineering/2015%20Engineering%20Design%20Construction%20Manual.pdf>

² <http://www.astm.org/Standard/standards-and-publications.html>

³ <http://www.aws.org/wa/technical/index.html?id=kc9W2QSh>

⁴ <http://www.dot.state.fl.us/mapsandpublications/manuals/puboffice.shtm>

⁵ Uploaded as a separate attachment in Demandstar.

- All hardware shall be prefabricated and prepackaged in knockdown kits for each individual stop improvement; bulk packaging of hardware is not acceptable. All delivered amenities shall be supplied with all necessary hardware for site installation.
- Amenities shall be installed using standard tools and equipment and be designed so that moderately skilled technicians can assemble and install, disassemble, remove, or replace with a limited amount of effort and time.

2.6 Plans and Permits

Contractor shall provide all drawings stamped and sealed by a professional structural engineer, licensed to practice in the State of Florida, confirming compliance with all applicable building codes. Drawings include details for materials, fabrication and assembly, framing profiles, fastener types and locations, accessory components, mounting applications, installation and hardware to ensure all applicable building code standards are met. Drawings shall meet building code requirements for the permitting jurisdiction and be provided in a manner specified by local permitting jurisdictions. Notwithstanding the provision of drawings, technical specifications or other data by RTS, the contractor shall have the responsibility of supplying all parts and details required to make the amenities complete and ready for service even though such details may not be specifically mentioned in the drawings and specifications.

RTS requires 5 full size drawings of each shelter type and amenity with 3 digitally signed CDs.

2.7 Descriptive Literature

- Bidders shall submit descriptive literature for all items that are not described by specific manufacturer, and/or for items that the bidder is offering as an "Equal Brand Name". Descriptive literature must be received by the time specified in this solicitation for receipt of bids, and clearly marked to identify the specific item(s) of the bid to which it applies.
- "Descriptive literature" means information furnished, such as cuts, illustrations, drawings, and brochures that clearly show an item's characteristics, construction, or explains its operation.
- Descriptive literature is used to determine whether the item(s) offered comply with the solicitation requirements. It is used to identify details of the item(s) pertaining to such significant elements as: design, materials, components, performance characteristics, and methods of manufacture, assembly, construction, and/or operation. Descriptive literature includes only that information required to determine the technical acceptability of the offered product. It does not include other information such as that used to determine a prospective contractor's responsibility, or for maintaining the item(s).
- Failure of a bidder to submit descriptive literature on time, or failure of the descriptive literature to clearly show that the item(s) offered, conform to the requirements of this solicitation shall result in rejection of the bid as nonresponsive.

2.8 Equal Product

The items called for in this solicitation are identified by generic description without mention of a brand name. Throughout the specifications, all described features and other requirements are the minimum criteria that shall be acceptable to RTS. Items offered must meet or exceed the minimum criteria. Offers for items that do not satisfy the minimum criteria shall not be considered for award. RTS reserves the right to determine if items offered meet or exceed the minimum criteria. Bidders are required to provide the manufacturer and model number of the unit bid and include the descriptive literature referenced above. Any request for a change to any amenity design requirement of the contract must be fully supported with technical data, test results or other pertinent information showing evidence that the exception shall result in a condition equal to or better than that required by the contract, without a substantial increase in cost or time requirements.

2.9 Interchangeability of Units

- All amenities shall be constructed of modular, interchangeable components to allow for ease of installation and parts replacement.
- All units and components procured under this bid contract, whether provided by suppliers or manufactured by the contractor shall be duplicates in design, manufacture, and installation to assure interchangeability among amenities of the same type in this procurement. This interchangeability shall extend to the individual components of the amenities.

2.10 Spare Parts

The Contractor shall guarantee the availability of replacement parts for these amenities for at least a 10-year period after the date of acceptance. Spare parts shall be interchangeable with the original equipment and shall be manufactured in accordance with the quality assurance provisions of this contract. All replacement part numbers must be provided.

2.11 Installation

RTS's intent is to install all amenities using internal staff.

2.12 Material and Workmanship Quality

Materials furnished and work performed by the contractor shall conform to the requirements of this document. The contractor shall be responsible for all materials and workmanship in the construction of the amenities and all accessories used, whether the same are manufactured by the contractor or purchased from a supplier. Seller hereby warrants that all materials furnished shall meet the requirements and conditions of the contract and shall be fit for the purposes intended. Acceptance of this warranty and acceptance of the materials to be manufactured or assembled pursuant to the specification in these contract documents shall not waive any warranty, either express or implied.

All materials are warranted by the bidder to be new and free from defects in material and workmanship pursuant to and in accordance with manufacturer's warranties; bidder to describe warranty in detail with submission and summarize on product information sheet. During said warranty periods, the materials shall maintain structural and functional integrity. The warranty is based on regular operation under operating conditions prevailing in the purchaser's operating area. All general materials and workmanship shall be guaranteed to be free of defects for a minimum of at least one (1) year (unless explicitly stated differently elsewhere) from date of installation; this includes but is not limited to lifting, peeling, flaking, and corrosion. Any defects shall be repaired or replaced to meet specifications at the expense of the contractor, including freight, parts and labor. Units shall be fabricated only with materials that will not rust or corrode in outdoor installations and will not be affected by any weather conditions. Moreover, all amenities are to be vandal resistant and maintenance free.

3. Amenity Specifications

For all items, it is RTS's expectation that each bidder will use their discretion to provide a single type item for each category that meets all the structural and design requirements outlined in the bid document and that maintain a uniform look between all proposed items.

All items, including optional features, should be individually itemized along with their unit price.

3.1 Shelters

RTS serves a variety of street patterns, building designs and orientations, setbacks, and developable space. Because of the varied conditions, a non-advertising shelter design that can be easily reconfigured, with styles available in various sizes would serve the needs of RTS and its passengers.

3.1.1 Design

3.1.1.1 Universal dimensions:

- Minimum interior clearance of 7' high; maximum height not exceeding 10' high
- Entry and exit points with a minimum clear width of 4'
- Clear floor area 30" x 48" entirely within the perimeter of the shelter; located adjacent to the bench to allow shoulder-to-shoulder seating with a companion

3.1.1.2 Dimensions:

- 8.5' x 4.5' x 8' (Type I)
- 12' x 4.5' x 8' (Type II)
- 16' x 4.5' x 8' (Type III)

3.1.2 Other Considerations

Shelters shall also have:

- Unobstructed views into and out of the approach side.
- Tamper-proof and vandal-resistant system map or kiosk display to accommodate material up to 11"x17" in size; see later section for more information on kiosk design standards.
- A design that maximizes shading and encourages cooling air movement - avoiding impervious side panel materials.
- No gutter, downspouts or other drain component that can be blocked by leaves or other debris or to entrap standing water. Runoff shall be diverted away from the open front and avoid any possible entrapment of standing water.
- A clear space of 6" to 12" for the sides and back between the bottom frame member and the foundation.

3.1.3 Construction Materials

Construction material shall consist of:

- No glass or Plexiglas panels.
- Wall panels of 16 gauge perforated metal with ¼" holes on 3/8" stagger pattern.
- Stainless steel fasteners sized to meet specified loads. Any exposed fasteners shall be colored to match the finish of the framework components. Self-tapping fasteners or bolts fastened into threads cut into the aluminum framework at connection points shall not be acceptable.
- Coatings or materials that prevent electrolysis or other corrosion between dissimilar materials.
- All aluminum extrusions and components shall be AA6063-T6, minimum 1/8" wall thickness.

3.1.4 Structural Framing

3.1.4.1 Roof

- Modular allowing for other roof components, such as optional lighting to be securely fastened to the shelter in a concealed and tamper-proof manner.
- A perimeter with a minimum 4" high flat fascia suitable for application of logo decals, or location identification.
- Two horizontally channels: one to serve as a rain gutter and the other to allow for optional electrical wiring for lighting and/or conduit for "real-time" transit "information. Rain diverter channel will be covered with perforated screens to avoid debris collection
- Pre-drilled Roof beams with alignment channels for supporting legs to facilitate field installation.
- No snap together corners which can be vandalized.
- Dome or barrel vault roof.

3.1.4.2 Other

- Shelters being surface-mounted with threaded rod and epoxy or approved equal to concrete pads without the need for special footings or other foundations.
- Joints that are neat and clean and edges free of burrs.
- Ability to have welded on a J-hook on top corners of shelter to aid in easy temporary movement of shelter.
- A powder-coat finish with touch-up kit to match the color. An outline of proposed powder coat finish process including sandblast, cleaning, pretreat, top coat and quality check shall be provided.
- Walls supported with adjustable stainless steel assemblies, which anchor to the concrete pad or sidewalk.
- Adjustable plated footings (with flared escutcheons for finished appearance) made of material compatible with the mounting of the corner posts feet, internally telescoping into the bottom of the posts in order to accommodate a minimum 12" variation in pad surface height. Final level shall be maintained by a minimum of two, ¼" stainless steel rivets or fasteners per post. Self-tapping screws shall not be acceptable.
- Mechanisms to be frangible or breakaway when impacted. Acceptable breakaway mechanisms for shelters include hardware that breaks away without slowing the vehicle by more than 15.4 feet per second and that leaves a stub with no substantial remains taller than 4 inches. Breakaway supports should be of an omni-directional design.

3.2 Benches

All benches shall have an expected lifespan of at least 12 years.

- All benches will be ADA-compliant. For standalone benches, bench dimensions shall be as follows:
 - o 20" to 24" in seat depth;
 - o Maximum 28" in depth and 44" in height;
 - o 42" to 74" in width;
 - o Bench seat 17" (preferred) to 19" above the ground or floor;
 - o Back support that extends from a point 2" maximum from above the seat surface to a point 18" above the seat surface (gap between seat and back support).

Benches shall also contain the following features/characteristics:

- Be able to support 250 pounds of force applied at any point on the seat, fastener, mounting device, or supporting structure.
- Surface mounted with stainless steel hardware anchors which shall be tamper resistant, stainless steel.
- Be slip-resistant and designed to shed water.
- Match the style of accompanying amenities.
- Bolt-on anti-vagrant bar(s).

Benches of the same style but scaled to fit each shelter style and that meet all other applicable requirements stated in this document are also of interest. These benches should be same color as shelter.

3.3 Trash Receptacles

RTS desires trash receptacles to match the material and color of surrounding amenities requested. Other trash receptacles features/characteristics include:

- Surface mountable on concrete pad independent of the shelter structure using stainless steel anchors
- A capacity of 30 to 35 gallons,
- Twenty gauge steel that is 100% welded including hinge latch mechanism that can be locked that can be locked
- Hard rubber linear
- Powder coat finish approximately 5ml thick
- Design considerations that ensure explosive or hazardous materials cannot be hidden inside the receptacle
- Dome lid cover capable of reducing the deposit of oversized items and reducing water buildup in the receptacle

If attached to a shelter, the trash receptacle should be capable of attaching to shelter end leg pole and have a 20 gallon capacity and be the same color as the shelter.

3.4 Bicycle Racks

All bicycle racks shall have an inverted U shape and meet the standards set forth in the City of Gainesville Engineering, Design, and Construction Manual (refer to first document referenced in footnotes on page 15).

3.5 Solar Lighting

Bus stop solar lighting should be autonomous, fully self-contained without the need for connection to the local utility power grid (or external wiring) and have a minimum five day battery reserve from full charge with zero solar charge. Battery component shall be industry-approved rechargeable, non-spillable, sealed absorbed glass mat, requiring minimal maintenance with a minimum three-year life span and re-usable or recyclable. Batteries must be capable of providing (3) three years of trouble free charging and discharging and warranted for a (3) three year pro-rated period. It should also include the other following features/characteristics:

- Cast light patterns that concentrate light at the shelter or the stop while minimizing overthrow of glare on to the street, as well as harsh shadows. Cutoff luminaries, low-reflectance surfaces, and low-angle spotlights can be employed to reduce light pollution.
- Minimize off-site lighting and night-sky light pollution through proper lighting direction and lamp shielding.
- Programmable hours of operation with an ADA-compliant on-demand on/off button. When button is used for operation the lighting must remain on for up to 15 minutes per activation.
- Mountable to the bus shelter; must have dedicated pole bracket options. When attached to a bus shelter:

- o Solar illumination is for interior seating area of shelter only.
- o The level of lighting at the shelter pavement should be between 22 and 54 lumens per square meter
- Standard off the shelf products for all components.
- Use bright white, Light-Emitting Diode (LED) with minimum 50,000 hour lifespan
- Fully assembled and installable on an existing or new post in minutes.
- Low profile
- Contain a smart controller which has a self-test feature and data collection capabilities
- Include vandal resistant hardware designed to withstand abuse from potentially damaging individuals.
- Security fasteners at all exposed points
- Modular design to allow for independent replacement of solar collector, light bar, light fixtures/bulbs, batteries and lighting control module.
- Powder coated; finish is to be warranted for a minimum of 5 years.
- Five year minimum warranty on all major components, excluding batteries.

Other optional lighting features include a bus stop pole with a light on top for ambient lighting at the stop along with a lighted schedule holder. The schedule holder light should last at least 2 minutes when activated to allow someone to read the schedule.

3.6 Kiosk Panels

RTS uses kiosks to display system information. Kiosks should have smooth, rounded corners, fit paper 11" x 17", and have a powder coat finish with UV protected, tamper and vandal-resistant polycarbonate. They should also be mountable to a standard u-channel pole, wall, or shelter.

4. Federal Transit Administration (FTA) Requirements

STATEMENT OF FINANCIAL ASSISTANCE. This solicitation will be funded in whole or in part by the U.S. Department of Transportation, Federal Transit Administration.

The following requirements are applicable for this solicitation:

4.1 NO GOVERNMENT OBLIGATION TO THIRD PARTIES

The Recipient and Contractor acknowledge and agree that, notwithstanding any concurrence by the Federal Government in or approval of the solicitation or award of the underlying Contract, absent the express written consent by the Federal Government, the Federal Government is not a party to this Contract and shall not be subject to any obligations or liabilities to the Recipient, Contractor or any other party (whether or not a party to that contract) pertaining to any matter resulting from the underlying Contract. The Contractor agrees to include the above clause in each subcontract financed in whole or in part with Federal assistance provided by the FTA. It is further agreed that the clause shall not be modified, except to identify the subcontractor who will be subject to its provisions.

4.2 PROGRAM FRAUD AND FALSE OR FRAUDULENT STATEMENTS AND RELATED ACTS

The Contractor acknowledges that the provisions of the Program Fraud Civil Remedies Act of 1986, as amended, 31 U.S.C. § 3801 et seq. and U.S. DOT regulations, "Program Fraud Civil Remedies," 49 C.F.R. Part 31, apply to its actions pertaining to this Project. Upon execution of the underlying contract, the Contractor certifies or affirms the truthfulness and accuracy of any statement it has made, it makes, it may make, or causes to be made, pertaining to the underlying contract or the FTA assisted project for which this contract work is being performed. In addition to other penalties that may be applicable, the Contractor further acknowledges that if it makes, or causes to be made, a false, fictitious, or fraudulent claim, statement, submission, or certification, the Federal Government reserves the right to impose the penalties of the Program Fraud Civil Remedies Act of 1986 on the Contractor to the extent the Federal Government deems appropriate.

The Contractor also acknowledges that if it makes, or causes to be made, a false, fictitious, or fraudulent claim, statement, submission, or certification to the Federal Government under a contract connected with a project that is financed in whole or in part with Federal assistance originally awarded by FTA under the authority of 49 U.S.C. § 5307, the Government reserves the right to impose the penalties of 18 U.S.C. § 1001 and 49 U.S.C. § 5307(n)(1) on the Contractor, to the extent the Federal Government deems appropriate.

The Contractor agrees to include the above two clauses in each subcontract financed in whole or in part with Federal assistance provided by FTA. It is further agreed that the clauses shall not be modified, except to identify the subcontractor who will be subject to the provisions.

4.3 ACCESS TO RECORDS AND REPORTS

- a. **Record Retention.** The Contractor will retain, and will require its subcontractors of all tiers to retain, complete and readily accessible records related in whole or in part to the contract, including, but not limited to, data, documents, reports, statistics, sub-agreements, leases, subcontracts, arrangements, other third party agreements of any type, and supporting materials related to those records.
- b. **Retention Period.** The Contractor agrees to comply with the record retention requirements in accordance with 2 C.F.R. § 200.333. The Contractor shall maintain all books, records, accounts and reports required under this Contract for a period of at not less than three (3) years after the date of termination or expiration of this Contract, except in the event of litigation or settlement of claims arising from the performance of this Contract, in which case records shall be maintained until the disposition of all such litigation, appeals, claims or exceptions related thereto.
- c. **Access to Records.** The Contractor agrees to provide sufficient access to FTA and its contractors to inspect and audit records and information related to performance of this contract as reasonably may be required.
- d. **Access to the Sites of Performance.** The Contractor agrees to permit FTA and its contractors access to the sites of performance under this contract as reasonably may be required.

4.4 FEDERAL CHANGES

Contractor shall at all times comply with all applicable FTA regulations, policies, procedures and directives, including without limitation those listed directly or by reference in the Master Agreement between Purchaser and FTA, as they may be amended or promulgated from time to time during the term of this contract. Contractor's failure to so comply shall constitute a material breach of this contract.

4.5 CIVIL RIGHT LAWS AND REGULATIONS

The City of Gainesville is an Equal Opportunity Employer. As such, the City of Gainesville agrees to comply with all applicable Federal civil rights laws and implementing regulations. Apart from inconsistent requirements imposed by Federal laws or regulations, the City of Gainesville agrees to comply with the requirements of 49 U.S.C. § 5323(h) (3) by not using any Federal assistance awarded by FTA to support procurements using exclusionary or discriminatory specifications.

Under this Agreement, the Contractor shall at all times comply with the following requirements and shall include these requirements in each subcontract entered into as part thereof.

- a. **Nondiscrimination.** In accordance with Federal transit law at 49 U.S.C. § 5332, the Contractor agrees that it will not discriminate against any employee or applicant for employment because of race, color, religion, national origin, sex, disability, or age. In addition, the Contractor agrees to comply with applicable Federal implementing regulations and other implementing requirements FTA may issue.
- b. **Race, Color, Religion, National Origin, Sex.** In accordance with Title VII of the Civil Rights Act, as amended, 42 U.S.C. § 2000e et seq., and Federal transit laws at 49 U.S.C. § 5332, the Contractor agrees to comply with all applicable equal employment opportunity requirements of U.S. Department of Labor (U.S. DOL) regulations, "Office of Federal Contract Compliance Programs, Equal Employment Opportunity, Department of Labor," 41 C.F.R. chapter 60, and Executive Order No. 11246, "Equal Employment Opportunity in Federal Employment," September 24, 1965, 42 U.S.C. § 2000e note, as amended by any later Executive Order that amends or supersedes it, referenced in 42 U.S.C. § 2000e note. The Contractor agrees to take affirmative action to ensure that applicants are employed, and that employees are treated during employment, without regard to their race, color, religion, national origin, or sex (including sexual orientation and gender identity). Such action shall include, but not be limited to, the following: employment, promotion, demotion or transfer, recruitment or recruitment advertising, layoff or termination; rates of pay or other forms of compensation; and selection for training, including apprenticeship. In addition, the Contractor agrees to comply with any implementing requirements FTA may issue.
- c. **Age.** In accordance with the Age Discrimination in Employment Act, 29 U.S.C. §§ 621-634, U.S. Equal Employment Opportunity Commission (U.S. EEOC) regulations, "Age Discrimination in Employment Act," 29 C.F.R. part 1625, the Age Discrimination Act of 1975, as amended, 42 U.S.C. § 6101 et seq., U.S. Health and Human Services regulations, "Nondiscrimination on the Basis of Age in Programs or Activities Receiving

Federal Financial Assistance,” 45 C.F.R. part 90, and Federal transit law at 49 U.S.C. § 5332, the Contractor agrees to refrain from discrimination against present and prospective employees for reason of age. In addition, the Contractor agrees to comply with any implementing requirements FTA may issue.

- d. **Disabilities.** In accordance with section 504 of the Rehabilitation Act of 1973, as amended, 29 U.S.C. § 794, the Americans with Disabilities Act of 1990, as amended, 42 U.S.C. § 12101 et seq., the Architectural Barriers Act of 1968, as amended, 42 U.S.C. § 4151 et seq., and Federal transit law at 49 U.S.C. § 5332, the Contractor agrees that it will not discriminate against individuals on the basis of disability. In addition, the Contractor agrees to comply with any implementing requirements FTA may issue.

4.6 DISADVANTAGED BUSINESS ENTERPRISE (DBE)

The contractor, subrecipient or subcontractor shall not discriminate on the basis of race, color, national origin, or sex in the performance of this contract. The contractor shall carry out applicable requirements of 49 C.F.R. part 26 in the award and administration of DOT-assisted contracts. Failure by the contractor to carry out these requirements is a material breach of this contract, which may result in the termination of this contract or such other remedy as the recipient deems appropriate, which may include, but is not limited to:

- a. Withholding monthly progress payments;
- b. Assessing sanctions;
- c. Liquidated damages; and/or
- d. Disqualifying the contractor from future bidding as non-responsible. 49 C.F.R. § 26.13(b).

The contractor is required to pay its subcontractors performing work related to this contract for satisfactory performance of that work no later than 30 days after the contractor’s receipt of payment for that work from the City of Gainesville, Florida. In addition, the contractor is required to return any retainage payments to those subcontractors within 30 days after the subcontractor’s work related to this contract is satisfactorily completed.

The national goal for participation of Disadvantaged Business Enterprises (DBE) is 10%. The agency’s overall goal for DBE participation for the period October 1, 2013 through September 30, 2017 is 1.5%.

4.7 ENERGY CONSERVATION

The contractor agrees to comply with mandatory standards and policies relating to energy efficiency which are contained in the state energy conservation plan issued in compliance with the Energy Policy and Conservation Act.

4.8 AMERICANS WITH DISABILITIES ACT

- a. New Buses and Construction: All design and construction must meet all federal regulations of 49 CFR Part 37 and Part 38.
- b. Used Buses: Must meet all federal regulations of 49 CFR Part 38.
- c. Modification of Facilities: Must meet all federal regulations of Appendix A to 49 CFR Part 37, the ADA Accessibility Guideline (ADAAG).

4.9 PRIVACY ACTS

- a. The Contractor agrees to comply with, and assures the compliance of its employees with, the information restrictions and other applicable requirements of the Privacy Act of 1974, 5 U.S.C. § 552a. Among other things, the Contractor agrees to obtain the express consent of the Federal Government before the Contractor or its employees operate a system of records on behalf of the Federal Government. The Contractor understands that the requirements of the Privacy Act, including the civil and criminal penalties for violation of that Act, apply to those individuals involved, and that failure to comply with the terms of the Privacy Act may result in termination of the underlying contract.
- b. The Contractor also agrees to include these requirements in each subcontract to administer any system of records on behalf of the Federal Government financed in whole or in part with Federal assistance provided by FTA.

4.10 SAFE OPERATION OF MOTOR VEHICLES

Seat Belt Use

The Contractor is encouraged to adopt and promote on-the-job seat belt use policies and programs for its employees and other personnel that operate company-owned vehicles, company-rented vehicles, or personally operated vehicles. The terms “company-owned” and “company-leased” refer to vehicles owned or leased either by the Contractor or City of Gainesville.

Distracted Driving

The Contractor agrees to adopt and enforce workplace safety policies to decrease crashes caused by distracted drivers, including policies to ban text messaging while using an electronic device supplied by an employer, and driving a vehicle the driver owns or rents, a vehicle Contractor owns, leases, or rents, or a privately-owned vehicle when on official business in connection with the work performed under this agreement.

4.11 INCORPORATION OF FEDERAL TRANSIT ADMINISTRATION (FTA) TERMS

The preceding provisions include, in part, certain Standard Terms and Conditions required by DOT, whether or not expressly set forth in the preceding contract provisions. All contractual provisions required by DOT, as set forth in FTA Circular 4220.1F, are hereby incorporated by reference. Anything to the contrary herein notwithstanding, all FTA mandated terms shall be deemed to control in the event of a conflict with other provisions contained in this Agreement. The Contractor shall not perform any act, fail to perform any act, or refuse to comply with any City of Gainesville requests which would cause City of Gainesville to be in violation of the FTA terms and conditions.

The following conditional requirements may apply based upon value and/or item/service:

4.12 TERMINATION - *If this solicitation or contract is valued in excess of \$10,000:*

Termination for Convenience (General Provision)

The City of Gainesville may terminate this contract, in whole or in part, at any time by written notice to the Contractor when it is in the City of Gainesville’s best interest. The Contractor shall be paid its costs, including contract close-out costs, and profit on work performed up to the time of termination. The Contractor shall promptly submit its termination claim to City of Gainesville to be paid the Contractor. If the Contractor has any property in its possession belonging to City of Gainesville, the Contractor will account for the same, and dispose of it in the manner City of Gainesville directs.

Termination for Default [Breach or Cause] (General Provision)

If the Contractor does not deliver supplies in accordance with the contract delivery schedule, or if the contract is for services, the Contractor fails to perform in the manner called for in the contract, or if the Contractor fails to comply with any other provisions of the contract, the City of Gainesville may terminate this contract for default. Termination shall be effected by serving a Notice of Termination on the Contractor setting forth the manner in which the Contractor is in default. The Contractor will be paid only the contract price for supplies delivered and accepted, or services performed in accordance with the manner of performance set forth in the contract.

If it is later determined by the City of Gainesville that the Contractor had an excusable reason for not performing, such as a strike, fire, or flood, events which are not the fault of or are beyond the control of the Contractor, the City of Gainesville, after setting up a new delivery of performance schedule, may allow the Contractor to continue work, or treat the termination as a Termination for Convenience.

Opportunity to Cure (General Provision)

The City of Gainesville, in its sole discretion may, in the case of a termination for breach or default, allow the Contractor [an appropriately short period of time] in which to cure the defect. In such case, the Notice of Termination will state the time period in which cure is permitted and other appropriate conditions.

If Contractor fails to remedy to City of Gainesville's satisfaction the breach or default of any of the terms, covenants, or conditions of this Contract within [10 days] after receipt by Contractor of written notice from City of Gainesville setting forth the nature of said breach or default, City of Gainesville shall have the right to terminate the contract without any further obligation to Contractor. Any such termination for default shall not in any way operate to preclude City of Gainesville from also pursuing all available remedies against Contractor and its sureties for said breach or default.

Waiver of Remedies for any Breach

In the event that City of Gainesville elects to waive its remedies for any breach by Contractor of any covenant, term or condition of this contract, such waiver by City of Gainesville shall not limit City of Gainesville's remedies for any succeeding breach of that or of any other covenant, term, or condition of this contract.

- 4.13 **RECYCLED PRODUCTS** - *If this solicitation or contract is for items designated in Subpart B, 40 CFR part 247 by the EPA, and the City of Gainesville procures \$10,000 or more of one of these items during the fiscal year or has procured \$10,000 or more of such items in the previous fiscal year using federal funds:*

Recovered Materials

The Contractor agrees to provide a preference for those products and services that conserve natural resources, protect the environment, and are energy efficient by complying with and facilitating compliance with Section 6002 of the Resource Conservation and Recovery Act, as amended, 42 U.S.C. § 6962, and U.S. Environmental Protection Agency (U.S. EPA), "Comprehensive Procurement Guideline for Products Containing Recovered Materials," 40 C.F.R. part 247.

- 4.14 **GOVERNMENT WIDE DEBARMENT AND SUSPENSION** - *If this solicitation or contract is valued at \$25,000 or more:*

Debarment, Suspension, Ineligibility and Voluntary Exclusion

The Contractor shall comply and facilitate compliance with U.S. DOT regulations, "Nonprocurement Suspension and Debarment," 2 C.F.R. part 1200, which adopts and supplements the U.S. Office of Management and Budget (U.S. OMB) "Guidelines to Agencies on Governmentwide Debarment and Suspension (Nonprocurement)," 2 C.F.R. part 180. These provisions apply to each contract at any tier of \$25,000 or more, and to each contract at any tier for a federally required audit (irrespective of the contract amount), and to each contract at any tier that must be approved by an FTA official irrespective of the contract amount. As such, the Contractor shall verify that its principals, affiliates, and subcontractors are eligible to participate in this federally funded contract and are not presently declared by any Federal department or City of Gainesville to be:

- a. Debarred from participation in any federally assisted Award;
- b. Suspended from participation in any federally assisted Award;
- c. Proposed for debarment from participation in any federally assisted Award;
- d. Declared ineligible to participate in any federally assisted Award;
- e. Voluntarily excluded from participation in any federally assisted Award; or
- f. Disqualified from participation in any federally assisted Award.

By signing and submitting its bid or proposal, the bidder or proposer certifies as follows:

The certification in this clause is a material representation of fact relied upon by the City of Gainesville. If it is later determined by the City of Gainesville that the bidder or proposer knowingly rendered an erroneous certification, in addition to remedies available to the City of Gainesville, the Federal Government may pursue available remedies, including but not limited to suspension and/or debarment. The bidder or proposer agrees to comply with the requirements of 2 C.F.R. part 180, subpart C, as supplemented by 2 C.F.R. part 1200, while this offer is valid and throughout the period of any contract that may arise from this offer. The bidder or proposer further agrees to include a provision requiring such compliance in its lower tier covered transactions.

- 4.15 **BUY AMERICA** - *If this solicitation or contract exceeds \$150,000 (includes rolling stock and construction):*

The contractor agrees to comply with 49 U.S.C. 5323(j) and 49 C.F.R. part 661, which provide that Federal funds may not be obligated unless all steel, iron, and manufactured products used in FTA funded projects are produced in the United States, unless a waiver has been granted by FTA or the product is subject to a general waiver. General waivers are

listed in 49 C.F.R. § 661.7. Separate requirements for rolling stock are set out at 49 U.S.C. 5323(j)(2)(C) and 49 C.F.R. § 661.11.

4.16 VIOLATION AND BREACH OF CONTRACT - *If this solicitation or contract exceeds \$150,000:*

Rights and Remedies of the City of Gainesville

The City of Gainesville shall have the following rights in the event that the City of Gainesville deems the Contractor guilty of a breach of any term under the Contract.

- a. The right to take over and complete the work or any part thereof as City of Gainesville for and at the expense of the Contractor, either directly or through other contractors;
- b. The right to cancel this Contract as to any or all of the work yet to be performed;
- c. The right to specific performance, an injunction or any other appropriate equitable remedy; and
- d. The right to money damages.

For purposes of this Contract, breach shall include [AGENCY to define].

Rights and Remedies of Contractor

Inasmuch as the Contractor can be adequately compensated by money damages for any breach of this Contract, which may be committed by the City of Gainesville, the Contractor expressly agrees that no default, act or omission of the City of Gainesville shall constitute a material breach of this Contract, entitling Contractor to cancel or rescind the Contract (unless the City of Gainesville directs Contractor to do so) or to suspend or abandon performance.

Remedies

Substantial failure of the Contractor to complete the Project in accordance with the terms of this Agreement will be a default of this Agreement. In the event of a default, the City of Gainesville will have all remedies in law and equity, including the right to specific performance, without further assistance, and the rights to termination or suspension as provided herein. The Contractor recognizes that in the event of a breach of this Agreement by the Contractor before the City of Gainesville takes action contemplated herein, the City of Gainesville will provide the Contractor with sixty (60) days written notice that the City of Gainesville considers that such a breach has occurred and will provide the Contractor a reasonable period of time to respond and to take necessary corrective action.

Disputes

- **Example 1:** Disputes arising in the performance of this Contract that are not resolved by agreement of the parties shall be decided in writing by the authorized representative of City of Gainesville's [title of employee]. This decision shall be final and conclusive unless within [10] days from the date of receipt of its copy, the Contractor mails or otherwise furnishes a written appeal to the [title of employee]. In connection with any such appeal, the Contractor shall be afforded an opportunity to be heard and to offer evidence in support of its position. The decision of the [title of employee] shall be binding upon the Contractor and the Contractor shall abide by the decision.
- **Example 2:** The City of Gainesville and the Contractor intend to resolve all disputes under this Agreement to the best of their abilities in an informal manner. To accomplish this end, the parties will use an Alternative Dispute Resolution process to resolve disputes in a manner designed to avoid litigation. In general, the parties contemplate that the Alternative Dispute Resolution process will include, at a minimum, an attempt to resolve disputes through communications between their staffs, and, if resolution is not reached at that level, a procedure for review and action on such disputes by appropriate management level officials within the City of Gainesville and the Contractor's organization.

In the event that a resolution of the dispute is not mutually agreed upon, the parties can agree to mediate the dispute or proceed with litigation. Notwithstanding any provision of this section, or any other provision of this Contract, it is expressly agreed and understood that any court proceeding arising out of a dispute under the Contract

shall be heard by a Court de novo and the court shall not be limited in such proceeding to the issue of whether the Authority acted in an arbitrary, capricious or grossly erroneous manner.

Pending final settlement of any dispute, the parties shall proceed diligently with the performance of the Contract, and in accordance with the City of Gainesville's direction or decisions made thereof.

Performance during Dispute

Unless otherwise directed by City of Gainesville, Contractor shall continue performance under this Contract while matters in dispute are being resolved.

Claims for Damages

Should either party to the Contract suffer injury or damage to person or property because of any act or omission of the party or of any of its employees, agents or others for whose acts it is legally liable, a claim for damages therefor shall be made in writing to such other party within a reasonable time after the first observance of such injury or damage.

Remedies

Unless this Contract provides otherwise, all claims, counterclaims, disputes and other matters in question between the City of Gainesville and the Contractor arising out of or relating to this agreement or its breach will be decided by arbitration if the parties mutually agree, or in a court of competent jurisdiction within the State in which the City of Gainesville is located.

Rights and Remedies

The duties and obligations imposed by the Contract documents and the rights and remedies available thereunder shall be in addition to and not a limitation of any duties, obligations, rights and remedies otherwise imposed or available by law. No action or failure to act by the City of Gainesville or Contractor shall constitute a waiver of any right or duty afforded any of them under the Contract, nor shall any such action or failure to act constitute an approval of or acquiescence in any breach thereunder, except as may be specifically agreed in writing.

4.17 LOBBYING RESTRICTIONS - *If this solicitation or contract is for \$100,000 or more:*

Byrd Anti-Lobbying Amendment, 31 U.S.C. 1352(b)(5), as amended by the Lobbying Disclosure Act of 1995, P.L. 104-65 [to be codified at 2 U.S.C. § 1601, et seq.] - Contractors who apply or bid for an award of \$100,000 or more shall file the certification required by 49 CFR part 20, "New Restrictions on Lobbying." Each tier certifies to the tier above that it will not and has not used Federal appropriated funds to pay any person or organization for influencing or attempting to influence an officer or employee of any City of Gainesville, a member of Congress, officer or employee of Congress, or an employee of a member of Congress in connection with obtaining any Federal contract, grant or any other award covered by 31 U.S.C. 1352(b)(5). Each tier shall also disclose the name of any registrant under the Lobbying Disclosure Act of 1995 who has made lobbying contacts on its behalf with non-Federal funds with respect to that Federal contract, grant or award covered by 31 U.S.C. 1352(b)(5). Such disclosures are forwarded from tier to tier up to the recipient.

4.18 CLEAN AIR ACT AND FEDERAL WATER POLLUTION CONTROL ACT - *If this solicitation or contract exceeds \$150,000 in any year:*

The Contractor agrees:

- a. It will not use any violating facilities;
- b. It will report the use of facilities placed on or likely to be placed on the U.S. EPA "List of Violating Facilities;"
- c. It will report violations of use of prohibited facilities to FTA; and
- d. It will comply with the inspection and other requirements of the Clean Air Act, as amended, (42 U.S.C. §§ 7401 - 7671q); and the Federal Water Pollution Control Act as amended, (33 U.S.C. §§ 1251-1387).

BUY AMERICA CERTIFICATION
(Sign either compliance or non-compliance, not both)

The [bidder or offeror] must submit to City of Gainesville the appropriate Buy America certification below with its [bid or offer]. Bids or offers that are not accompanied by a completed Buy America certification will be rejected as nonresponsive.

In accordance with 49 C.F.R. § 661.6, for the procurement of steel, iron or manufactured products, use the certifications below.

Certificate of Compliance with Buy America Requirements

The bidder or offeror hereby certifies that it will comply with the requirements of 49 U.S.C. 5323(j)(1) and the applicable regulations in 49 C.F.R. Part 661.

Date March 31, 2017

Signature 

Company Prison Rehabilitative Industries & Diversified Enterprises, Inc. DBA: PRIDE Enterprises

Name Joseph G. Keen

Title Sales Support Center Manager

Certificate of Non-Compliance with Buy America Requirements

The bidder or offeror hereby certifies that it cannot comply with the requirements of 49 U.S.C. 5323(j), but it may qualify for an exception to the requirement pursuant to 49 U.S.C. 5323(j)(2), as amended, and the application regulations in 49 C.F.R. § 661.7.

Date _____

Signature _____

Company _____

Name _____

Title _____

TO BE RESPONSIVE THIS FORM MUST BE COMPLETED, SIGNED AND RETURNED WITH BID RESPONSE TO BE CONSIDERED FOR AWARD.

CERTIFICATION REGARDING LOBBYING

The undersigned certifies, to the best of his or her knowledge and belief, that:

1. No Federal appropriated funds have been paid or will be paid, by or on behalf of the undersigned, to any person for influencing or attempting to influence an officer or employee of an agency, a Member of Congress, an officer or employee of Congress, or an employee of a Member of Congress in connection with the awarding of any Federal contract, the making of any Federal grant, the making of any Federal loan, the entering into of any cooperative agreement, and the extension, continuation, renewal, amendment, or modification of any Federal contract, grant, loan, or cooperative agreement.
2. If any funds other than Federal appropriated funds have been paid or will be paid to any person for influencing or attempting to influence an officer or employee of any agency, a Member of Congress, an officer or employee of Congress, or an employee of a Member of Congress in connection with this Federal contract, grant, loan, or cooperative agreement, the undersigned shall complete and submit Standard Form-LLL, "Disclosure Form to Report Lobbying," in accordance with its instructions
3. The undersigned shall require that the language of this certification be included in the award documents for all subawards at all tiers (including subcontracts, subgrants, and contracts under grants, loans, and cooperative agreements) and that all subrecipients shall certify and disclose accordingly.

This certification is a material representation of fact upon which reliance was placed when this transaction was made or entered into. Submission of this certification is a prerequisite for making or entering into this transaction imposed by 1352, title 31, U.S. Code. Any person who fails to file the required certification shall be subject to a civil penalty of not less than \$10,000 and not more than \$100,000 for each such failure.



Signature of Contractor's Authorized Official

Joseph G. Keen, Sales Support Center Manager

Name and Title of Contractor's Authorized Official

March 31, 2017 Date

DISCLOSURE OF LOBBYING ACTIVITIES
 Complete this form to disclose lobbying activities pursuant to 31 U.S.C. 1352
 (See reverse for public burden disclosure.)

Approved by OMB
 0348-0046

(To be submitted by bidder, if applicable, refer to instructions on the next page)

1. Type of Federal Action: <input type="checkbox"/> a. contract <input type="checkbox"/> b. grant <input type="checkbox"/> c. cooperative agreement <input type="checkbox"/> d. loan <input type="checkbox"/> e. loan guarantee <input type="checkbox"/> f. loan insurance	2. Status of Federal Action: <input type="checkbox"/> a. bid/offer/application <input type="checkbox"/> b. initial award <input type="checkbox"/> c. post-award	3. Report Type: <input type="checkbox"/> a. initial filing <input type="checkbox"/> b. material change For Material Change Only: Year _____ quarter _____ date of last report _____
4. Name and Address of Reporting Entity: <input type="checkbox"/> Prime <input type="checkbox"/> Subawardee Tier _____, if known : Congressional District, if known: 4c	5. If Reporting Entity in No. 4 is a Subawardee, Enter Name and Address of Prime: Congressional District, if known:	
6. Federal Department/Agency:	7. Federal Program Name/Description: CFDA Number, if applicable: _____	
8. Federal Action Number, if known :	9. Award Amount, if known : \$ _____	
10. a. Name and Address of Lobbying Registrant (if individual, last name, first name, MI):	b. Individuals Performing Services (including address if different from No. 10a) (last name, first name, MI):	
11. Information requested through this form is authorized by title 31 U.S.C. section 1352. This disclosure of lobbying activities is a material representation of fact upon which reliance was placed by the tier above when this transaction was made or entered into. This disclosure is required pursuant to 31 U.S.C. 1352. This information will be available for public inspection. Any person who fails to file the required disclosure shall be subject to a civil penalty of not less than \$10,000 and not more than \$100,000 for each such failure.	Signature: _____ Print Name: _____ Title: _____ Telephone No.: _____ Date: _____	
Federal Use Only:		Authorized for Local Reproduction Standard Form LLL (Rev. 7-97)

INSTRUCTIONS FOR COMPLETION OF SF-LLL, DISCLOSURE OF LOBBYING ACTIVITIES

This disclosure form shall be completed by the reporting entity, whether subawardee or prime Federal recipient, at the initiation or receipt of a covered Federal action, or a material change to a previous filing, pursuant to title 31 U.S.C. section 1352. The filing of a form is required for each payment or agreement to make payment to any lobbying entity for influencing or attempting to influence an officer or employee of any agency, a Member of Congress, an officer or employee of Congress, or an employee of a Member of Congress in connection with a covered Federal action. Complete all items that apply for both the initial filing and material change report. Refer to the implementing guidance published by the Office of Management and Budget for additional information.

1. Identify the type of covered Federal action for which lobbying activity is and/or has been secured to influence the outcome of a covered Federal action.
2. Identify the status of the covered Federal action.
3. Identify the appropriate classification of this report. If this is a follow-up report caused by a material change to the information previously reported, enter the year and quarter in which the change occurred. Enter the date of the last previously submitted report by this reporting entity for this covered Federal action.
4. Enter the full name, address, city, State and zip code of the reporting entity. Include Congressional District, if known. Check the appropriate classification of the reporting entity that designates if it is, or expects to be, a prime or subaward recipient. Identify the tier of the subawardee, e.g., the first subawardee of the prime is the 1st tier. Subawards include but are not limited to subcontracts, subgrants and contract awards under grants.
5. If the organization filing the report in item 4 checks "Subawardee," then enter the full name, address, city, State and zip code of the prime Federal recipient. Include Congressional District, if known.
6. Enter the name of the Federal agency making the award or loan commitment. Include at least one organizational level below agency name, if known. For example, Department of Transportation, United States Coast Guard.
7. Enter the Federal program name or description for the covered Federal action (item 1). If known, enter the full Catalog of Federal Domestic Assistance (CFDA) number for grants, cooperative agreements, loans, and loan commitments.
8. Enter the most appropriate Federal identifying number available for the Federal action identified in item 1 (e.g., Request for Proposal (RFP) number; Invitation for Bid (IFB) number; grant announcement number; the contract, grant, or loan award number; the application/proposal control number assigned by the Federal agency). Include prefixes, e.g., "RFP-DE-90-001."
9. For a covered Federal action where there has been an award or loan commitment by the Federal agency, enter the Federal amount of the award/loan commitment for the prime entity identified in item 4 or 5.
10. (a) Enter the full name, address, city, State and zip code of the lobbying registrant under the Lobbying Disclosure Act of 1995 engaged by the reporting entity identified in item 4 to influence the covered Federal action.
(b) Enter the full names of the individual(s) performing services, and include full address if different from 10 (a). Enter Last Name, First Name, and Middle Initial (MI).
11. The certifying official shall sign and date the form; print his/her name, title, and telephone number.

According to the Paperwork Reduction Act, as amended, no persons are required to respond to a collection of information unless it displays a valid OMB Control Number. The valid OMB control number for this information collection is OMB No. 0348-0046. Public reporting burden for this collection of information is estimated to average 10 minutes per response, including time for reviewing instructions, searching existing data sources, gathering and maintaining the data needed, and completing and reviewing the collection of information. Send comments regarding the burden estimate or any other aspect of this collection of information, including suggestions for reducing this burden, to the Office of Management and Budget, Paperwork Reduction Project (0348-0046), Washington, DC 20503.

CONTRACTOR RESPONSIBILITY CERTIFICATION

The Bidder is required to certify compliance with the following contractor responsibility standards by checking appropriate boxes. For purposes hereof, all relevant time periods are calculated from the date this Certification is executed.

	YES	NO
1. Has the firm been suspended and/or debarred by any federal, state or local government agency or authority in the past three years?	<input type="checkbox"/>	<input checked="" type="checkbox"/>
2. Has any officer, director, or principal of the firm been convicted of a felony relating to your business industry?	<input type="checkbox"/>	<input checked="" type="checkbox"/>
3. Has the firm defaulted on any project in the past three (3) years?	<input type="checkbox"/>	<input checked="" type="checkbox"/>
4. Has the firm had any type of business, contracting or trade license revoked or suspended for cause by any government agency or authority in the past three (3) years?	<input type="checkbox"/>	<input checked="" type="checkbox"/>
5. Has the firm been found in violation of any other law relating to its business, including, but not limited to antitrust laws, licensing laws, tax laws, wage or hour laws, environmental or safety laws, by a final unappealed decision of a court or government agency in the past three (3) years, where the result of such adjudicated violation was a payment of a fine, damages or penalty in excess of \$1,000?	<input type="checkbox"/>	<input checked="" type="checkbox"/>
6. Has the firm been the subject of voluntary or involuntary bankruptcy proceedings at any time in the past three (3) years?	<input type="checkbox"/>	<input checked="" type="checkbox"/>
7. Has the firm successfully provided similar products or performed similar services in the past three (3) years with a satisfactory record of timely deliveries or on-time performance?	<input checked="" type="checkbox"/>	<input type="checkbox"/>
8. Does the firm currently possess all applicable business, contractor and/or trade licenses or other appropriate licenses or certifications required by applicable state or local laws to engage in the sale of products or services?	<input checked="" type="checkbox"/>	<input type="checkbox"/>
9. Does the firm have all the necessary experience, technical qualifications and resources, including but not limited to equipment, facilities, personnel and financial resources, to successfully provide the referenced product(s) or perform the referenced service(s), or will obtain same through the use of qualified, responsible subcontractors?	<input checked="" type="checkbox"/>	<input type="checkbox"/>
10. Does the firm meet all insurance requirements per applicable law or bid specifications including general liability insurance, workers' compensation insurance, and automobile liability insurance?	<input checked="" type="checkbox"/>	<input type="checkbox"/>
11. Firm acknowledges that it must provide appropriate documentation to support this Contractor Responsibility Certification if so requested by the City of Gainesville. The firm also understands that the City of Gainesville may request additional information or documents to evaluate the responsibility of firm. Firm agrees to provide such additional information or supporting documentation for this Certification.	<input checked="" type="checkbox"/>	<input type="checkbox"/>

Under the penalty of perjury, the Bidder's authorized representative hereby certifies that all information included in the Contractor Responsibility Certification or otherwise submitted for purposes of determining the Bidder's status as a responsible contractor is true, complete and accurate and that he/she has knowledge and authority to verify the information in this certification or otherwise submitted on behalf of the Bidder by his or her signature below.

Bidder Name: Prison Rehabilitative Industries & Diversified Enterprises, Inc. DBA: PRIDE Enterprises

Name/Title of person completing this form: Joseph G. Keen, Sales Support Center Manager

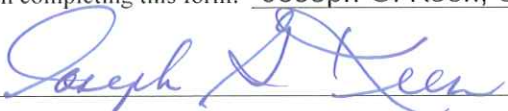
Signature: 

Date: March 31, 2017

**REVISED
BID FORM**

TO: **City of Gainesville, Florida
Purchasing, Station 32
200 East University Avenue
Gainesville, Florida 32601**

PROJECT: **Bus Stop Amenities**

BID#: **RTSX-180002-DS**

BID DUE DATE: **April 5, 2017 at 3:00 p.m. local time**

CITY'S REPRESENTATIVE (to be contacted for additional information on this proposal):

Name: **Daphne Sesco, Senior Buyer** Telephone Number: **352-334-5021**
Fax Number: **352-334-3163**
Email address: **sescoda@cityofgainesville.org**

Bidder Legal Name: Prison Rehabilitative Industries & Diversified Enterprises, Inc.

Bidder Alias/DBA: PRIDE Enterprises

Bidder's Address: 223 Morrison Road, Brandon, FL 33511

BIDDER'S REPRESENTATIVE (to be contacted for additional information on this proposal):

Name: Jason Brown Telephone Number: 813-890-6582

Date: March 31, 2017 Fax Number: 727-570-3449

Email Address: bids@pride-enterprises.org

BIDDER'S DECLARATION AND UNDERSTANDING

The undersigned, hereinafter called the Bidder, declares that the only person or parties interested in this Bid are those named herein, that this Bid is, in all respects, fair and without fraud, that it is made without collusion with any official of the City, and that the Bid is made without any connection or collusion with any person submitting another Bid on this contract.

The Bidder further declares that no City Commissioner, other City officer, or City employee directly or indirectly owns more than five percent of the total assets or capital stock of the bidding entity, nor will directly or indirectly benefit by more than five percent from the profits or emoluments of this contract. (For purposes of this paragraph, indirect ownership or benefit does not include ownership or benefit by a spouse or minor child.)

The Bidder further declares that it has carefully examined the Specifications and that this Bid is made according to the provisions and under the terms of the Specifications, which Specifications are hereby made a part of this Bid.

ADDENDA

The Bidder hereby acknowledges receipt of Addenda No.'s 1, 2, _____, to these Specifications.

TAXES

The Bidder agrees that any applicable Federal, State and Local sales and use taxes, which are to be paid by City of Gainesville, are included in the stated bid prices. Since often the City of Gainesville is exempt from taxes for equipment, materials and services, it is the responsibility of the Contractor to determine whether sales taxes are applicable. The Contractor is liable for any applicable taxes which are not included in the stated bid prices.

BID PRICES

The undersigned hereby proposes and agrees, if this bid is accepted, to provide the items and/or service in accordance with the specifications at the prices stated in the Schedule of Items which follows.

The line item unit price(s) of each amenity listed must include all costs that the bidder intends to recover, including freight. It is assumed that the unit price on large orders may decrease due to bulk freight rates and these savings will be passed to the City of Gainesville. All pricing to be firm for the entirety of contract as no price escalations/adjustments will be made.

	Warranty (Years)	Item	Unit Measure	Estimated Annual Minimum	Estimated Annual Maximum	Unit Price (1-5 pieces)	Unit Price (6-10 pieces)
1	N/A	Kiosk (single-sided)	Each	1	10	\$ No Bid	\$ No Bid
2	N/A	Bus Stop Pole with Lighting and Lighted Schedule Holder	Each	1	10	\$ No Bid	\$ No Bid
3	N/A	Mountable Bus Shelter Lighting	Each	1	10	\$ No Bid	\$ No Bid
4	5 years on Material, 1 year on paint	Bicycle Rack	Each	1	10	\$ 150.00	\$ 150.00
5	5 years on Material, 1 year on paint	Trash Receptacles (with liner) - Free Standing (Non-Solar Powered)	Each	1	10	\$ 535.00	\$ 535.00
6	N/A	Trash Receptacles (with liner) - Mounted Hanging	Each	1	10	\$ No Bid	\$ No Bid
7	No Warranty on Liner	Liner (Trash Receptacles - Mounted Hanging)	Each	1	10	\$ 42.00	\$ 42.00
8	5 years on Material, 1 year on paint	Bench - Free Standing	Each	1	10	\$ 745.00	\$ 745.00
9	N/A	Shelter Type I (8.5' x 4.5' x 8')	Each	1	10	\$ No Bid	\$ No Bid
10	5 years on Material, 1 year on paint	Bench for Type I Shelter	Each	1	10	\$ 745.00	\$ 745.00
11	N/A	Shelter Type II (12' x 4.5' x 8')	Each	1	10	\$ No Bid	\$ No Bid
12	5 years on Material, 1 year on paint	Bench for Type II Shelter	Each	1	10	\$ 1,075.00	\$ 1,075.00
13	N/A	Shelter Type III (16' x 4.5' x 8')	Each	1	10	\$ No Bid	\$ No Bid
14	5 years on Material, 1 year on paint	Bench for Type III Shelter	Each	1	10	\$ 1,075.00	\$ 1,075.00

The award will be based upon the total sum of both columns above. No additional multipliers or quantities will be used.

NOTE: THE CITY RESERVES THE RIGHT TO ADD OR DELETE LOCATIONS, SERVICES, ITEMS, MATERIALS OR ANY OTHER ASPECTS OF CONSIDERATION FROM THIS CONTRACT SHOULD IT BE IN THE BEST INTEREST OF THE CITY. THE CONTRACT PRICE WILL BE ADJUSTED ACCORDINGLY UPON MUTUAL NEGOTIATION AND AGREEMENT OF THE CONTRACTOR AND THE CITY'S REPRESENTATIVE.

LOCAL PREFERENCE (check one) - NOT APPLICABLE

Local preference is requested YES NO

A copy of your Business tax receipt and Zoning Compliance Permit should be submitted with your bid if a local preference is requested.

QUALIFIED LOCAL SMALL BUSINESS STATUS (check one)

Is your business qualified as a Local Small Business in accordance with the City of Gainesville Small Business Procurement Program? (Refer to Definitions) YES NO

SIGNATURE ACKNOWLEDGES THAT: (check one)

- Bid is in full compliance with the Specifications.
- Bid is in full compliance with specifications except as specifically stated and attached hereto.

Signature also acknowledges that Bidder has read the cur Federal Transit Administration requirements (refer to the Technical Specifications) and agrees that the provisions thereof shall apply to this bid.

(CORPORATE SEAL)

ATTEST:

Denise Kiminki
Signature

By: Denise Kiminki

Title: CAO

BIDDER:

Jack Edgemon
Signature

By: Jack Edgemon

Title: President

TABULATION OF SUBCONTRACTORS AND MATERIAL SUPPLIERS

The Undersigned states that the following is a complete list of the proposed Subcontractors and Material Suppliers on this Project and the class of work to be performed by each, and that such list will not be added to nor altered without written consent of the City of Gainesville. This form should be completed and submitted with the bid.

Please TYPE or PRINT legibly. Use additional sheets as necessary.

SUBCONTRACTORS

Company Name	Company Phone Number	Class of Work	% or Price of Work	Disadvantaged Business Entity
1. No Subcontractors will be utilized				
2.				
3.				
4.				
5.				

MATERIALS SUPPLIERS

Company Name	Company Phone Number	Type of Supply/Material	% or Price of Materials	Disadvantaged Business Entity
1. Joseph T. Ryerson & Son	904-783-8855	Steel & Metal Materials	Variable	<input type="checkbox"/> Yes <input checked="" type="checkbox"/> No
2. Sherwin Williams	904-233-4454	Paint and Powder Coating Materials	Variable	<input type="checkbox"/> Yes <input checked="" type="checkbox"/> No
3.				<input type="checkbox"/> Yes <input type="checkbox"/> No
4.				<input type="checkbox"/> Yes <input type="checkbox"/> No
5.				<input type="checkbox"/> Yes <input type="checkbox"/> No

Bidding Company Name: PRIDE Enterprises

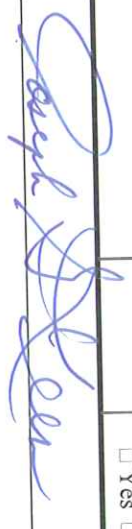
Form Completed By: 

Date: March 31, 2017

Title: Sales Support Center Manager

DRUG FREE WORKPLACE FORM

The undersigned vendor in accordance with Florida Statute 287.087 hereby certifies that

Prison Rehabilitative Industries & Diversified Enterprises, Inc. DBA: PRIDE Enterprises does:
(Name of Business)

1. Publish a statement notifying employees that the unlawful manufacture, distribution, dispensing, possession, or use of a controlled substance is prohibited in the workplace and specifying the actions that will be taken against employees for violations of such prohibition.
2. Inform employees about the dangers of drug abuse in the workplace, the business's policy of maintaining a drug-free workplace, any available drug counseling, rehabilitation, and employee assistance programs, and the penalties that may be imposed upon employees for drug abuse violations.
3. Give each employee engaged in providing the commodities or contractual services that are under bid a copy of the statement specified in subsection (1).
4. In the statement specified in subsection (1), notify the employees that, as a condition of working on the commodities or contractual services that are under bid, the employee will abide by the terms of the statement and will notify the employer of any conviction of, or plea of guilty of nolo contendere to, any violation of Chapter 893, Florida Statutes, or of any controlled substance law of the United State or any state, for a violation occurring in the workplace no later than five (5) days after such conviction.
5. Impose a sanction on, or require the satisfactory participation in a drug abuse assistance or rehabilitation program if such is available in the employee's community, by any employee who is so convicted.
6. Make a good faith effort to continue to maintain a drug-free workplace through implementation of this section.

As the person authorized to sign the statement, I certify that this firm complies fully with the above requirements.

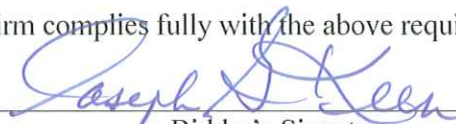
Bidder's Signature

March 31, 2017
Date

DEBARRED AND SUSPENDED BIDDERS

Breach of Contract

1. Scope.
This policy prescribes policies and procedures relating to:
 - (a) the debarment of bidders for cause;
 - (b) the suspension of bidders for cause under prescribed conditions; and,
 - (c) the rejection of bids, revocation of acceptance and termination of contracts for cause.
It is directly applicable to the advertised and negotiated purchases and contracts, for equipment and services of the City.
2. General.
Debarment and suspension are measures which may be invoked by the City either to exclude or to disqualify bidders and contractors from participation in City contracting or subcontracting. These measure should be used for the purpose of protecting the interests of the City and not for punishment. To assure the City the benefits to be derived from the full and free competition of interested bidders, these measures should not be instituted for any time longer than deemed necessary to protect the interests of the City, and should preclude awards only for the probably duration of the period of non-responsibility.
- 2.1 Definitions.
 - (a) "Debarment" means, in general, an exclusion from City contracting and subcontracting for a reasonable, specified period of time commensurate with the seriousness of the offense, improper conduct or the inadequacy of performance.
 - (b) "Suspension" means a disqualification from City contracting and subcontracting for a temporary period of time because a concern or individual is suspected upon adequate evidence (See Section 6) of engaging in criminal, fraudulent, improper conduct or inadequate performance.
 - (c) A "debarment list" or "debarred bidders list" means a list of names of concerns or individuals against whom any or all of the measures referred to in this policy have been invoked.
 - (d) "Bidders" means, wherever the term is used in this policy, an offerors bidding pursuant to an invitation for bids or a request for proposals.
 - (e) "Affiliates" means business concerns which are affiliates of each other when either directly or indirectly one concern or individual controls or has the power to control another, or when a third party controls or has the power to control both.
 - (f) "Business operations" means commercial or industrial activity engaged in regularly and continuously over a period of time for the purpose of receiving pecuniary benefit or otherwise accomplishing an objective. "Business operations" constitute and are equivalent to "carrying on business", "engaged in business", "doing business".
3. Establishment and Maintenance of a List of Concerns or Individuals Debarred or Suspended.
 - (a) The Purchasing Department shall establish and maintain on the basis contained in Sections 6 and 6.1, a consolidated list of concerns and individuals to whom contracts will not be awarded and from whom bids or proposals will not be solicited.
 - (b) The list shall show as a minimum the following information:
 - (1) the names of those concerns or individuals debarred or suspended (in alphabetical order) with appropriate cross-reference where more than one name is involved in a single action;
 - (2) the basis of authority for each action;
 - (3) the extent of restrictions imposed; and,
 - (4) the termination date for each debarred or suspended listing.
 - (c) The list shall be kept current by issuance of notices of additions and deletions.
4. Treatment to be Accorded Firms or Individuals Debarred or Suspended
Firms or individuals listed by the Purchasing Department as debarred or suspended shall be treated as follows.
 - (a) Total restrictions. A contract shall not be awarded to a concern or individual that is listed on the basis of a Section 5(a)(1), (2) or (3) felony "conviction", or to any concern, corporation, partnership, or association in which the listed concern or individual has actual control or a material interest; nor shall bids or proposals be solicited therefrom. However, when it is determined essential in the public interest by the City Commission, an exception may be made with respect to a particular procurement action where the individual or concern is effectively the sole source of supply or it is an emergency purchase.
 - (b) Restrictions on subcontracting. If a concern or individual listed on the debarred and suspended bidders list is proposed as a subcontractor, the Purchasing Department shall decline to approve subcontracting with that firm or individual in any instance in which consent is required of the City before the subcontract is made, unless it is determined by the City to grant approval City Commission essential to public interest and the individual or concern is effectively the sole source of supply or it is an emergency purchase.
5. Causes and Conditions Applicable to Determination of Debarment.

Exhibit A

Subject to the following conditions, the Purchasing is authorized to debar a firm or individual in the public interest for any of the following causes occurring with ten (10) years of debarment.

- (a) Causes
- (1) "Conviction" for commission of a criminal offense as an incident to obtaining or attempting to obtain a public or private contract, or subcontract thereunder, or in the performance of such contract or subcontract.
 - (2) "Convictions" of embezzlement, theft, forgery, issuance of worthless checks, bribery, falsification or destruction of records, perjury, or receiving stolen property where the conviction is based upon conduct which arose out of, or was related to, business operations of the bidder.
 - (3) "Conviction" for bid-rigging activities arising out of the submission of bids or proposals.
 - (4) Violation of contract provisions, as set forth below, of a character which is regarded by the City to be so serious as to justify debarment action:
 - (i) willful failure to perform in accordance with the specifications or within the time limit provided in the contract;
 - (ii) a record of failure to perform or of unsatisfactory performance in accordance with the terms of one or more contracts. Failure to perform or unsatisfactory performance caused by acts beyond the control of the firm or individual as a contractor shall not be considered to be a basis for debarment.
 - (5) Debarment by any other governmental agency.

(b) Conditions.

- (1) Debarment for any of the causes set forth in this section shall be made only upon approval of the Purchasing.
- (2) The existence of any of the causes set forth in (a) of this section does not necessarily require that a firm or individual be debarred except as provided in 4(a). In each instance, whether the offense or failure, or inadequacy of performance, be of criminal, fraudulent, or serious nature, the decision to debar shall only be made if supported by a preponderance of the credible evidence available. Likewise, all mitigating factors may be considered in determining the seriousness of the offense, failure, or inadequacy of performance, in deciding whether debarment is warranted. The actual or apparent authority of an involved individual, the present relationship of involved individuals with the bidder, the past performance of the individual or concern, and the relationship of the violation to the services or materials involved shall be considered.
- (3) The existence of a cause set forth in (a)(1), (2), and (3) of this section shall be established by criminal "conviction" by a court of competent jurisdiction. In the event that an appeal taken from such conviction results in reversal of the "conviction", the debarment shall be removed upon the request of the bidder (unless other causes for debarment exists). For the purposes of this policy, the following shall have the same effect as a "conviction": pleading guilty or nolo contendere, or being found guilty by a jury or court of, the offense in question, regardless of whether probation is imposed and adjudication withheld.
- (4) The existence of a cause set forth in (a)(4) and (5) of this section shall be established by a preponderance of credible evidence by the Purchasing.
- (5) Debarment for the cause set forth in (a)(5) of this section (debarment by another agency) shall be proper if one of the causes for debarment set forth in (a)(1) through (4) of this section was the basis for debarment by the original debarring agency. Such debarment may be based entirely on the record of facts obtained by the original debarring agency, or upon a combination of such facts and additional facts.

5.1 Period of Debarment.

- (a) Debarment of a firm or individual shall be for a reasonable, definitely stated period of time commensurate with the seriousness of the offense or the failure or inadequacy or performance. As a general rule, a period of debarment shall not exceed five (5) years. However, when partial or total debarment for an additional period is deemed necessary, notice of the proposed additional debarment shall be furnished to that concern or individual in accordance with Section 8.
- (b) A debarment may be removed or the period thereof may be reduced by the City Manager upon the submission of an application supported by documentary evidence, setting forth appropriate grounds for the granting of relief; such as newly discovered material evidence, reversal of a conviction, bona fide change of ownership or management, or the elimination of the causes for which the debarment was imposed. The City Manager may request additional information, shall consider all relevant facts, and shall render a decision within twenty (20) days of receipt of the application unless a longer period is warranted under the circumstances.

6. Suspension of Bidders.

- (a) Suspension is a drastic action and, as such, shall not be based upon an unsupported accusation. In assessing whether evidence exists for invoking a suspension, consideration should be given to the amount of credible evidence which is available, to the existence or absence of corroboration as to important allegations, as well as to the inferences which may properly be drawn from the existence or absence of affirmative facts. This assessment should include an examination of basic documents, such as contracts, inspection reports, and correspondence. In making a determination

- to suspend, the Purchasing shall consider the factors set forth in Section 5(b)(2). A suspension may be modified by the City Manager as described in Section 5.1(b).
- 6.1 Causes and Conditions Under Which the City May Suspend Contractors
- (a) The Purchasing may, in the interest of the City, suspend a firm or individual when the firm or individual is suspected, upon credible evidence, of having committed one or more the following act(s) within three (3) years of the date of suspension:
- (1) Commission of fraud or a criminal offense as an incident to obtaining, attempting to obtain, or in the performance of a public contract;
 - (2) Violation of statutes concerning bid-rigging activities out of the submission of bids and proposals; and,
 - (3) Commission of embezzlement, theft, forgery, issuance of worthless checks, bribery, falsification, or destruction of records, perjury, receiving stolen property. Commission of any other offense indicating a lack of business integrity or business honesty which seriously and directly affects the question of present responsibility as a City contractor.
- 6.2 Period of Suspension.
- (a) All suspension shall be for temporary period pending the completion of an investigation and such legal proceedings as may ensue. In the event that prosecution has not been initiated within twelve (12) months form the date of the suspension, the suspension shall be terminated. Upon removal of suspension, consideration may be given to debarment in accordance with Section 5 of this policy.
7. Scope of Debarment or Suspension.
- (a) A debarment or suspension may include all known affiliates of a concern or individual.
 - (b) Each decision to include a known affiliate within the scope of a proposed debarment or suspension is to be made on a case-by-case basis, after giving due regard to actual or apparent authority of the controlling concern or individual and similarity of the services provided by the affiliate to those provided by the debarred individual or concern.
 - (c) The criminal, fraudulent, or seriously improper conduct of an individual may be imputed to the business concern with which he is connected, where such impropriety was accomplished within the course of his official duty or apparent authority, or was effected by him with the knowledge and approval of that concern. When the individual was an officer of the concern, knowledge and approval may be presumed. Likewise, where a concern is involved in criminal, fraudulent, or seriously improper conduct, any individual who was involved in the commission of the impropriety may be debarred or suspended.
8. Notice of Debarment of Suspension.
- When the Purchasing seeks to debar or suspend a concern or individual (or any affiliate thereof) for cause, it shall furnish that party with a written notice:
- (1) stating that debarment or suspension is being considered;
 - (2) setting forth the reasons for the proposed action;
 - (3) indicating that such party will be afforded an opportunity for a hearing if he so requests one within ten (10) days; and,
 - (4) indicating that such party may make a written response in accordance with Section 9(a).
9. Response to Notice of Debarment or Suspension.
- (a) In lieu of requesting a hearing within the prescribed ten (10) day period, the party may, within said ten (10) day period, notify the City of its intent to provide a written reply and submit written evidence to contest the debarment or suspension. Such written evidence must be submitted within twenty (20) days after receipt of the notice of proposed debarment or suspension in order for it to be considered.
 - (b) Whatever response is received to the notice of intent to debar or suspend, such will be considered in determining whether debarment or suspension action will be made. Where a reply is received to the notice of intent to debar or to suspend, and evidence to refute such action is furnished but no hearing is requested, the information furnished will be considered in determining the action to be taken.
 - (c) If a hearing is requested, it shall be conducted by the City Manager. The hearing will be held at a location convenient to the City as determined by the City Manager and on a date and at a time stated. An opportunity shall be afforded to the firm or individual to appear with witnesses and counsel, to present facts or circumstances showing cause why such firm or individual should not be debarred or suspended. The proceeding shall be of an informal nature as determined by the City Manager. After consideration of the facts, the City Manager shall notify the firm or individual of the final decision.
 - (d) If no response is made to the notice of debarment or suspension within the first ten (10) day period, the decision of the Purchasing shall be deemed final and the party so notified.
10. Rejection of Bids, Breach of Contract.
- (a) Previously solicited and/or accepted bids may be rejected or acceptance revoked prior to beginning of performance upon discovery by the City that the bidder or its affiliates have committed any act which would have been cause for debarment.

Exhibit A

- (b) If after a contract is awarded and performance has been begun the City discovers that the bidder or its affiliates have committed any act prior to award or acceptance which would have been cause for debarment had it been discovered prior to solicitation or acceptance, the City may consider such to be a material breach of the contract and such shall constitute cause for termination of the contract.
- (c) If after bids have been solicited and/or accepted or after a contract is awarded and performance begun, the City discovers that the bidder or its affiliates committed any act prior to award or acceptance which would have been cause for disbarment or suspension had it been discovered prior to solicitation or acceptance, the City may require additional satisfactory assurances that such act(s) have not occurred and that the contract can and will be faithfully performed. If additional assurances are requested and are not satisfactory or if the bidder or its affiliates fail to immediately cooperate with all reasonable requests, including requests for information reasonably calculated to lead to the discovery of relevant evidence, then such may be considered a material breach of the contract and such shall constitute cause for termination of the contract.

LOCAL SMALL BUSINESS PROGRAM – NOT APPLICABLE

It is the policy of the City of Gainesville that Local Small Businesses shall have the maximum opportunity to participate in the performance of all aspects of contracting and subcontracting opportunities for the City of Gainesville. In this regard, the City of Gainesville and its contractors will take all necessary and reasonable steps to ensure that Local Small Businesses have the maximum opportunity to compete for and perform such contracts/subcontracts and provide materials for such contracts/subcontracts.

Except as provided below, evaluation of a bid/proposal may result in bid/proposal being rejected for failure to comply with the following conditions. Upon contract award, failure of any Bidder/Proposer to comply with these conditions/requirements which seek to maximize the use of Local Small Businesses shall constitute a breach of a contract award. Upon such breach, the City of Gainesville may at its option, terminate the contract and/or pursue any and all other appropriate remedies available under the contract or otherwise under applicable law.

Contract Award Conditions:

Contract award will be conditioned on meeting the requirements of this section. The City of Gainesville requires the following:

1. Submission by the Bidder/Proposer of the completed "Tabulation of Subcontractors" form (BF-4) with the bid/proposal;
2. The names and addresses of all Subcontractors. Clearly designate which Subcontractors are Local Small Businesses that will participate in the contract;
3. A description of the Work and/or Materials that each Local Small Businesses will perform or supply;
4. The dollar amount or percentage of the Work and/or Materials that each Local Small Business will provide on the project.
5. If the actual participation of Local Small Business in the apparently successful bid/proposal is not maximized, as determined by the Local Small Business Procurement Program Coordinator, such bidder/proposer shall submit documentation of all Good Faith Efforts (successful and unsuccessful) that were engaged in, prior to bid or proposal submission, to maximize the use of Local Small Businesses on this project. Efforts undertaken after bid submissions are not relevant to the decision to award.

Good Faith Efforts:

A condition of contract award is that the contract award be made only to the Bidder/Proposer (including Local Small Business Bidders/Proposers) who maximize the utilization of Local Small Business subcontractors or who makes Good Faith Efforts to maximize the use of Local Small Business Subcontractors. The City of Gainesville will determine whether a Bidder/Proposer has made Good Faith Efforts if the Bidder/Proposer does the following:

If the Bidder/Proposer does not maximize the participation of Local Small Businesses on this project, the Bidder/Proposer must provide all documentation which by its scope, quality, quantity and intensity of the different kinds of efforts the Bidder/Proposer made to maximize participation can be confirmed and be evaluated. The documentation should be provided both as to those efforts wherein the Bidder/Proposer was successful in obtaining participation and those where it was not. In the latter case, the documentation should further indicate the reason for lack for success, i.e. Subcontractor's bid too high, Subcontractor who bids is apparently not qualified to perform the particular services, no bids received, etc.

Mere pro forma efforts are not Good Faith Efforts to meet the Local Small Business requirements. The Bidder/Proposer will be required to submit written documentation of Good Faith Efforts when the participation on this project is not maximized, if they wish to be awarded the contract.

The City of Gainesville will consider the following list of types of actions as a part of the Bidder's/Proposer's Good Faith Efforts to obtain Local Small Business Subcontractor participation. It is not intended to be a mandatory checklist, nor is it intended to be exclusive or exhaustive. Other factors or types of efforts may be relevant in appropriate cases.

1. Soliciting through all reasonable and available means (e.g. attendance at pre-bid meetings, advertising and/or written notices) the interest of all Local Small Business who have the capability to perform the Work or provide Materials needed to complete the project. The Bidder/Proposer must solicit this interest within sufficient time to allow them to respond to the solicitation.

Exhibit B

The Bidder/Proposer must determine with certainty if they are interested by taking appropriate steps to follow-up the initial solicitations.

2. Selecting portions of the Work to be performed or portions of the Materials to be provided by Local Small Businesses in order to increase the likelihood that participation is maximized. This includes, where appropriate, breaking out contract Work items or Material items into economically feasible units to facilitate participation, even when the prime contractor might otherwise prefer to perform these Work items or provide these Material items with its own forces.
3. Providing interested Local Small Businesses with adequate information about the plans, specifications and requirements of the contract in a timely manner to assist them in responding to a solicitation.
4. (a) Negotiating in good faith with interested Local Small Businesses. It is the Bidder's/Proposer's responsibility to make a portion of the Work or Materials available to the Subcontractors and to select those portions of the Work or Material needed consistent with the available Local Small Business Subcontractors, so as to facilitate participation. Evidence of such negotiation includes the names, addresses and telephone numbers of Local Small Businesses that were considered; a description of the information provided regarding the plans and specifications for the Work or Materials selected for subcontracting; and evidence as to why additional agreements could not be reached to perform the Work or provide the Materials.
- (b) A Bidder/Proposer using good business judgment would consider a number of factors in negotiating with Subcontractors, and would take a firm's price and capabilities into consideration. However, the fact that there may be some additional costs involved in finding and using Local Small Businesses is not in itself sufficient reason for a Bidder/Proposer's failure to seek to maximize the use of them as long as such costs are reasonable and/or may be offset by other less tangible benefits. Also, the availability or desire of a Bidder/Proposer, including a Local Small Business Bidder/Proposer to perform the Work or provide the Materials of a contract with its own organization does not relieve the Bidder/Proposer the responsibility to make Good Faith Efforts and maximize utilization of other Local Small Businesses. Bidder/Proposers are not, however, required to accept higher quotes from Local Small Businesses if the price difference is excessive or unreasonable or they are not qualified to perform the Work. These decisions should, however, be supportable and documented as part of the required Good Faith Efforts.
5. Making efforts to assist interested Local Small Businesses in obtaining bonding, lines of credit, or insurance as required by the City of Gainesville or Bidder/Proposer.
6. Making efforts to assist interested Local Small Businesses in obtaining necessary equipment, supplies, Materials, or related assistance and services.
7. Effectively using the services of available small and minority business assistance offices; and other organizations as allowed on a case-by-case basis to provide assistance in the recruitment and placement of Local Small Businesses.

In determining whether a Bidder/Proposer has maximized participation, the City of Gainesville will take into account the performance of other Bidders/Proposers in meeting this requirement of the bid/proposal and historical participation by Local Small Businesses involving similar Work or Materials. For example, when the apparent successful Bidder/Proposer fails to obtain or fails to maximize Local Small Business participation, but others Bidders/Proposers obtained and/or maximized such participation, the City of Gainesville will reasonably raise questions whether, with additional reasonable efforts, the apparent successful Bidder/Proposer could have obtained and/or maximized participation. As indicated, a reasonable level of participation (maximization) may not be apparent until after bids/proposals are opened and participation of various bidders compared. Therefore, it is recommended that in all cases, all pre-submittal Good Faith Efforts be documented, and retained in the event that such are required to be submitted for review/verification.

Even if a Bidder/Proposer is a Local Small Business, maximizing the utilization of other Local Small Businesses is still required.

Local Small Businesses Terminations/Substitutions:

A Bidder/Proposer shall not terminate for convenience a Local Small Business Subcontractor and then perform the Work or provide the Materials of the terminated Subcontractor within its own forces or those of an affiliate without the prior consent of the City of Gainesville.

When a Local Small Business Subcontractor is terminated or fails to complete its Work or fails to provide the Materials on the contract for any reason, the prime contractor shall make Good Faith Efforts to find another Local Small Business subcontractor to substitute for the original Local Small Business. These Good Faith Efforts shall be directed at finding another Local Small Business to perform at least the same amount of Work or provide the same amount of Materials under the contract as the business that was terminated to the extent needed to meet the contract goal or commitment.

The City of Gainesville shall have the right to consider price, quality, past performance including meeting Small Business Procurement Program commitments, time required for performance and qualifications of the Bidder/Proposer in making the award.

Equal Opportunity Assurance:

The contractor, sub recipient, or Subcontractor shall not discriminate on the basis of race, color, religion, gender, national origin, marital status, sexual orientation, age, disability, and gender identity in the performance of this contract. Failure by the contractor to carry out these requirements is a material breach of his contract, which may result in termination of this contract or such other remedy as the recipient deems appropriate.

The Contractor shall include this assurance in each subcontract it signs with a Subcontractor or Material Supplier.

Protest of Rejected Bid/Proposal – Administrative Reconsideration

1. The Local Small Business Procurement Program Coordinator shall review bids and proposals to evaluate whether said bids or proposals comply with the above stated requirements. In the event that a bid or proposal is rejected for failure to comply with the stated requirements, the affected bidder or proposer may obtain reconsideration of such determination by filing a Protest/Request for Reconsideration.
2. In the reconsideration, the Bidder/Proposer has the opportunity to demonstrate how the Bid/Proposal met the requirements of the Program. The Request for Reconsideration shall be submitted to the Small Business Procurement Program Office within five (5) working days after receipt of notice of rejection. The Request for Reconsideration shall address the issues of whether the Bidder/Proposer maximized Local Small Business participation or made adequate good faith efforts to maximize the participation of local small business participation and shall include documentation associated with these factors.
3. The decision on reconsideration will be made by the Administrative Services Director.
4. The Bidder/Proposer may have the opportunity to meet in person with the Administrative Services Director to discuss the issue of whether it met the criteria outlined above (see Item 2).
5. The Bidder/Proposer will be sent a written decision on reconsideration, explaining the basis for finding that the Bidder/Proposer did or did not meet the criteria above. (see Item 2).
6. All the arguments, documentation, and evidence, which is relevant to the Request for Reconsideration must be submitted by the Bidder/Proposer to the Administrative Services Director at least three (3) working days prior to the meeting described in Item 4 above or, if no meeting is held, three (3) days prior to the anticipated date of the decision on reconsideration. Absent fraud or mistake not attributable to the Bidder/Proposer, evidence of efforts undertaken subsequent to submission of the bid/proposal will not be considered. If no additional evidence or documentation is submitted by the Bidder/Proposer in accordance with the above, only the documents currently on file with the Purchasing Division will be reviewed at the meeting.

Sales Support Center
568 Northeast 255th Street
Cross City, Florida 32628



#160969G
813.890.2175 office
866.528.2175 fax
877.283.6819 toll free



PRIDE Enterprises
Sales Support Center and Bids
P.O. Box 440
Cross City, FL 32628

Contact: Jason Brown
Phone: (813) 890-6582
Fax: (727) 570-3449
E-Mail: bids@pride-enterprises.org
Web: www.pride-enterprises.org

Attachments “A-1 thru A-6”

Product Drawings

Please note:

The Free Standing Bench would be (1) 6' Bench (Item #41104040101-10).

The Type I Shelter Bench would be (1) 8' Bench (Item# 41104040102-10).

The Type II Shelter Benches would be (2) 6' Benches (Item# 41104040101-10).

The Type III Shelter Benches would be (2) 8' Benches (Item# 41104040102-10).

The drawings provided in this proposal are particular to the specifications set forth in this bid.

For a more general description of like products offered please see enclosed hardcopy of

PRIDE's Outdoor Products catalog.

Sales Support Center
568 Northeast 255th Street
Cross City, Florida 32628



#160969G
813.890.2175 office
866.528.2175 fax
877.283.6819 toll free



PRIDE Enterprises
Sales Support Center and Bids
P.O. Box 440
Cross City, FL 32628

Contact: Jason Brown
Phone: (813) 890-6582
Fax: (727) 570-3449
E-Mail: bids@pride-enterprises.org
Web: www.pride-enterprises.org

Attachment "A-1"

Bike Rack Drawing

8	7	6	5	4	3	2	1
ZONE REV.	DESCRIPTION	DATE	DRAWN BY	APPROVED BY	ECN #		

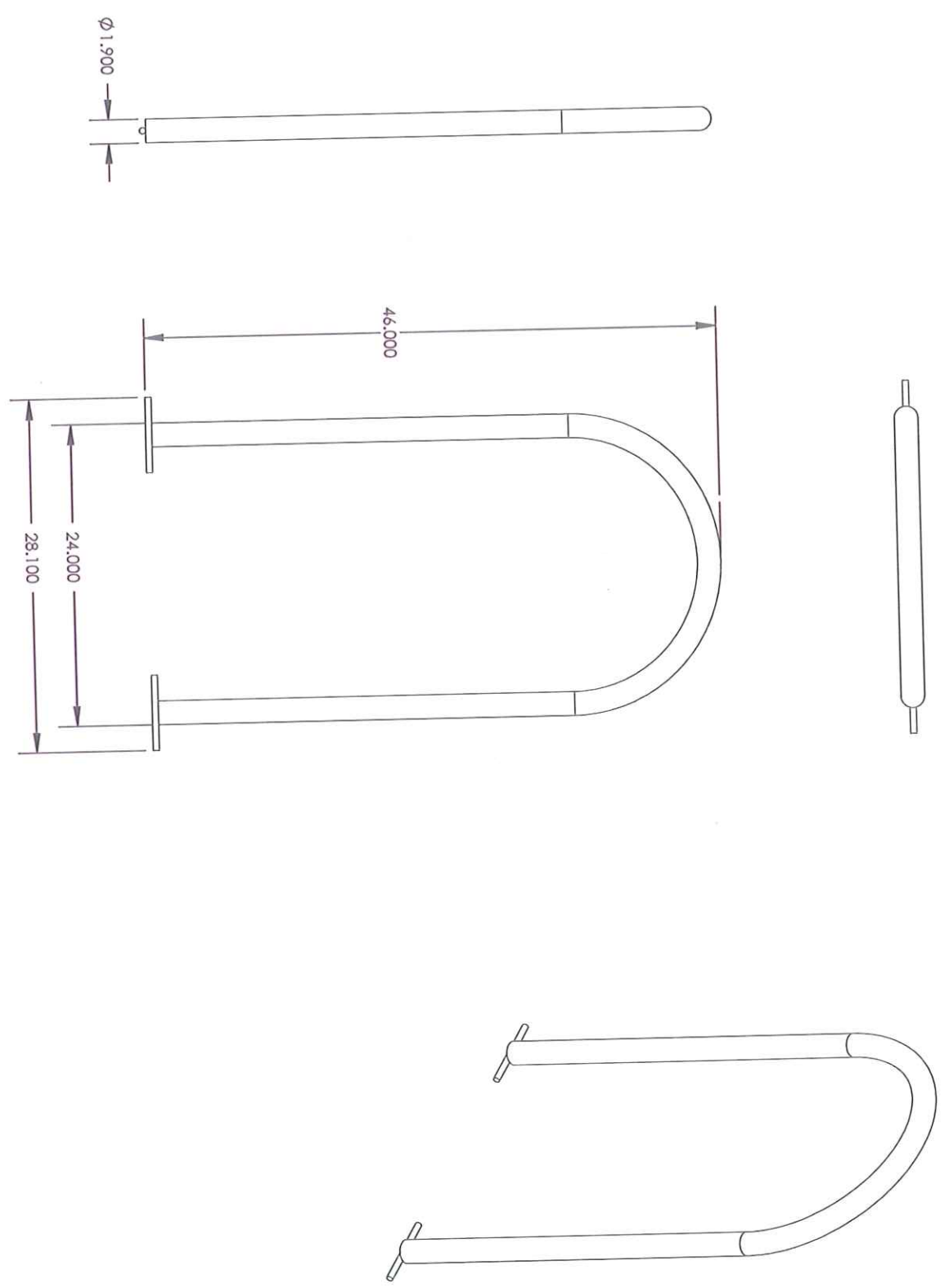

PRIDE METAL PRODUCTS DIVISION
 13518 NE 258th CT - RAIFORD, FL 32083
 PH: 813-890-6556 FAX: 813-890-2119

IMPACT THROUGH INDUSTRIES

DATE: 2/6/2016 10:02:00 AM ORDER AND DRAWING DO NOT MANUALLY UPDATE REMOVED ALL BUBBLES & WILD SPACES SCALE: 1:12 ANGLE: 90	DATE: 12/6/2016 10:02:00 AM CUSTOMER: KENNEDY ORDER NUMBER: HW-255620 ORDER BY: HASKIE ORDER NUMBER: 23,790	TITLE: BIKE RACK, SINGLE PART NUMBER: 4112040102-01 SHEET: A SHEETS: 1:12 SHEET 1 OF 1	DEV
-----------------------------------------------------------------------------------------------------------------------------------------	-------------------------------------------------------------------------------------------------------------------------	----------------------------------------------------------------------------------------------------	-----

THE INFORMATION CONTAINED IN THIS DRAWING IS THE SOLE PROPERTY OF PRIDE METAL PRODUCTS, INC. ANY REPRODUCTION IN PART OR WHOLE WITHOUT THE WRITTEN PERMISSION OF PRIDE METAL PRODUCTS, INC. IS PROHIBITED.

Sales Support Center
568 Northeast 255th Street
Cross City, Florida 32628



#160969G
813.890.2175 office
866.528.2175 fax
877.283.6819 toll free



PRIDE Enterprises
Sales Support Center and Bids
P.O. Box 440
Cross City, FL 32628

Contact: Jason Brown
Phone: (813) 890-6582
Fax: (727) 570-3449
E-Mail: bids@pride-enterprises.org
Web: www.pride-enterprises.org

Attachment "A-2"

Trash Receptacle Drawing

8	7	6	5	4	3	2	1
ZONE 1 REV.	DESCRIPTION	DATE	DRAWN BY	APPROVED BY	ECN #		

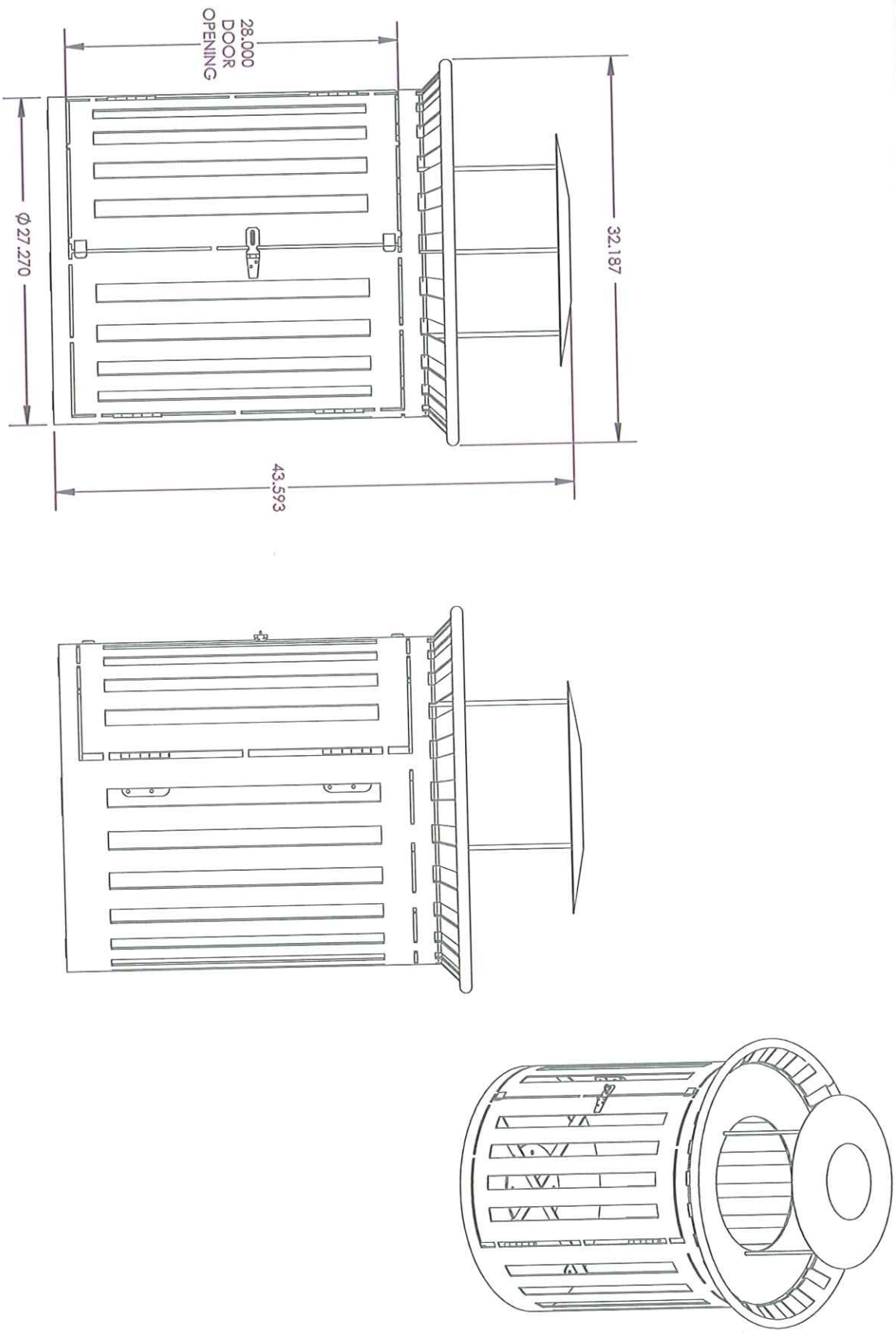

PRIDE METAL PRODUCTS DIVISION
 13518 NE 258th Ct - RAIFORD, FL 32083
 PH: 813-890-5556 FAX: 813-890-2119

IMPACT THROUGH INDUSTRIES

DATE: 9/31/2016 9:42:29 AM	DATE: 12/21/2017 9:58:51 AM	DESIGNER: KENNEDY	DATE: 11/26/16	DRAWN BY: KENNEDY	DATE: 1/3/97	HEIGHT: 28.000	WIDTH: 32.187	DEPTH: 41111040101-06	RECEPTACLE, TRASH
ORDER REMOVED FOR REVISIONS DO NOT MANUALLY UPDATE REMOVE ALL DIMS & WELD SYMBOLS TOLERANCES ARE IN INCHES DIMS: 1/16 ANGLES: 3/16		THE INFORMATION CONTAINED IN THIS DRAWING IS THE SOLE PROPERTY OF PRIDE ENTERPRISES, INC. ANY REPRODUCTION IN PART OR WHOLE WITHOUT THE WRITTEN PERMISSION OF PRIDE ENTERPRISES, INC. IS PROHIBITED.		PROJECT: 112616 PART: POWDERCOAT PART NO: 143,992	DIMENSIONS: 32.187 DIMENSIONS: 27.270 DIMENSIONS: 43.593	DIMENSIONS: 28.000 DIMENSIONS: 27.270	DIMENSIONS: 32.187 DIMENSIONS: 27.270	DIMENSIONS: 41111040101-06 DIMENSIONS: 1.24 DIMENSIONS: SHEET 1 OF 8	DIMENSIONS: RECEPTACLE, TRASH DIMENSIONS: DEV

Sales Support Center
568 Northeast 255th Street
Cross City, Florida 32628



#160969G
813.890.2175 office
866.528.2175 fax
877.283.6819 toll free



PRIDE Enterprises
Sales Support Center and Bids
P.O. Box 440
Cross City, FL 32628

Contact: Jason Brown
Phone: (813) 890-6582
Fax: (727) 570-3449
E-Mail: bids@pride-enterprises.org
Web: www.pride-enterprises.org

Attachment "A-3"

Free Standing Bench Drawing

IMPACT THROUGH INDUSTRY

www.pride-enterprises.org

ZONE	REV	8	7	6	5	4	3	2	1
DESCRIPTION	DATE	DRAWN BY	APPROVED BY	ECN #					

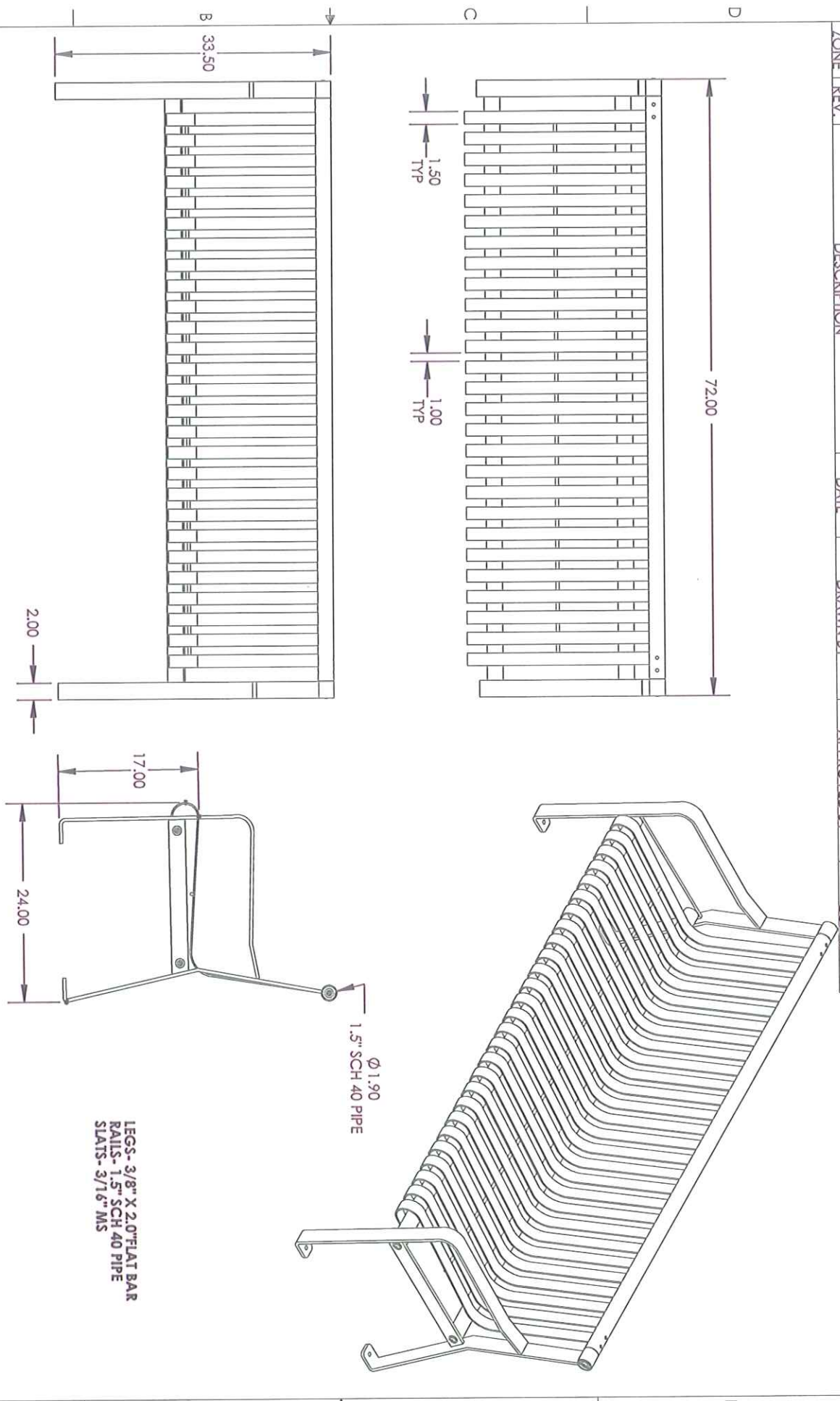

LEGS- 3/8" X 2.0" FLAT BAR
 RAILS- 1.5" SCH 40 PIPE
 SLATS- 3/16" MS

Ø 1.90
 1.5" SCH 40 PIPE

PRIDE METAL PRODUCTS DIVISION
 13518 NE 258th Ct - RAIFORD, FL 32083
 PH: 813-890-6556 FAX: 813-890-2119

DATE	9/7/2017 10:28:39 AM	DESIGNED BY	MATHEWS
GENERATED DRAWING	DO NOT MANUALLY UPDATE	DRAWN BY	MATHEWS
TOLERANCES ARE IN INCHES:		PROJECT NO.	MA-091598
XXX = .00		THE INFORMATION CONTAINED IN THIS DRAWING IS THE SOLE PROPERTY OF PRIDE ENTERPRISES INC. ANY REPRODUCTION IN WHOLE OR IN PART WITHOUT THE WRITTEN PERMISSION OF PRIDE ENTERPRISES INC. IS PROHIBITED.	
ANGLES = 1°		DRAWN BY	JISEY
		PROJECT	POWDERCOAT
		DATE	24.0"
		SCALE	61.557

PARK BENCH, STRAIGHT, SM, MS, 72"
SLATTED
 41104040101-10
 SHEET 1 OF 2

DEV

Sales Support Center
568 Northeast 255th Street
Cross City, Florida 32628



#160969G
813.890.2175 office
866.528.2175 fax
877.283.6819 toll free



PRIDE Enterprises
Sales Support Center and Bids
P.O. Box 440
Cross City, FL 32628

Contact: Jason Brown
Phone: (813) 890-6582
Fax: (727) 570-3449
E-Mail: bids@pride-enterprises.org
Web: www.pride-enterprises.org

Attachment "A-4"

Type I Shelter Bench Drawing

ZONE	REV.	DESCRIPTION	DATE	DRAWN BY	APPROVED BY	ECN #
8						
7						
6						
5						
4						
3						
2						
1						

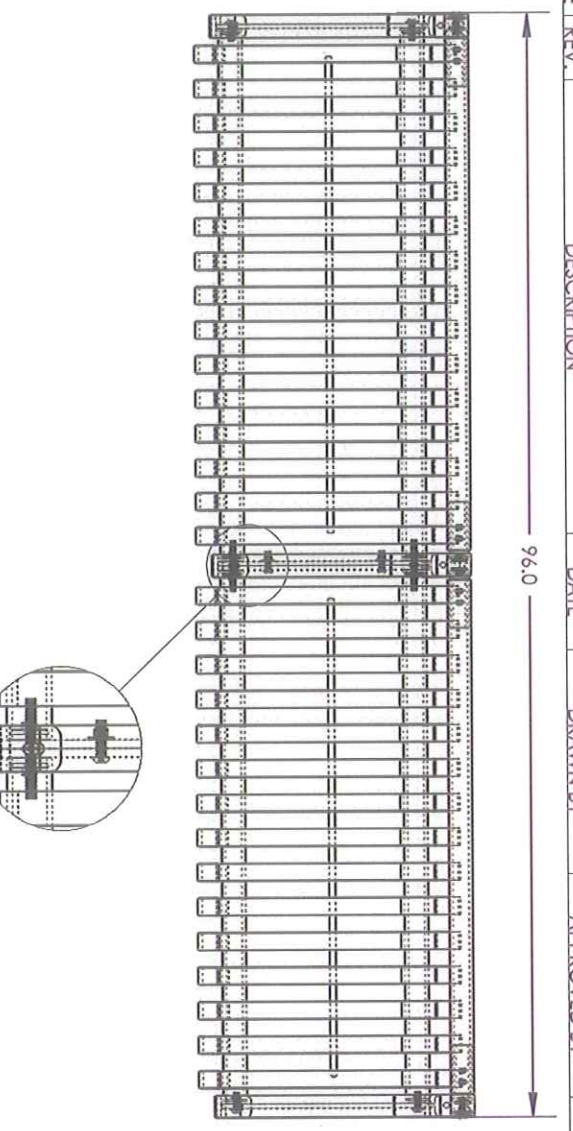

DETAIL A
SCALE 1 : 8

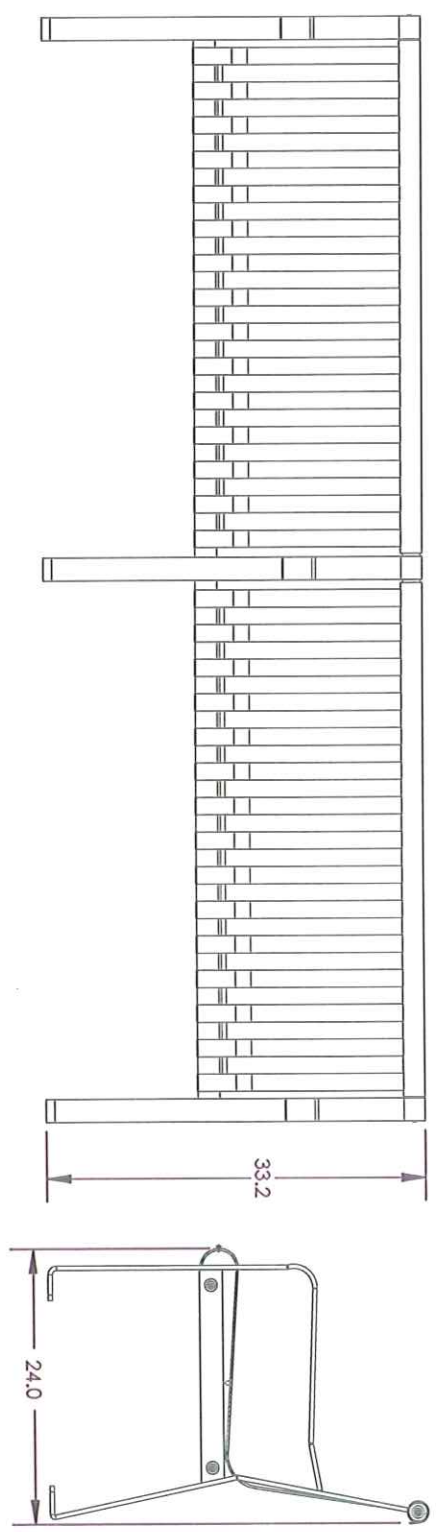
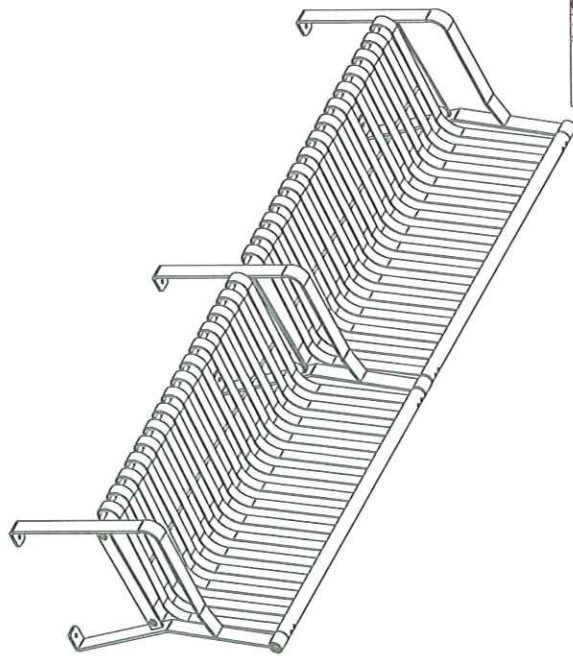

PRIDE METAL PRODUCTS DIVISION
 13518 NE 258th CT. - RAIFORD, FL 32083
 PH: 813-890-6556 FAX: 813-890-2119

DATE: 8/13/2017 2:28:29 PM
 GENERATED DRAWING: DO NOT MANUALLY UPDATE
 REMOVED ALL DIMS & WELD SPACERS

DATE: 3/13/2017 2:41:55 PM
 DRAFTER: MATHIEWS
 M-091598

DATE: 8/6/2017
 CHECKER: MATHIEWS
 HSEY
 VABIES
 86.707

PROJECT: PARK BENCH, STRAIGHT BACK, SM ALL
 MS, SLATTED, 8' WITH 3-LEGS
 41104040102-10

SCALE: A 1:24
 SHEET 1 OF 1

DEV

TOLERANCES ARE IN INCHES:
 DIMS: .005
 ANGLES: .1°
 THE INFORMATION CONTAINED IN THIS DRAWING IS THE SOLE PROPERTY OF PRIDE ENTERPRISES, INC. ANY REPRODUCTION IN PART OR WHOLE WITHOUT THE WRITTEN PERMISSION OF PRIDE ENTERPRISES, INC. IS PROHIBITED.

Sales Support Center
568 Northeast 255th Street
Cross City, Florida 32628



#160969G
813.890.2175 office
866.528.2175 fax
877.283.6819 toll free



PRIDE Enterprises
Sales Support Center and Bids
P.O. Box 440
Cross City, FL 32628

Contact: Jason Brown
Phone: (813) 890-6582
Fax: (727) 570-3449
E-Mail: bids@pride-enterprises.org
Web: www.pride-enterprises.org

Attachment "A-5"

Type II Shelter Bench Drawing

8	7	6	5	4	3	2	1
ZONE REV.	DESCRIPTION	DATE	DRAWN BY	APPROVED BY	ECN #		

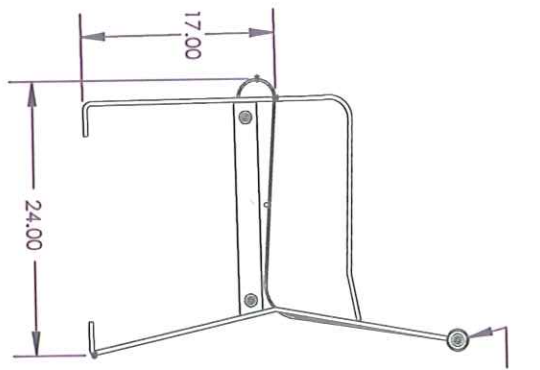
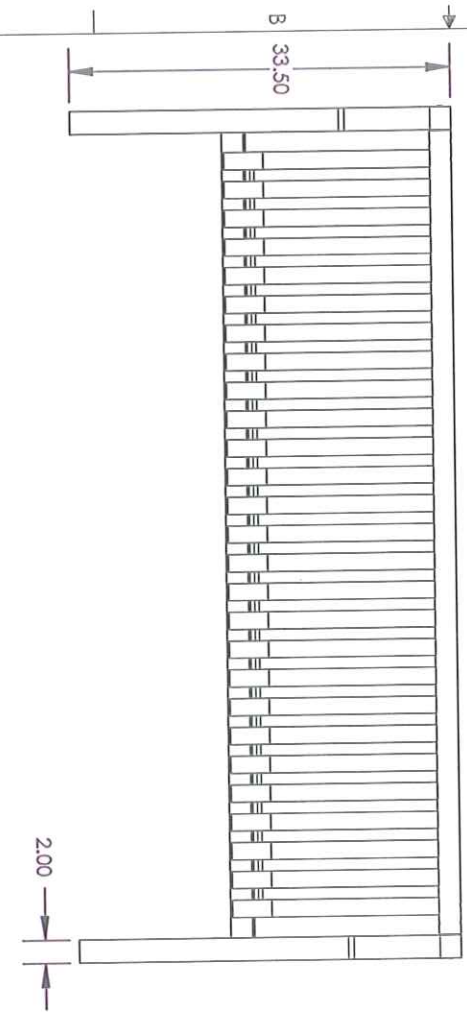
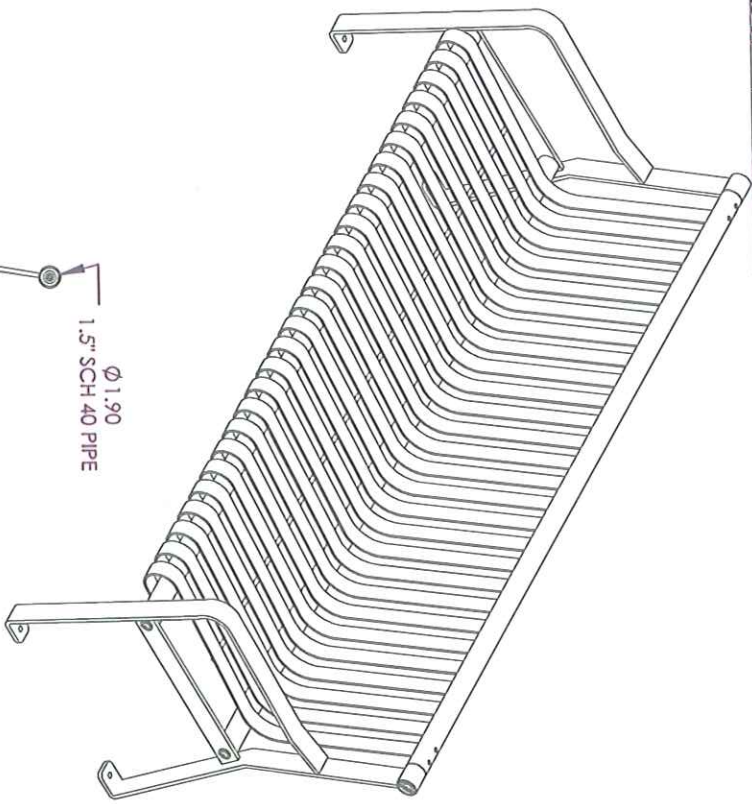
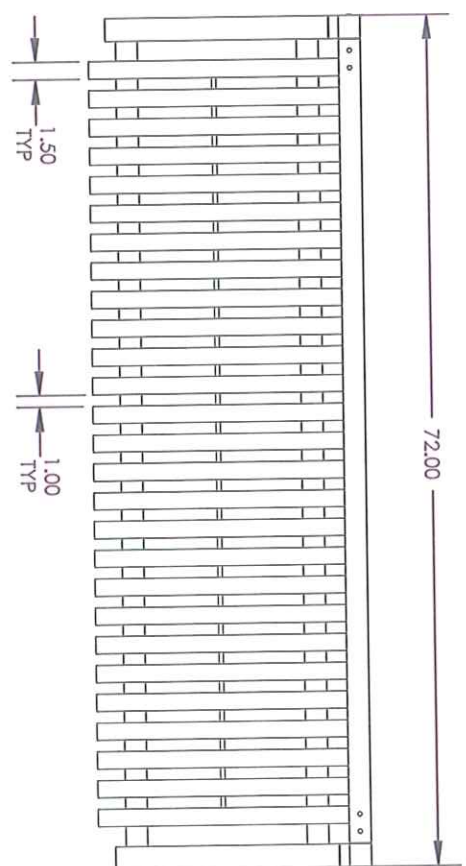

LEGS - 3/8" X 2.0" FLAT BAR
 RAILS - 1.5" SCH 40 PIPE
 SLATS - 3/16" MS

PRIDE METAL PRODUCTS DIVISION
 13518 NE 258th Ct - RAIFORD, FL 32083
 PH: 813-890-6558 FAX: 813-890-2119

DATE	3/17/2017 10:28:39 AM	DATE	3/13/2017 8:46:41 AM	DESIGNER	MATHEWS
DESIGNED BY	ORRIN DAWG DOG WORLD/STAVITE	DESIGNED BY	MATHEWS		
SCALE	AS SHOWN	SCALE	AS SHOWN		
PROJECT	ORRIN DAWG DOG WORLD/STAVITE	PROJECT	MATHEWS		
PROJECT NO.	160969G	PROJECT NO.	160969G		
PROJECT NAME	PARK BENCH, STRAIGHT, SM, MS, 72"	PROJECT NAME	PARK BENCH, STRAIGHT, SM, MS, 72"		
PROJECT LOCATION		PROJECT LOCATION			
PROJECT DRAWN BY	ORRIN DAWG DOG WORLD/STAVITE	PROJECT DRAWN BY	MATHEWS		
PROJECT CHECKED BY		PROJECT CHECKED BY			
PROJECT APPROVED BY		PROJECT APPROVED BY			
PROJECT DATE	3/17/2017	PROJECT DATE	3/13/2017		
PROJECT TIME	10:28:39 AM	PROJECT TIME	8:46:41 AM		
PROJECT USER	ORRIN DAWG DOG WORLD/STAVITE	PROJECT USER	MATHEWS		
PROJECT PLOT		PROJECT PLOT			
PROJECT PLOT DATE		PROJECT PLOT DATE			
PROJECT PLOT TIME		PROJECT PLOT TIME			
PROJECT PLOT USER		PROJECT PLOT USER			
PROJECT PLOT DEVICE		PROJECT PLOT DEVICE			
PROJECT PLOT SCALE		PROJECT PLOT SCALE			
PROJECT PLOT SHEET		PROJECT PLOT SHEET			
PROJECT PLOT SHEET NO.		PROJECT PLOT SHEET NO.			
PROJECT PLOT SHEET TOTAL		PROJECT PLOT SHEET TOTAL			
PROJECT PLOT SHEET 1 OF 2		PROJECT PLOT SHEET 1 OF 2			
PROJECT PLOT SHEET 2 OF 2		PROJECT PLOT SHEET 2 OF 2			

± = HOLD DIMENSION

DEV

Sales Support Center
568 Northeast 255th Street
Cross City, Florida 32628



#160969G
813.890.2175 office
866.528.2175 fax
877.283.6819 toll free



PRIDE Enterprises
Sales Support Center and Bids
P.O. Box 440
Cross City, FL 32628

Contact: Jason Brown
Phone: (813) 890-6582
Fax: (727) 570-3449
E-Mail: bids@pride-enterprises.org
Web: www.pride-enterprises.org

Attachment "A-6"

Type III Shelter Bench Drawing

ZONE REV.	8	7	6	5	4	3	2	1
DESCRIPTION								
DATE								
DRAWN BY								
APPROVED BY								
ECN #								
								3/14/2017

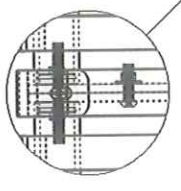
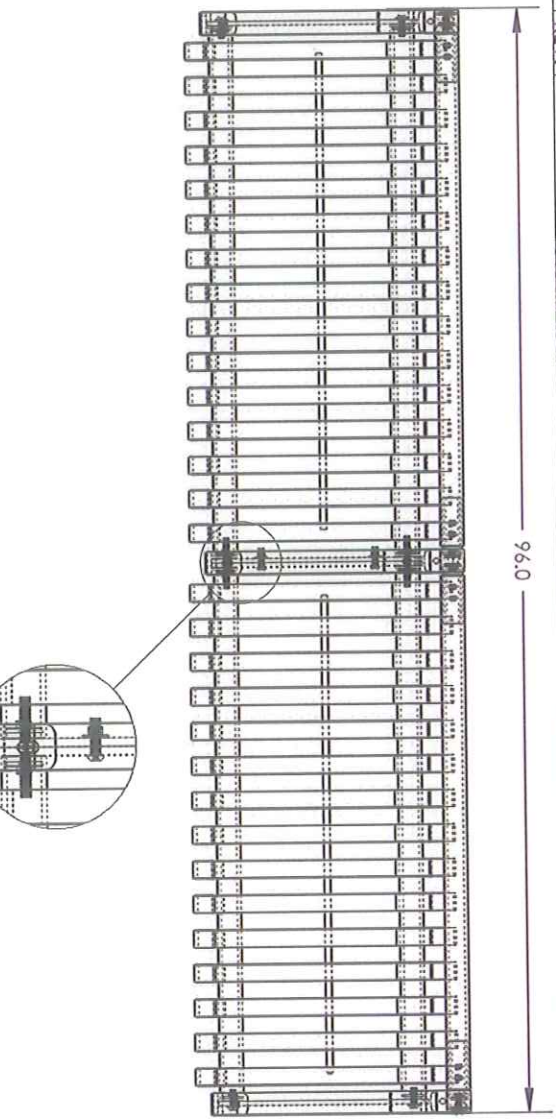

DETAIL A
SCALE 1 : 8

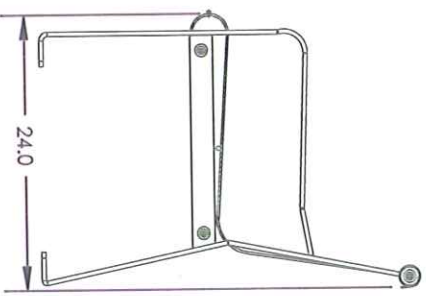
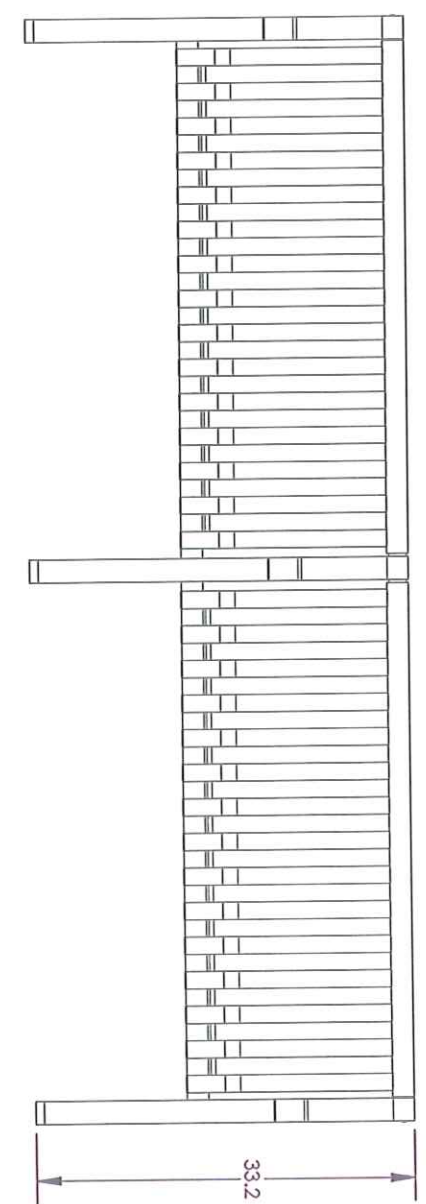
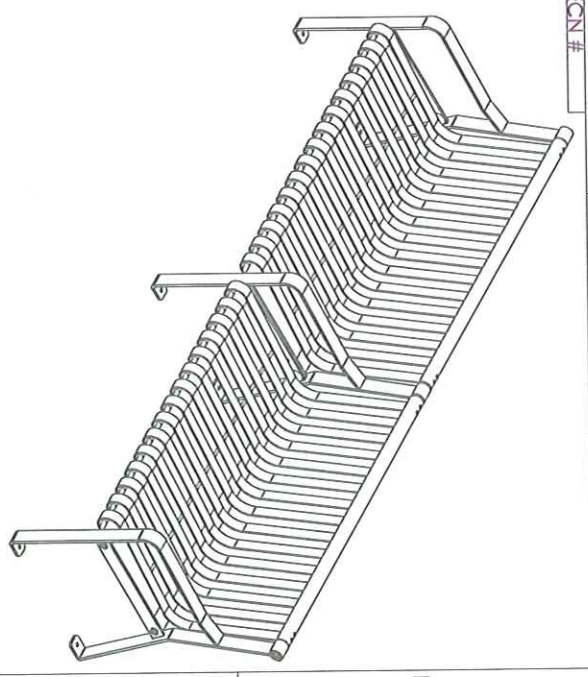

PRIDE METAL PRODUCTS DIVISION
 13519 NE 258th CT. - RAIFORD, FL 32083
 PH: 813-890-6556 FAX: 813-890-2119

DATE	9/13/2017 2:28:29 PM	DATE	3/13/2017 2:41:55 PM	DATE	3/3/2017 3:32:51 PM
DESCRIPTION	GENERATED DRAWING DO NOT MANUALLY UPDATE	DESCRIPTION	REWORK ALL DIMS & FIELD SHAPES	DESCRIPTION	REWORK ALL DIMS & FIELD SHAPES
SCALE	AS SHOWN	SCALE	AS SHOWN	SCALE	AS SHOWN
DESIGNER	VARIES	DESIGNER	VARIES	DESIGNER	VARIES
CHECKER	VARIES	CHECKER	VARIES	CHECKER	VARIES
DATE	86.707	DATE	86.707	DATE	86.707

PARK BENCH, STRAIGHT BACK, SM ALL
MS. SLATED, 8' WITH 3-LEGS
 41104040102-10
 SHEET 1 OF 1

DEV

Sales Support Center
568 Northeast 255th Street
Cross City, Florida 32628



#160969G
813.890.2175 office
866.528.2175 fax
877.283.6819 toll free



PRIDE Enterprises
Sales Support Center and Bids
P.O. Box 440
Cross City, FL 32628

For Delivery:
568 NE 255th Street; Cross City, FL 32628
Contact: Jason Brown
Phone: (813) 890-6582
Fax: (727) 570-3449
E-Mail: bids@pride-enterprises.org
Web: www.pride-enterprises.org

Attachment "B"

Warranty

Sales Support Center
568 Northeast 255th Street
Cross City, Florida 32628



#160969G
813.890.2175 office
866.528.2175 fax
877.283.6819 toll free



PRIDE Enterprises
Sales Support Center and Bids
P.O. Box 440
Cross City, FL 32628

Contact: Jason Brown
Phone: (813) 890-6582
Fax: (727) 570-3449
E-Mail: bids@pride-enterprises.org
Web: www.pride-enterprises.org

Product Warranty

PRIDE Enterprises Union Metal Industry warranties its Metal Products for (5) five years to be free of defects in materials and workmanship for the purposes intended, excluding normal wear and actions of abuse or misuse, such as vandalism, that are outside the control of Pride. Surface finishes are subject to Pride's evaluation. Pride will repair or replace parts or units at Pride's option.

Sales Support Center
568 Northeast 255th Street
Cross City, Florida 32628



#160969G
813.890.2175 office
866.528.2175 fax
877.283.6819 toll free



PRIDE Enterprises
Sales Support Center and Bids
P.O. Box 440
Cross City, FL 32628

For Delivery:
568 NE 255th Street; Cross City, FL 32628
Contact: Jason Brown
Phone: (813) 890-6582
Fax: (727) 570-3449
E-Mail: bids@pride-enterprises.org
Web: www.pride-enterprises.org

Attachment "C"

State Corporation Certification

State of Florida

Department of State

I certify from the records of this office that PRISON REHABILITATIVE INDUSTRIES AND DIVERSIFIED ENTERPRISES, INC. is a corporation organized under the laws of the State of Florida, filed on December 14, 1981.

The document number of this corporation is 761105.

I further certify that said corporation has paid all fees due this office through December 31, 2016, that its most recent annual report/uniform business report was filed on March 9, 2016, and that its status is active.

I further certify that said corporation has not filed Articles of Dissolution.

*Given under my hand and the
Great Seal of the State of Florida
at Tallahassee, the Capital, this
the Ninth day of March, 2016*



Ken DeFina
Secretary of State

Tracking Number: CC5393811182

To authenticate this certificate, visit the following site, enter this number, and then follow the instructions displayed.

<https://services.sunbiz.org/Filings/CertificateOfStatus/CertificateAuthentication>

Sales Support Center
568 Northeast 255th Street
Cross City, Florida 32628



#160969G

813.890.2175 office
866.528.2175 fax
877.283.6819 toll free



PRIDE Enterprises
Sales Support Center and Bids
P.O. Box 440
Cross City, FL 32628

For Delivery:
568 NE 255th Street; Cross City, FL
32628

Contact: Jason Brown
Phone: (813) 890-6582
Fax: (727) 570-3449
E-Mail: bids@pride-enterprises.org
Web: www.pride-enterprises.org

Attachment "D"

Company Profile



PRIDE Enterprises Company Profile

- ABOUT PRIDE ENTERPRISES** » Prison Rehabilitative Industries and Diversified Enterprises, Inc. (d/b/a PRIDE Enterprises) is a private, not-for-profit (501 (c) 3) corporation created by the Florida Legislature in 1981. PRIDE is a self-funded organization statutorily designated to operate Florida's prison industries. More than 3,000 unique products and services are produced and delivered by PRIDE's 41 diverse inmate work programs which are located in 21 Florida correctional facilities.
- ORGANIZATION** » The 11 members of the PRIDE Enterprises Board of Directors are appointed by the Governor and confirmed by the Senate. PRIDE has approximately 250 staff members and trains over 3,500 inmates annually. The company is comprised of 6 distinct business units: Agriculture, Sewn Products, Graphics/Digital, Services, General Manufacturing, and Specialty Manufacturing.
- COMMUNITY CONTRIBUTIONS** » PRIDE Enterprises trains inmates in real-world job skills in many diverse fields with a focus on external certifications such as: welding, forklift training, culinary, carpentry, dental and optical lab, engineering, customer service, and manufacturing. These programs, which include 400+ vocational job titles, have been developed to assist the offenders in their successful transition into the job market upon completion of their sentences. Re-entry programs lower the number of repeat offenders and reduce criminal justice costs for all citizens.
- PRIDE also serves the community through its statutory missions of serving the Department of Corrections' security goals by preventing inmate idleness; reducing the cost of state government; simulating a real-world working environment; and providing work training programs and post release job placement.
- MANUFACTURING CAPABILITIES & SERVICES** » **Products** Seating, Panel Systems, Office and Detention Furniture · Corrugated Boxes & Packaging Products · Indoor and Outdoor Signage · Bedding Products · Uniforms and Specialty Apparel · Footwear · Embroidery/Screen Printing · Traffic Paint · Lumber and Outdoor Furniture Products · Metal Products · Janitorial Products and Services · Specialty & Custom Products · Warehousing · Graphics/Printing · Agriculture · Meat Processing.
- Services** Digital Imaging/Storage · Mailing · Optical Lab · Dental Lab · Tire Retread · Heavy Vehicle Conversions, Repair & Renovation.
- VALUE ADDED SERVICES** » **Contract Manufacturing** Product/Process Engineering · Manufacturing Expertise · Contract Management · Marketing & Message Communication · Digital Asset Management
- Product Expert Professionals** Technologically Knowledgeable · Quality Driven · ISO 9000 Certified
- Centralized Customer Service** Local Service Representatives · Web-based Purchasing · Industry-specific expertise · Customer-friendly website
- Partnerships** Strategic Relationships · Innovative Solutions
- QUALIFICATIONS** » **Qualifications** 35 years of manufacturing experience · Annual sales in excess of \$75 million · Demonstrated ability to handle complex large volume orders while able to devote time to small custom jobs · On-site customer service · Professional staff includes engineers, designers, IT professionals, manufacturing experts and technical specialists.



Outdoor Products

PARK FURNITURE, FENCING, LUMBER, AND MORE

PRIDE is a self-funded enterprise whose mission makes a positive difference in Florida. We make communities safer and save taxpayers money by training eligible inmates in vocational skills and transitioning them into the job market upon completion of their sentences.

PRISON REHABILITATIVE INDUSTRIES AND DIVERSIFIED ENTERPRISES, INC., doing business as PRIDE Enterprises, is a nationally recognized inmate training company operating general manufacturing and services facilities throughout the state of Florida. PRIDE offers more than 400 vocational training courses through its 41 diverse inmate work programs with assigned inmates from 21 Florida correctional institutions.

A private, not-for-profit corporation founded in 1981, PRIDE has experience and expertise working in correctional environments. In addition to vocational work programs that teach job skills and successful job behaviors to inmate workers, PRIDE's inmate transition services include employability skills training, job placement, and other basic support services that prepare and assist ex-offenders in their successful reintegration into society.

35 COLOR & MOUNTING OPTIONS

40 WARRANTY INFORMATION

42 PRODUCTS + SERVICES



Tables
4



Benches
8



Receptacles
11



Fire Rings/Grills
8



Miscellaneous
22



Signs/Kiosks
26



Fencing/Barriers
28

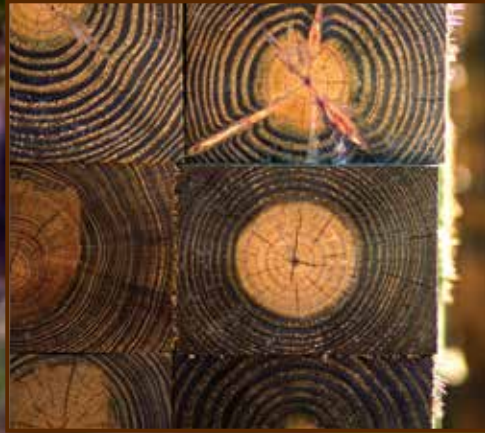

Lumber
36



Stackable Wood Picnic Table, Shown on Page 5

Picnic

The classic picnic table, constructed with quality #1 grade Southern Yellow Pine lumber, is attractive, durable and low-maintenance.

Standard Wood Picnic Tables

The rugged construction of our standard picnic tables is ideal for high-use outdoor picnic areas.

Item	Product ID	Dimensions
6' Standard Picnic Table	14167200NA	60"W x 30"H x 6'L
8' Standard Picnic Table	14167202NA	60"W x 30"H x 8'L
6' Standard ADA Picnic Table	14167201NA	60"W x 30"H x 8'L
8' Standard ADA Picnic Table	14167203NA	60"W x 30"H x 10'L



Stackable Wood Picnic Tables

Perfect for the always changing environment, our stacking picnic tables are portable and easy to store.

Item	Product ID	Dimensions
6' Stackable Picnic Table	14167204NA	60"W x 30"H x 6'L
8' Stackable Picnic Table	14167206NA	60"W x 30"H x 8'L
6' Stackable ADA Picnic Table	14167205NA	60"W x 30"H x 8'L
8' Stackable ADA Picnic Table	14167207NA	60"W x 30"H x 10'L



Specialty Wood Picnic Tables

Looking for a heavy-duty table or the perfect size for the playground? Check out our specialty picnic tables.

Item	Product ID	Dimensions
4' Children's Picnic Table	14167208NA	60"W x 27"H x 4'L
4' Adult Picnic Table	14167209NA	62"W x 31"H x 4'L
8' Heavy-Duty Picnic Table	14167210NA	60"W x 27"H x 4'L



Easy-Access

Easy-access tables offer a walkthrough design using a single-welded metal frame that also provides easy portability.

Square Easy-Access Wood Tables

The square, easy-access wood table is ideal for break and lunch areas with limited space.

Item	Product ID	Dimensions
36" Square Easy-Access Wood Table	14167410NA	64"W x 30"H x 64"L
36" Square Easy-Access Wood Table ADA	14167411NA	51"W x 30"H x 36"L



#160969G

Square Easy-Access Plastic Tables

A green-alternative, the square easy-access table is available in cedar or sand-colored recycled plastic.

Item	Product ID	Dimensions
36" Square Easy-Access Plastic Table	14167410PLA	64" w x 30" h x 64" l
36" Square Easy-Access Plastic ADA Table	14167411PLA	51" w x 30" h x 36" l



Round Easy-Access Metal Tables

Great for the tightest spaces, the round, easy-access metal table is available in the powder-coat, galvanized, or Plascoat™ color of your choosing. Metal tables are available with punched or lasered patterns. Cool off by adding an umbrella in the provided mount.

Item	Product ID	Dimensions
45" Round Easy-Access Metal Table	97503	80" w x 30" h x 80" l
Round Easy-Access Metal Table	90386	80" w x 30" h x 80" l
Round Easy-Access Metal ADA Table	90387	80" w x 30" h x 80" l



Square Easy-Access Metal Tables

Great for the tightest spaces, the round, easy-access metal table is available in the powder-coat, galvanized, or Plascoat™ color of your choosing. Metal tables are available with punched or lasered patterns. Cool off by adding an umbrella in the provided mount.

Item	Product ID	Dimensions
Square Easy-Access Metal Table	90384	64" w x 30" h x 64" l
Square Easy-Access Metal ADA Table	90385	54" w x 30" h x 36" l



Easy-Access Metal Tables

Built to withstand all conditions, the easy-access metal table is available in the powder-coat, galvanized, or Plascoat™ color of your choosing. Metal tables are available with punched or lasered patterns.

Item	Product ID	Dimensions
6' Easy-Access Metal Table	97009	54" w x 30" h x 6' l
8' Easy-Access Metal Table	97008	54" w x 30" h x 8' l
6' Easy-Access Metal Table	90380	54" w x 30" h x 6' l
8' Easy-Access Metal Table	90382	54" w x 30" h x 8' l
6' Easy-Access Metal ADA Table	90381	54" w x 30" h x 6' l
8' Easy-Access Metal ADA Table	90383	54" w x 30" h x 8' l



Easy-Access Wood Tables

Easy-access wood tables offer strength and durability in all seasons.

Item	Product ID	Dimensions
6' Easy-Access Wood Table	14167300NA	60" w x 30" h x 6' L
8' Easy-Access Wood Table	14167302NA	60" w x 30" h x 8' L
6' Easy-Access Wood ADA Table	14167301NA	60" w x 30" h x 8' L
8' Easy-Access Wood ADA Table	14167303NA	60" w x 30" h x 10' L



Easy-Access Plastic Tables

A green-alternative, easy-access tables are available in cedar or sand-colored recycled plastic.

Item	Product ID	Dimensions
6' Easy-Access Plastic Table	14167300PLA	60" w x 30" h x 6' L
8' Easy-Access Plastic Table	14167302PLA	60" w x 30" h x 8' L
6' Easy-Access Plastic ADA Table	14167301PLA	60" w x 30" h x 8' L
8' Easy-Access Plastic ADA Table	14167303PLA	60" w x 30" h x 10' L



Pedestal

Pedestal tables are the easy choice for open public areas where security is paramount—also providing durability and longevity.

Landscape Timber Freestanding Table

Constructed with pressure-treated Southern Yellow Pine, the Landscape Timber Freestanding Table gives a natural outdoor look and is perfect for hosting large crowds.

Item	Product ID	Dimensions
6' Landscape Timber Freestanding Table	14167810NA	32.5" w x 31" h x 6' L



Metal Double-Pedestal Tables

Double-metal pedestal tables provide more seating space and the security you need. Available in the powder-coat, galvanized, or Plascoat™ color of your choosing. Metal tables are available with punched or lasered patterns.

Item	Product ID	Dimensions
6' Metal Double-Pedestal Table, In-Ground Mounted	97039	67" w x 30" h x 6' L
8' Metal Double-Pedestal Table, Surface-Mounted	97018	67" w x 30" h x 8' L

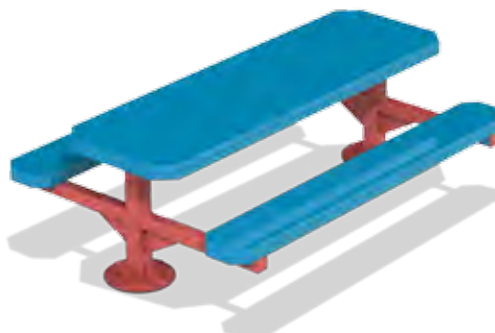

Benches



Classic

Classic benches are attractive, long-lasting, and practical for everyday use, providing years of maintenance-free public seating.

Classic Wood Benches

Classic wood benches add a distinguished look to its surroundings. Also available without arms.

Item	Product ID	Dimensions
6' Classic Freestanding Wood Bench	14167501NA	25"w x 36"h x 6'l
8' Classic Freestanding Wood Bench	14167502NA	25"w x 36"h x 8'l
6' Classic Wood Bench, In-Ground Mounted	14167601NA	25"w x 73"h x 6'l
8' Classic Wood Bench, In-Ground Mounted	14167602NA	25"w x 73"h x 8'l



Classic Plastic Benches

Classic plastic benches are an ideal substitute for any environment-friendly setting. Also available without arms and in cedar or sand-colored recycled plastic.

Item	Product ID	Dimensions
6' Classic Freestanding Plastic Bench	14167501PLA	25"w x 36"h x 6'l
8' Classic Freestanding Plastic Bench	14167502PLA	25"w x 36"h x 8'l
6' Classic Plastic Bench, In-Ground Mounted	14167601PLA	25"w x 73"h x 6'l
8' Classic Plastic Bench, In-Ground Mounted	14167602PLA	25"w x 73"h x 8'l



Classic Metal Benches

Classic metal benches are built for strength and stability in ever-changing seasons and are available in the powder-coat, galvanized, or Plascoat™ color of your choosing. Available with punched or lasered patterns.

Item	Product ID	Dimensions
6' Classic Freestanding Metal Bench	97307B	23"w x 37"h x 6'l
8' Classic Freestanding Metal Bench	90369	23"w x 37"h x 8'l
6' Classic Metal Bench, In-Ground Mounted	97306B	23"w x 37"h x 6'l
8' Classic Metal Bench, In-Ground Mounted	90368	23"w x 37"h x 8'l



Contour

Whether you seek a seat for a quick or leisurely rest, the contour bench combines quality and simple comfort in a easy-to-use design.

Wood Contour Benches

The ruggedly constructed wood contour benches are attractive and provide long-lasting comfort.

Item	Product ID	Dimensions
6' Wood Contour Bench, In-Ground Mounted	14167701NA	20"w x 53"H x 6'L
8' Wood Contour Bench, In-Ground Mounted	14167702NA	20"w x 53"H x 8'L
6' Wood Contour Bench, Surface-Mounted	14167704NA	20"w x 35"H x 6'L
8' Wood Contour Bench, Surface-Mounted	14167705NA	20"w x 35"H x 8'L



Plastic Contour Benches

Plastic contour wood benches are the perfect eco-friendly seating selection for extensive sitting. Available in cedar or sand-colored recycled plastic.

Item	Product ID	Dimensions
6' Plastic Contour Bench, In-Ground Mounted	14167701PLA	20"w x 53"H x 6'L
8' Plastic Contour Bench, In-Ground Mounted	14167702PLA	20"w x 53"H x 8'L
6' Plastic Contour Bench, Surface-Mounted	14167704PLA	20"w x 35"H x 6'L
8' Plastic Contour Bench, Surface-Mounted	14167705PLA	20"w x 35"H x 8'L



Metal Contour Benches

Merging comfort and style, the metal contour benches are available in the powder-coat, galvanized, or Plascoat™ color of your choosing. Available with punched or lasered patterns.

Item	Product ID	Dimensions
6' Metal Contour Bench, Surface-Mounted	97305B	23"w x 37"H x 6'L
8' Metal Contour Bench, Surface-Mounted	90367	28"w x 37"H x 8'L
6' Metal Contour Bench, In-Ground Mounted	97304B	23"w x 37"H x 6'L
8' Metal Contour Bench, In-Ground Mounted	90366	28"w x 37"H x 8'L



Trailside

Perfect for parks, playgrounds, schools and any environment where short-term seating is what you seek, the trailside bench selection has what you need.

Covered Single-Trailside Benches

The covered single-trailside bench is perfect for finding refuge from the elements and provide maintenance-free trailside seating. Forest green metal roof is standard.

Item	Product ID	Dimensions
6' Covered Single-Trailside Bench	14167011NA	8'w x 8'h x 14'l



Landscape Timber Trailside Benches

The all-wood landscape timber trailside benches are great for adding a natural touch to any location. Also available with back.

Item	Product ID	Dimensions
6' Landscape Timber Trailside Bench	14167506NA	20.5"w x 21"h x 6'l
8' Landscape Timber Trailside Bench	14167507NA	20.5"w x 21"h x 8'l



Landscape Timber Trailside Benches

The all-wood landscape timber trailside benches are great for adding a natural touch to any location. Also available without back.

Item	Product ID	Dimensions
6' Landscape Timber Trailside Bench With Back	14167806NA	25.5"w x 21.5"h x 6'l
8' Landscape Timber Trailside Bench With Back	14167807NA	28.5"w x 40"h x 8'l



Rustic Wood Benches

The all-wood Rustic benches are constructed with Southern Yellow Pine and are great for adding a natural touch to any location.

Item	Product ID	Dimensions
6' Rustic Wood Bench, In-Ground Mounted	14167811NA	24.5"w x 41.5"h x 6'l



Wood Trailside Benches

Wood trailside benches are comfortable and blend easily with all natural atmospheres.

Item	Product ID	Dimensions
6' Wood Trailside Bench, Surface-Mounted	14167804NA	14"W x 36"H x 6'L
8' Wood Trailside Bench, Surface-Mounted	14167805NA	14"W x 36"H x 8'L
6' Wood Trailside ADA Bench, In-Ground Mounted	141678891NA	25"W x 55"H x 6'L
6' Wood Trailside Bench, In-Ground Mounted	14167801NA	14"W x 18"H x 6'L
8' Wood Trailside Bench, In-Ground Mounted	14167802NA	14"W x 18"H x 8'L
6' Wood Trailside ADA Bench, Surface-Mounted	141678889NA	25"W x 37"H x 6'L



Plastic Trailside Benches

Plastic trailside benches are a great alternative for the environmentally conscious.

Item	Product ID	Dimensions
6' Plastic Trailside Bench, Surface-Mounted	14167804PLA	14"W x 36"H x 6'L
8' Plastic Trailside Bench, Surface-Mounted	14167805PLA	14"W x 36"H x 8'L
6' Plastic Trailside Bench, In-Ground Mounted	14167801PLA	14"W x 36"H x 6'L
8' Plastic Trailside Bench, In-Ground Mounted	14167802PLA	14"W x 36"H x 8'L



Metal Trailside Benches

Metal trailside benches are made with metal planks. The benches are finished in the powder-coat, galvanized, or Plascoat™ color of your choosing. Available with punched or lasered patterns.

Item	Product ID	Dimensions
6' Metal Trailside Bench, Surface-Mounted	97309B	14"W x 36"H x 6'L
8' Metal Trailside Bench, Surface-Mounted	90379	14"W x 36"H x 8'L
6' Metal Trailside Bench, In-Ground Mounted	97308B	14"W x 36"H x 6'L
8' Metal Trailside Bench, In-Ground Mounted	90378	14"W x 36"H x 8'L



Transit

The transit bench is handicap accessible and manufactured with durable and lightweight recycled plastic.

Transit Bench

Wait in style with the plastic ADA transit bench. Available in cedar-colored recycled plastic.

Item	Product ID	Dimensions
6' Plastic ADA Transit Bench, Surface-Mounted	14167704PSTA	24"W x 31"H x 6'L





LOOK FOR
Kiosks
ON PAGE 26



Classic Wood Trash Receptacle, Shown on Page 15

Receptacles

Allow PRIDE to provide a pleasing solution to your containment needs with our complete line of trash receptacles and animal-resistant containers.

Classic Wood Trash Receptacles

Hide unsightly trash cans with the naturally attractive wood trash can receptacles.

Item	Product ID	Dimensions
20 Gallon Classic Wood Trash Receptacle Holder	14167900NA	23.5"w x 25.5"h
32 Gallon Classic Wood Trash Receptacle Holder	14167901NA	27.75"w x 32"h



Classic Heavy-Duty Wood Trash Receptacles

The heavy-duty wood trash receptacles offer additional capacity and strength for trash can storage.

Item	Product ID	Dimensions
20 Gallon Heavy-Duty Wood Trash Receptacle Holder	14167902NA	23.5"w x 25.5"h
32 Gallon Heavy-Duty Wood Trash Receptacle Holder	14167903NA	27.75"w x 32"h
55 Gallon Heavy-Duty Wood Trash Receptacle Holder	14167904NA	32.5"w x 38"h

Classic Plastic Trash Receptacles

Keep the environment and grounds clean with plastic trash can receptacles.

Item	Product ID	Dimensions
20 Gallon Plastic Trash Receptacle Holder	14167902PLA	23.5"w x 25.5"h
32 Gallon Plastic Trash Receptacle Holder	14167903PLA	27.75"w x 32"h



Classic Heavy-Duty Plastic Trash Receptacles

With more storage capacity, the heavy duty plastic trash receptacles are great for keeping a clean environment.

Item	Product ID	Dimensions
55 Gallon Heavy-Duty Plastic Trash Receptacle Holder	14167904PLA	30.37"w x 38"h
44 Gallon Heavy-Duty Plastic Trash Receptacle Holder	14167911PLA	30"w x 32"h

Covered Square Wood Trash Receptacle

The covered, square, wood trash receptacle is durable and provides two deposit slots for easy trash disposal.

Item	Product ID	Dimensions
32 Gallon Covered Square Wood Trash Receptacle	14167906NA	28"w x 38"H



Square Wood Trash Receptacle

The square wood trash receptacle provides strength and security with a 1/2" plywood hinged lid and attached handle.

Item	Product ID	Dimensions
32 Gallon Square Wood Trash Receptacle	14167905NA	28"w x 32"H



Metal Slotted Trash Receptacle

The metal slotted trash receptacle provides a unique style for your trash can storage and is available in the powder-coat or Plascoat™ color of your choosing.

Item	Product ID	Dimensions
32 Gallon Metal Slotted Trash Receptacle, Single Door	98581C	32"w x 44"H x 32"L
32 Gallon Metal Slotted Trash Receptacle, Double Door	95768A	32"w x 44"H x 32"L



Metal Slotted Trash Receptacle

The metal slotted trash receptacle provides a unique style for your trash can storage and is available in the powder-coat or Plascoat™ color of your choosing.

Item	Product ID	Dimensions
32 Gallon Metal Slotted Trash Receptacle, Two Cans	91910	61"w x 34"H x 31"L



Decorative Trash Receptacle

Decorative trash receptacles are well-built and attractive and are available in the powder-coat or Plascoat™ color of your choosing.

Item	Product ID	Dimensions
32 Gallon Decorative Trash Receptacle	98936	25"w x 36"h



Mailbox-Style Animal-Resistant Single Bin Trash Receptacle

Mailbox-style trash receptacles offer security and convenience for your of trash disposal needs and is available in the powder-coat or Plascoat™ color of your choosing.

Item	Product ID	Dimensions
Mailbox-Style Animal-Resistant Single Bin Trash Receptacle	98319B	24"w x 54"h x 24"L



Animal-Resistant Single Bin Trash Receptacles

With padlock capabilities, the animal-resistant trash receptacles offer protection from animals of all kinds. Can be connected in series to meet your needs and is available in the powder-coat or Plascoat™ color of your choosing.

Item	Product ID	Dimensions
32 Gallon Single Bin Animal-Resistant Trash Receptacle	98477A	29"w x 55"h x 55"L



Bear-Proof Food Storage Bin

Store food and beverages in bear-proof container designed to hold the standard cooler and is available in the powder-coat or Plascoat™ color of your choosing.

Item	Product ID	Dimensions
Bear-Proof Food Storage Bin	91550	48"w x 43"h x 31"L



#160969G



Grills/Fire Rings

Double Grill, Shown on Page 20

Fire Rings

PRIDE fire rings are constructed of low-maintenance steel, are accessible from all sides, and have an adjustable grill plate for easy heat control. Fire rings can be mounted in-ground or surface-mount.

Contact us for a full listing of fire rings.

Single Fire Rings

Employing a hinged grill plate, the stationary single fire rings are designed with safety in mind.

Item	Product ID	Dimensions
Single Standard Fire Ring	15821	32"w x 7"H x 32"L

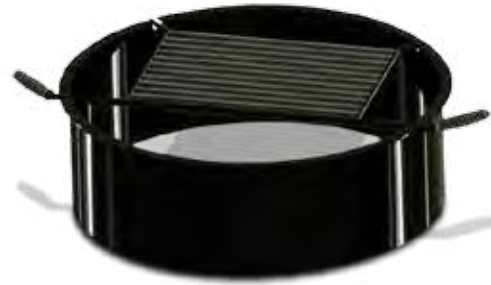

Double Fire Rings

With multiple positions for grill placement the double fire ring provides ideal cooking temperatures.

Item	Product ID	Dimensions
Double Standard Fire Ring	97834ACV	32"w x 17"H x 32"L



Adjustable Fire Rings

Adjustable fire rings have a removable grill plate for easy coal replacement.

Item	Product ID	Dimensions
Adjustable Fire Ring	15822	32"w x 17"H x 32"L

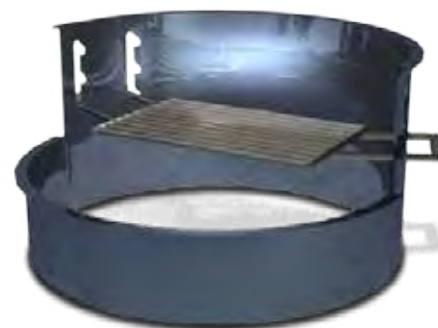

Grills

Available with an adjustable standard or laser grill plate, PRIDE grills are constructed of low-maintenance steel and offer a 360° swivel for ease-of-use. Contact us for a full listing of grills.

STANDARD FEATURES Construction: Cold Rolled Steel | Mounting: Surface-Mount or In-Ground | Single Grill/ Pedestal Designs Standard with Pivoting Fire Box

ACCESSORIES Side Table | Full Grill or Griddle Flip Top Hood (Selected Models Only)

Grillmaster Single Grills

Perfect for any outdoor setting, the single grill can be mounted in the tightest of spaces.

Item	Product ID	Dimensions
Single Standard Grill, In-Ground Mounted	71030CV	20.5"w x 61"H x 15"L
Single Standard Grill, Griddle, Surface-Mounted	71200CV	20.5"w x 38"H x 15"L



Grillmaster Double Grills

The double grill provides twice the size and function of a single grill while still using minimal space.

Item	Product ID	Dimensions
Double Standard Grill, Griddle, In-Ground Mounted	15823	32"w x 61"H x 32"L
Double Standard Grill, In-Ground Mounted	72200CV	32"w x 38"H x 32"L



LOOK FOR
Fencing
ON PAGE 28

Miscellaneous



Bike Racks

Bikes are a healthy means of transportation, but storing bikes safely can be difficult. PRIDE bike racks can provide an attractive solution.

Serpentine Bike Racks

Serpentine series is great for securing few or many bicycles in outdoor spaces. Bike rack mounting is designed for either a surface-mount or in-ground and is available in the powder-coat, galvanized, or Plascoat™ color of your choosing.

Item	Product ID	Dimensions
1-Hump Serpentine Bike Rack, Surface-Mounted	98353C	18"w x 36"h x 6"d
2-Hump Serpentine Bike Rack, Surface-Mounted	98354C	43"w x 36"h x 6"d
3-Hump Serpentine Bike Rack, Surface-Mounted	98426C	66"w x 36"h x 6"d
4-Hump Serpentine Bike Rack, Surface-Mounted	90292	93"w x 36"h x 6"d
5-Hump Serpentine Bike Rack, Surface-Mounted	98484C	118"w x 36"h x 6"d
1-Hump Serpentine Bike Rack, In-Ground Mounted	98482C	18"w x 46"h x 2.5"d
2-Hump Serpentine Bike Rack, In-Ground Mounted	98380C	43"w x 46"h x 2.5"d
3-Hump Serpentine Bike Rack, In-Ground Mounted	98217C	66"w x 46"h x 2.5"d
4-Hump Serpentine Bike Rack, In-Ground Mounted	98382C	93"w x 46"h x 2.5"d
5-Hump Serpentine Bike Rack, In-Ground Mounted	98485C	118"w x 46"h x 2.5"d

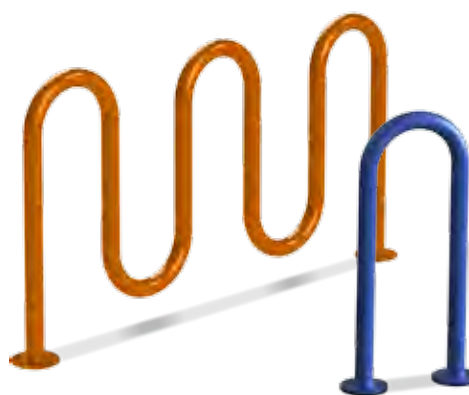

Logo Series Bike Racks

The Logo series bike racks have a laser cut image designed to the customers need. Bike rack mounting is designed for either a surface-mount or in-ground and is available in the powder-coat, galvanized, or Plascoat™ color of your choosing.

Item	Product ID	Dimensions
Logo Series Bike Rack, Surface-Mounted	98456C	35"w x 36"h x 6"d
Logo Series Bike Rack, In-Ground Mounted	90364	35"w x 46"h x 2.5"d



St. Louis Bike Rack

With a unique design, the St. Louis bike racks are ideal when seeking simplicity and efficiency. Bike rack mounting is designed for either a surface-mount or in-ground and is available in the powder-coat, galvanized, or Plascoat™ color of your choosing.

Item	Product ID	Dimensions
St. Louis Bike Rack, Surface-Mounted	98552C	35"w x 31.5"h x 5.5"d
St. Louis Bike Rack, In-Ground Mounted	98805C	35"w x 42"h x 2.5"d



U Rack Bike Rack

The U Rack series bike rack is designed to withstand tough conditions in any environment. Bike rack mounting is designed for either a surface-mount or in-ground and is available in the powder-coat, galvanized, or Plascoat™ color of your choosing.

Item	Product ID	Dimensions
U Rack Bike Rack, Surface-Mounted	98453C	35"w x 36"h x 5.5"d
U Rack Bike Rack, In-Ground Mounted	98839C	35"w x 46"h x 2.5"d



Hitch Bike Racks

Hitch series is great for securing few bicycles in small spaces. Bike rack mounting is designed for either a surface-mount or in-ground and is available in the powder-coat, galvanized, or Plascoat™ color of your choosing.

Item	Product ID	Dimensions
Hitch Bike Rack, Surface-Mounted	98606C	18"w x 36"h x 5.5"d
Hitch Bike Rack, In-Ground Mounted	98607C	18"w x 46"h x 5.5"d



Security Boxes

The collection of public funds is no easy task. Securing those funds is even harder. Let PRIDE facilitate that function with our security boxes.

Iron Ranger Fee Box

The Iron Ranger fee box is the ideal setup to collect fees outside of business hours. The Iron Ranger fee box mounting is designed for either a surface-mount or in-ground and is available in the powder-coat, galvanized, or Plascoat™ color of your choosing. Iron ranger money box sold separately.

Item	Product ID	Dimensions
Iron Ranger Fee Box In-Ground Mounted	96237	16"w x 60"H x 11"L
Iron Ranger Fee Box Surface-Mounted	96265	16"w x 48"H x 11"L

Iron Ranger Money Box

Used as a part of the Iron Ranger fee box setup or separately for small jobs. The money box is available in the powder-coat, galvanized, or Plascoat™ color of your choosing.

Item	Product ID	Dimensions
Money Box	98349A	6.25"w x 16"H x 15.25"L



Lantern Holders

Light the way with our selection of lantern holders. All constructed from hot-dipped galvanized steel, these lantern holders are available in a variety of setups.

Lantern Holders

Our lantern holders come in many styles and are available in the powder-coat or Plascoat™ color of your choosing.

Item	Product ID	Dimensions
Single Standard Reverse L Lantern Holder	98868A	2"w x 14"H x 104"L
Single Standard Reverse Curved L Lantern Holder	98225B	2"w x 14"H x 111"L
Double Standard Curved-T Lantern Holder	98224B	2"w x 26"H x 111"L
ADA Attachment with Hook	98224B	3"w x 4"H x 10"L
Shelf Attachment	98279B	14"w x 1"H x 20"L

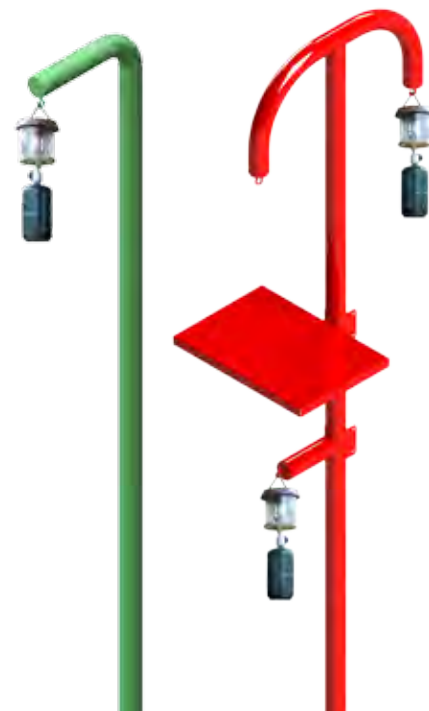



Kiosks

Constructed with durable Southern Yellow Pine, our kiosks protect information in any location.

Standard Kiosks

Standard kiosks are ruggedly constructed to protect your information from the outside elements.

Item	Product ID	Dimensions
7' Standard Single-Sided Kiosk, 3' x 5' Info Board	1416735SGL	6'w x 16'h x 7'l
9' Standard Single-Sided Kiosk, 4' x 6' Info Board	1416746SGL	7'w x 16'h x 9'l
7' Standard Double-Sided Kiosk, 3' x 5' Info Board	1416735DBL	6'w x 16'h x 7'l
9' Standard Double-Sided Kiosk, 4' x 6' Info Board	1416746DBL	7'w x 16'h x 9'l



Small Kiosk

Small kiosks are great for tight spaces while still providing necessary protection.

Item	Product ID	Dimensions
6' Small Kiosk	1416733SGL	5'w x 16'h x 6'l



Signs

PRIDE signs can provide wayfinding information or inform the public of items of importance.

Trailside Sign

Trailside signs are ideal for providing direction or protecting important information.

Item	Product ID	Dimensions
12' Trailside Sign	14167003	4'w x 12'h x 12'l



Fencing/Barriers



Fencing Systems

Constructed with Southern Yellow Pine, PRIDE fencing systems are useful for controlling traffic and clearly defining areas whether they be recreational or professional.

Mortise Fencing System

Item	Product ID	Dimensions
Mortise Rail	1416151908NA	6"W x 2"H x 8'L
Mortise Rail	1416151910NA	6"W x 2"H x 10'L
Mortise Line Post, 1-slot	1416151202ALS1	6"W x 4"H x 6'L
Mortise End Post, 1-slot	1416151202AES1	6"W x 4"H x 6'L
Mortise Corner Post, 1-slot	1416151402ACS1	6"W x 6"H x 6'L
Mortise Line Post, 2-slot	1416151202ALS2	6"W x 4"H x 6'L
Mortise End Post, 2-slot	1416151202AES2	6"W x 4"H x 6'L
Mortise Corner Post, 2-slot	1416151402ACS2	6"W x 6"H x 6'L
Mortise Line Post, 3-slot	1416151202ALS3	6"W x 4"H x 7'L
Mortise End Post, 3-slot	1416151202AES3	6"W x 4"H x 7'L
Mortise Corner Post, 3-slot	1416151402ACS3	6"W x 6"H x 7'L

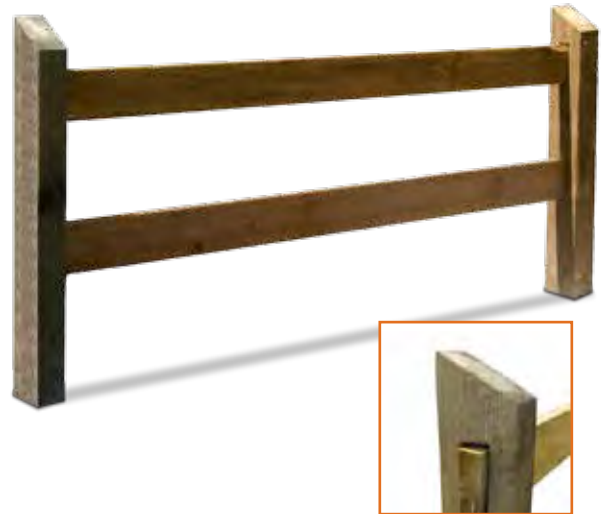

Split Rail Fencing System

Item	Product ID	Dimensions
Split Rail	1416151904NA	4"W x 3"H x 8'L
Split Rail	1416151905NA	4"W x 3"H x 11'L
Split Rail Line Post, 1-slot	1416151910NA	5-6"D x 6.5'L
Split Rail Line Post, 2-slot	1416151909NA	5-6"D x 6.5'L
Split Rail Line Post, 3-slot	1416151911NA	5-6"D x 7'L



Diamond Rail Fencing System

Item	Product ID	Dimensions
Diamond Rail	1416151082NA	3.5"W x 3.5"H x 8'L
Diamond Rail	1416151102NA	3.5"W x 3.5"H x 10'L
Diamond Line Post, 1-slot	141615701NA	5.5"W x 5.5"H x 6'L
Diamond Line Post, 2-slot	141615702NA	5.5"W x 5.5"H x 6'L



Dowel Fencing System

Item	Product ID	Dimensions
Dowel Rail	1416155204DA	3-4"D x 8'L
Dowel Line Post, 1-slot	14161554025DLA1	5-6"D x 6.5'L
Dowel End Post, 1-slot	14161554025DEA1	5-6"D x 6.5'L
Dowel Corner Post, 1-slot	1416151702DCA1	5-6"D x 8'L
Dowel Line Post, 2-slot	14161554025DLA2	5-6"D x 6.5'L
Dowel End Post, 2-slot	14161554025DEA2	5-6"D x 6.5'L
Dowel Corner Post, 2-slot	1416151702DCA2	5-6"D x 8'L
Dowel Line Post, 3-slot	14161554025DLA3	5-6"D x 7'L
Dowel End Post, 3-slot	14161554025DEA3	5-6"D x 7'L
Dowel Corner Post, 3-slot	1416151702DCA3	5-6"D x 8'L



Martin-Style Fencing System

Item	Product ID	Dimensions
Martin-Style Rail	14163020808NA	2"W x 8"H x 8'L
Martin-Style Line Post	14163060605NA	6"W x 6"H x 5'L

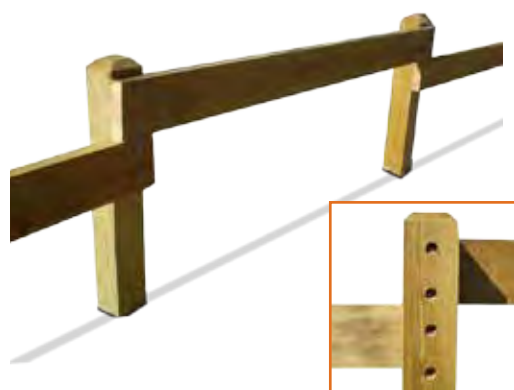

St. Lucie-Style Fencing System

Item	Product ID	Dimensions
St. Lucie-Style Diamond Rail	1416151082NA	4"W x 4"H x 8'L
St. Lucie-Style Diamond Rail	1416151102NA	4"W x 4"H x 10'L
St. Lucie-Style 2-Rail Line Post	14162080806STL	8"W x 8"H x 6'L
St. Lucie-Style 2-Rail End Post	14162080806STL2	8"W x 8"H x 6'L
St. Lucie-Style 2-Rail Corner Post	14162080806STL3	8"W x 8"H x 6'L
St. Lucie-Style 3-Rail Line Post	14162080806STL4	8"W x 8"H x 7'L
St. Lucie-Style 3-Rail End Post	14162080806STL5	8"W x 8"H x 7'L
St. Lucie-Style 3-Rail Corner Post	14162080806STL6	8"W x 8"H x 7'L



Agricultural Fencing System

Item	Product ID	Dimensions
Square Fence Post	14162040407NA	4"W x 4"H x 7'L
Square Fence Post	14162040408NA	4"W x 4"H x 8'L
Square Fence Post	14162060608NA	6"W x 6"H x 8'L
Square Gate Post	14162060610NA	6"W x 6"H x 10'L
Square Fence Rail	14162010616NA	6"W x 1"H x 16'L



D.O.T. Approved Materials

#160969G

All D.O.T. Approved Materials are milled, graded, and treated according to Federal and State Department of Transportation guidelines and specifications.

Guardrail Posts

Item	Product ID	Dimensions
Standard D.O.T. Guardrail Post	1416453601	5.5"w x 7.25"h x 6.5'l
Standard Breakaway Guardrail Post	1416453201	5.5"w x 7.25"h x 42.5'l
Standard CRT Guardrail Post	1416463211	5.5"w x 7.25"h x 6'l
Standard Slotted Breakaway Guardrail Post	1416453213	5.5"w x 7.25"h x 42.5'l



Guardrail Blocks

Item	Product ID	Dimensions
Standard D.O.T. Wide Guardrail Block	1416401	6"w x 12"h x 14'l
Standard D.O.T. Wide Guardrail Block	1416405	6"w x 14"h x 14'l
D.O.T. Tribeam Guardrail Block	1416406	6"w x 8"h x 22'l
Radial Wing, Wedge Guardrail Block	1415453203	6"w x 13.5"h x 2.5'l
Straight Wing, Wedge Guardrail Block	1415453205	6"w x 13.5"h x 5'l
Standard D.O.T. 2-hole Offset Guardrail Block	1416453500	6"w x 8"h x 14'l
Standard D.O.T. 1-hole Offset Guardrail Block	1416453501	6"w x 8"h x 14'l



Type-A Right-of-Way Fence Posts

Item	Product ID	Dimensions
D.O.T. Fence Post CCA	1416155304	4-5" w x 8" h
D.O.T. Fence Post CCA	1416155045	5-6" w x 8'6" h
D.O.T. Fence Post Non-Arsenic	1416155304NA	4-5" w x 8" h
D.O.T. Fence Post Non-Arsenic	1416155045NA	5-6" w x 8'6" h



Right-of-Way Wildlife Fence Materials

Item	Product ID	Dimensions
D.O.T. Wildlife Horizontal Brace	14163040606ACQ	5.5" w x 3.5" h x 6' l
D.O.T. Wildlife Diagonal Brace	14163040610ACQ	5.5" w x 3.5" h x 10' l
D.O.T. Wildlife Line Post	14163040614ACQ	5.5" w x 3.5" h x 14' l
D.O.T. Wildlife Pull Post	14163060816ACQ	7.25" w x 5.5" h x 15' l



Pinellas-Style Fence Materials

Item	Product ID	Dimensions
Rough Cut Line Post, 2 Triangular-Shaped Notches	1416280806ACQ	8" w x 8" h x 6' l
Rough Cut Fence Rail	14162040410ACQ	4" w x 4" h x 10' l
Rough Cut Line Post, 3 Triangular-Shaped Notches	1416280806ACQ	8" w x 8" h x 7' l
Metal Rail Bracket	1417098140G	9.75" w x 6" h x 3.75' l



Fence Panels

Designed for security and privacy, PRIDE's pre-built fence panels are easy to assemble. Whether you need to isolate an area or simply reduce visibility, fence panels are the perfect solution.

Fence Panels*

Item	Product ID	Dimensions
6' Stockade Panel	1416151801NA	8'L x 6'H
8' Stockade Panel	1416151804NA	8'L x 8'H
6' Board on Board Panel	1416151811NA	8'L x 6'H
8' Board on Board Panel	1416151812NA	8'L x 8'H
6' Shadow Box Panel	1416151809NA	8'L x 6'H
8' Shadow Box Panel	1416151810NA	8'L x 8'H

*Manufactured with 1" or 3/4" planed pickets.



Dog-Eared Boards

Item	Product ID	Dimensions
Dog-Eared Board	14162010606PicketNA	5/8"W x 6"H x 6'L
Dog-Eared Board	14162010608PicketNA	5/8"W x 6"H x 8'L
Dog-Eared Board	14163010606PicketNA	3/4"W x 6"H x 6'L
Dog-Eared Board	14163010608PicketNA	3/4"W x 6"H x 8'L



Additional Information

#160969G

Customize your selections with PRIDE's color options and mounting styles.

Questions? Call for more details.

Standard Finishes

Powder-coat or Plascoat™



Carmine Red



Iron Gray



Opal Green



Oyster White



Pipe Black



Signal Blue



Signal White

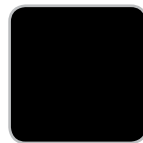

Traffic Black

Recycled Plastic



Sand

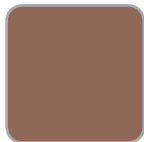

Cedar

Mounting Options

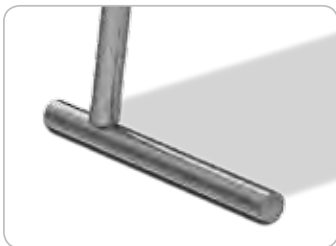

Freestanding



Surface-Mounting

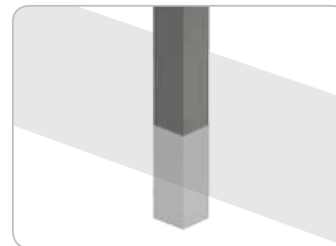

In-Ground Mounting

#160969G

Lumber

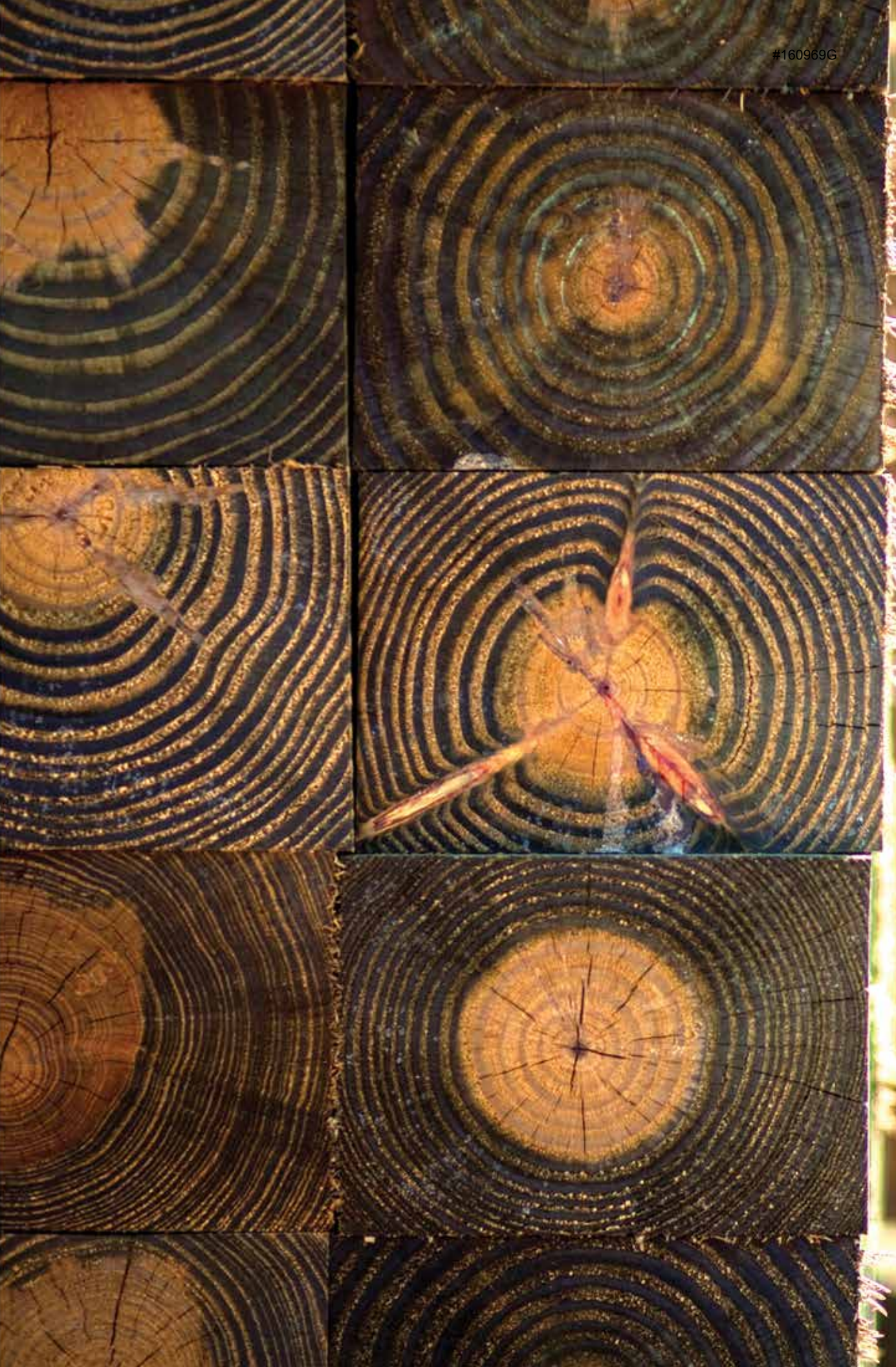

Outdoor Products • PRIDE Enterprises



Lumber

PRIDE offers a large variety of rough-cut lumber perfect for building warehouse shelving, foundations, roofing and any other projects that comes to mind.

1"

Product ID	Dimensions
14163010208	1"W x 2"H x 8'L
14163010210	1"W x 2"H x 10'L
14163010212	1"W x 2"H x 12'L
14163010214	1"W x 2"H x 14'L
14163010216	1"W x 2"H x 16'L
14163010408	1"W x 4"H x 8'L
14163010410	1"W x 4"H x 10'L
14163010412	1"W x 4"H x 12'L
14163010414	1"W x 4"H x 14'L
14163010416	1"W x 4"H x 16'L
14163010608	1"W x 6"H x 8'L
14163010610	1"W x 6"H x 10'L
14163010612	1"W x 6"H x 12'L
14163010614	1"W x 6"H x 14'L
14163010616	1"W x 6"H x 16'L
14163010808	1"W x 8"H x 8'L
14163010810	1"W x 8"H x 10'L
14163010812	1"W x 8"H x 12'L
14163010814	1"W x 8"H x 14'L
14163010816	1"W x 8"H x 16'L

2"

Product ID	Dimensions
14163020410	2"W x 4"H x 10'L
14163020412	2"W x 4"H x 12'L
14163020414	2"W x 4"H x 14'L
14163020416	2"W x 4"H x 16'L
14163020608	2"W x 6"H x 8'L
14163020610	2"W x 6"H x 10'L
14163020612	2"W x 6"H x 12'L
14163020614	2"W x 6"H x 14'L
14163020616	2"W x 6"H x 16'L
14163020808	2"W x 8"H x 8'L
14163020810	2"W x 8"H x 10'L
14163020812	2"W x 8"H x 12'L
14163020814	2"W x 8"H x 14'L
14163020816	2"W x 8"H x 16'L
14163021008	2"W x 10"H x 8'L
14163021010	2"W x 10"H x 10'L
14163021012	2"W x 10"H x 12'L
14163021014	2"W x 10"H x 14'L
14163021016	2"W x 10"H x 16'L
14163021208	2"W x 12"H x 8'L
14163021210	2"W x 12"H x 10'L
14163020408	2"W x 4"H x 8'L
14163021212	2"W x 12"H x 12'L
14163021214	2"W x 12"H x 14'L
14163021216	2"W x 12"H x 16'L

4" and 6"

Product ID	Dimensions
14163040408	4"W x 4"H x 8'L
14163040410	4"W x 4"H x 10'L
14163040412	4"W x 4"H x 12'L
14163040414	4"W x 4"H x 14'L
14163040416	4"W x 4"H x 16'L
14163040608	4"W x 6"H x 8'L
14163040610	4"W x 6"H x 10'L
14163040612	4"W x 6"H x 12'L
14163040614	4"W x 6"H x 14'L
14163040616	4"W x 6"H x 16'L
14163040808	4"W x 8"H x 8'L
14163040810	4"W x 8"H x 10'L
14163040812	4"W x 8"H x 12'L
14163040814	4"W x 8"H x 14'L
14163040816	4"W x 8"H x 16'L
14163060608	6"W x 6"H x 8'L
14163060610	6"W x 6"H x 10'L
14163060612	6"W x 6"H x 12'L
14163060614	6"W x 6"H x 14'L
14163060616	6"W x 6"H x 16'L
14163060808	6"W x 8"H x 8'L
14163060810	6"W x 8"H x 10'L
14163060812	6"W x 8"H x 12'L
14163060814	6"W x 8"H x 14'L
14163060816	6"W x 8"H x 16'L

8", 10" and 12"

Product ID	Dimensions
14163080808	8"W x 8"H x 8'L
14163080810	8"W x 8"H x 10'L
14163080812	8"W x 8"H x 12'L
14163080814	8"W x 8"H x 14'L
14163080816	8"W x 8"H x 16'L
14163101008	10"W x 10"H x 8'L
14163101010	10"W x 10"H x 10'L
14163101012	10"W x 10"H x 12'L
14163101014	10"W x 10"H x 14'L
14163101016	10"W x 10"H x 16'L
14163121208	12"W x 12"H x 8'L
14163121216	12"W x 12"H x 16'L

Assorted Lumber

#160969G

PRIDE supplies an array of assorted lumber materials for use in numerous building projects, from pilings to stakes.

Call for more information.

Pilings

Item	Product ID	Dimensions
Piling	1416155506	6.5"w x 10'L
Piling	1416155508	6.5"w x 12'L
Piling	1416155510	6.5"w x 14'L
Piling	1416155512	6.5"w x 16'L
Piling	1416155514	6.5"w x 18'L
Piling	1416155516	6.5"w x 20'L
Piling	1416152506	8"w x 10'L
Piling	1416152508	8"w x 12'L
Piling	1416152510	8"w x 14'L
Piling	1416152512	8"w x 16'L
Piling	1416152514	8"w x 18'L
Piling	1416152516	8"w x 20'L
Piling	1416152521	8"w x 25'L
Piling	1416152526	8"w x 30'L
Piling	1416154106	9"w x 10'L
Piling	1416154108	9"w x 12'L
Piling	1416154110	9"w x 14'L
Piling	1416154112	9"w x 16'L
Piling	14161542525	9"w x 18'L
Piling	1416154116	9"w x 20'L
Piling	1416154121	9"w x 25'L
Piling	1416154126	9"w x 30'L

Item	Product ID	Dimensions
Piling	141615208	10"w x 12'L
Piling	1416154210	10"w x 14'L
Piling	1416154227	10"w x 16'L
Piling	1416154228	10"w x 18'L
Piling	1416154212	10"w x 20'L
Piling	14161554114	10"w x 25'L
Piling	1416154226	10"w x 30'L
Piling	1416154231	10"w x 35'L
Piling	1416154416	12"w x 20'L
Piling	1416154414	12"w x 25'L
Piling	1416154426	12"w x 30'L
Piling	1416154430	12"w x 35'L
Piling	1416154606	14"w x 20'L
Piling	1416154621	14"w x 25'L
Piling	1416154626	14"w x 30'L
Piling	1416154631	14"w x 35'L

Posts

Item	Product ID	Dimensions
Post	1416153105	2-2.5"D x 6.5'L
Post	1416153205	2.5-3"D x 6.5'L
Post	1416155104	2-3"D x 8'L
Post	1416153305	3-3.5"D x 6.5'L
Post	1416153405	3.5-4"D x 6.5'L
Post	1416155204	3-4"D x 8'L
Post	14161553025	4-5"D x 6.5'L
Post	1416155304	4.5"D x 8'L
Post	14161554025	5-6"D x 6.5'L
Post	1416155404	5-6"D x 8'L
Post	1416155504	6-7"D x 8'L
Post	1416155604	7-8"D x 8'L

Stakes

Item	Product ID	Dimensions
3/8" w Stake	1416603802045	1.5" H x 45' L
1/2" w Stake	1416600502048	1.5" H x 48' L
3/4" w Stake	141660101036	0.75" H x 36' L
3/4" w Stake	141660101048	0.75" H x 48' L
3/4" w Stake	1416600102018	1.5" H x 18' L
3/4" w Stake	141660102024	1.5" H x 24' L
3/4" w Stake	141660102036	1.5" H x 36' L
3/4" w Stake	141660102048	1.5" H x 48' L
3/4" w Stake	141660104018	3.5" H x 18' L
3/4" w Stake	141660104024	3.5" H x 24' L
1 1/2" w Stake	141660202012	1.5" H x 12' L
1 1/2" w Stake	141660202036	1.5" H x 36' L
1 1/2" w Stake	141660202048	1.5" H x 48' L
1 1/2" w Stake	1416600204036	3.5" H x 36' L

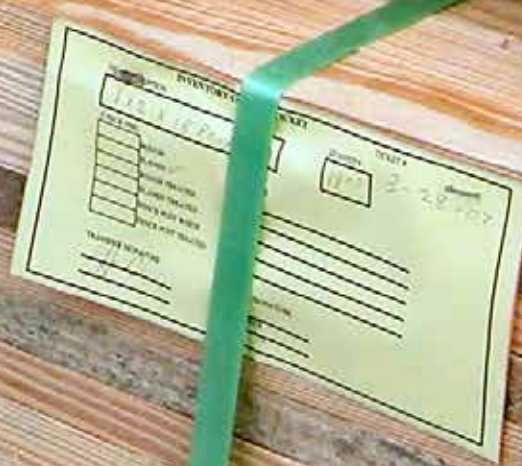

We stand behind what we sell.

WHAT DOES THE WARRANTY COVER?

PRIDE Enterprises offers a Limited Warranty on its lumber and outdoor products to be free from defects in material and workmanship for a period of: three (3) years for all metal products, five (5) years for all recycled plastic lumber products, and one (1) for all Southern Yellow Pine lumber and lumber products (treated or untreated). PRIDE's liability under its Limited Warranty is limited to the purchase price of the defective product as evidenced by the invoice. PRIDE will replace or repair the product, in lieu of refunding the purchase price at PRIDE's option. The limited warranty extends only to the original consumer and is non-transferable.

The limited warranty excludes:

- The inherent natural properties of lumber or lumber products;
- Plastic raw stock purchased and modified by the customer or third party;
- Transportation costs or customer labor costs associated with repair of warranty claims;
- Damage due to normal wear and tear (includes color fade over time);
- Damage due to improper maintenance, abuse, fire, accidents, negligent acts or omissions of the purchaser or its agents or employees or acts of third parties;
- Shipping damage (covered separately);
- Modifications, repairs, or part replacements other than those authorized by PRIDE;
- Any costs or damages for down time caused by loss of product or otherwise, or any other incidental or consequential damage incurred at any time;
- Natural variations in color, grain, or texture (includes repairs and replacements);
- Customer Owned Material (COM);
- Products used for rental purposes;
- Customer installed or assembled furniture.

Please call PRIDE, at 866.228.5135, for a quote on outdoor products and lumber. Prices are quoted from the Lumber Products facility in Union County.

Limitations involving particular materials and components:

- Surface finishes subject to PRIDE's evaluation.
- Regarding Southern Yellow Pine lumber and lumber products (treated or untreated), changes in moisture content and can cause lumber to swell, expand, contract, shrink, warp, split, twist, cup, and could cause additional changes in the product. Lumber subjected to drying conditions after manufacture can lose moisture, and an allowance must be made for the resulting shrinkage.
- Southern Yellow Pine lumber will be graded in accordance with Southern Pine Inspection Bureau Grading Standards (SPIB). Pressure treated wood will be treated according to American Wood Preserve Association (AWPA) standards for treatment. PRIDE reserves the right, in its sole discretion, to have warranty claims on Southern Yellow Pine lumber and lumber products inspected by a third party inspector per SPIB/AWPA Standards.

Warranty claims must be filed within the warranty period and must include a copy of the invoice or the sales order.

PRIDE Enterprises neither assumes nor authorizes anyone to assume for it any other obligation or liability in connection with its Lumber and Outdoor Products. **THIS WARRANTY IS THE ONLY WARRANTY APPLICABLE TO PRIDE LUMBER OR OUTDOOR PRODUCTS MANUFACTURED BY PRIDE ENTERPRISES AND IS EXPRESSLY IN LIEU OF ALL OTHER WARRANTIES, EXPRESSED OR IMPLIED, INCLUDING ANY IMPLIED WARRANTY OF MERCHANTABILITY OR FITNESS FOR A PARTICULAR PURPOSE.**

ABOUT PRIDE

PRIDE is a self-sustaining non-profit organization. We save Florida money by reducing costs associated with incarceration through job skills training and post-release transition programs.

Additionally, we make Florida communities safer. Eighty-nine percent of PRIDE inmates do not return to prison within two years of release.

MAKING BUSINESS EASY

As an instrumentality of the state, PRIDE understands the needs of Florida's agencies. PRIDE Price Agreements, our certified state contracts, allow you to directly purchase from PRIDE today.

PRODUCTS + SERVICES

The 400+ vocational job titles offered by PRIDE's 41 work programs produce over 3,000 unique products and services.



Print + Digital Services

Printing; Mailing; Scanning, Digital Storage; Forms; Boxes

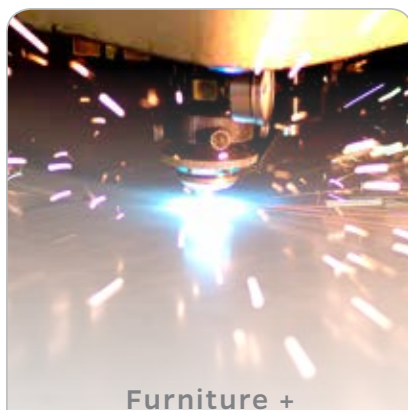

Furniture + Facility Services

Office, Outdoor and Dormitory Furniture; Cleaning Supplies; Building Signage



Laboratory Services

Dental Laboratory; Optical Laboratory



Apparel, Footwear + Bedding

Logo Wear, Uniforms, Footwear; Mattresses, Linens

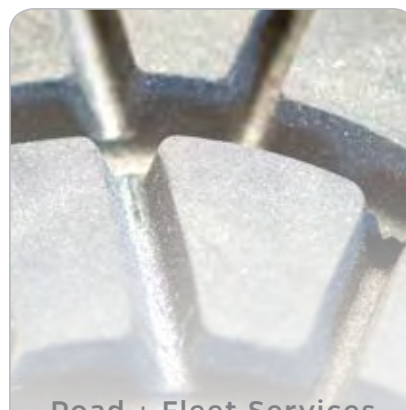

Road + Fleet Services

Heavy Vehicle Renovation; Tire Retread; Traffic Paint; DOT Guardrail and Fence Systems

HOW TO ORDER

THREE EASY OPTIONS

ON-LINE

You'll find a large selection of products just a click away.

PRIDE-ENTERPRISES.ORG



CUSTOMER SERVICE

Place an order today with Customer Service.

We're available Monday-Thursday 8am-4pm and Friday 8am-3pm to answer your questions.

866.228.5135

LOCAL SERVICE REPS

Are you taking advantage of the personal service available in your area? Your sales representative will guide your purchase experience with an extensive range of product knowledge and expertise in the purchasing process.

877.283.6819

PRIDE SALES SUPPORT

Have questions regarding other products and services? Our support representatives are available to assist you daily.

877.283.6819

#160900G

13825 N.E. 258th Lane
Raiford, FL 32083
866.228.5135
lumberproducts@pride-enterprises.org



Outdoor Products

PARK FURNITURE, FENCING, LUMBER, AND MORE