

LEGISLATIVE #

160485A

DRAFT

ORDINANCE NO. 160485

1
2
3
4
5
6
7
8
9
10
11
12
13
14
15
16
17
18
19
20
21
22
23
24
25

An ordinance of the City of Gainesville, Florida, updating, clarifying, and reorganizing the sign regulations in the Land Development Code by amending Section 30-2.1. Definitions; amending Article IX. Signs; providing directions to the codifier; providing a severability clause; providing a repealing clause; and providing an immediate effective date.

WHEREAS, Sections 163.3167 and 163.3177(1), Florida Statutes, requires the City of Gainesville to maintain a Comprehensive Plan to guide the future development and growth of the city by providing the principles, guidelines, standards, and strategies for the orderly and balanced future economic, social, physical, environmental, and fiscal development of the city; and

WHEREAS, the City of Gainesville is required by Section 163.3202, Florida Statutes, to adopt or amend and enforce land development regulations that are consistent with and implement the Comprehensive Plan, and that are combined and compiled into a single land development code for the city (the City of Gainesville’s Land Development Code is Chapter 30 of the Code of Ordinances); and

WHEREAS, Section 163.3202, Florida Statutes, requires the City of Gainesville’s Land Development Code to include certain minimum provisions, including the requirement to enact specific and detailed provisions to regulate signage; and

WHEREAS, the City of Gainesville has adopted signage regulations in the Land Development Code in accordance with Florida law and out of recognition that signs may prevent a safety hazard as well as present a safety hazard by distracting motorists, pedestrians, and other members of the public, and because signs affect the aesthetic qualities and economic vitality of the community; and

DRAFT

1 **WHEREAS**, on August 7, 2014, the City Commission adopted Ordinance No. 130157 and
2 amended the signage regulations in the City’s Land Development Code; and

3 **WHEREAS**, on June 18, 2015, the Supreme Court of the United States (*Reed v. Town of Gilbert*,
4 *Ariz.*, 135 S.Ct. 2218 (2015)) applied the First Amendment protections afforded to private
5 speech expressed through signage and further defined the constitutional requirement that
6 signage regulations must be “content-neutral”; and

7 **WHEREAS**, in response to *Reed*, the City of Gainesville has determined the need to further
8 update, clarify, and reorganize the signage regulations in the City’s Land Development Code;
9 and

10 **WHEREAS**, the City Commission finds that these sign regulations are necessary to directly
11 preserve and protect the health, safety, welfare, and general well-being of citizens by
12 promoting public safety, economic vitality, and aesthetic qualities in the City of Gainesville; and

13 **WHEREAS**, notice was given as required by law that the text of the Land Development Code of
14 the City of Gainesville, Florida, be amended; and

15 **WHEREAS**, the City Plan Board, which acts pursuant to the authority granted in Section 4.02 of
16 the Charter Laws of the City of Gainesville and which acts as the local planning agency pursuant
17 to Section 163.3174, Florida Statutes, held a public hearing on February 23, 2017, and voted to
18 recommend that the City Commission approve this text change to the Land Development Code;
19 and

20 **WHEREAS**, at least ten days’ notice has been given once by publication in a newspaper of
21 general circulation notifying the public of this proposed ordinance and of public hearings in the
22 City Hall Auditorium located on the first floor of City Hall in the City of Gainesville; and

DRAFT

1 **WHEREAS**, public hearings were held pursuant to the notice described above at which hearings
2 the parties in interest and all others had an opportunity to be and were, in fact, heard.

3 **NOW, THEREFORE, BE IT ORDAINED BY THE CITY COMMISSION OF THE CITY OF GAINESVILLE,**
4 **FLORIDA:**

5 **SECTION 1. Section 30-2.1. Definitions** of the Land Development Code (Chapter 30 of the
6 City of Gainesville Code of Ordinances) is amended to delete, add, or revise certain definitions
7 as follows. Except as amended herein, the remainder of Section 30-2.1. remains in full force
8 and effect.

9 **Section 30-2.1. Definitions.**

10 ~~**Abandoned sign** means a sign or sign structure located on a parcel(s) that has been vacant or~~
11 ~~unoccupied for a period of at least 120 consecutive days, a sign or sign structure with a message that~~
12 ~~describes the availability of goods or services at a location where such goods and services are no longer~~
13 ~~available and have ceased to be available for a period of at least 120 consecutive days, or a sign or sign~~
14 ~~structure with a message that otherwise pertains to a time, event or purpose that has elapsed or~~
15 ~~expired.~~

16
17 ~~**Animated sign** means any sign that contains text or pictorial information that moves or changes, or~~
18 ~~that uses movement or change of lighting and/or color to depict action or create a special effect or~~
19 ~~scene.~~

20
21 ~~**Contractor sign** means a temporary sign erected during construction to inform the public of the~~
22 ~~developer, contractors, architects, engineers, the nature of the project and/or anticipated completion~~
23 ~~date.~~

24
25 ~~**Moving sign** means any sign that moves or mimics movement by natural or mechanical means,~~
26 ~~including but not limited to signs designed to flutter, wave, twirl, change the direction of a plane, or~~
27 ~~mimic movement with changes in lighting, text, or pictorial information.~~

28
29 ~~**Permanent sign** means any sign that an enforcing official determines is intended to be used for an~~
30 ~~indefinite duration of time because it is constructed and attached to a building, structure, or the ground~~
31 ~~in a manner that resists environmental loads such as wind, precludes ready removal or movement of the~~
32 ~~sign, and meets any applicable Florida Building Code standards.~~

33
34 ~~**Political sign** means any sign which is designed to influence political action. Political signs may not~~
35 ~~contain commercial advertising.~~

36
37 ~~**Portable sign** means any sign, except a vehicle sign, that is not permanently erected or that may be~~

DRAFT

1 moved readily from place to place.
2

3 **Public service sign** means a sign the advertising message of which relates only to the nonprofit activities
4 of any place of religious assembly, school, governmental agency or nonprofit corporation of a religious,
5 educational or charitable nature.
6

7 **Real estate sign** means any temporary sign advertising the real property upon which the sign is located
8 for rent, lease, or sale and providing information regarding the owner or his/her agent.
9

10 **Revolving sign** means any sign or other structure so erected or constructed as to periodically change
11 the direction toward which any plane containing part of the sign area is oriented.
12

13 **Sign area** means the total surface area contained within any common geometric figure (e.g.,
14 parallelogram, circle, triangle, trapezoid, hexagon, ellipse, etc.), whether real or imaginary as
15 applicable, that encloses all the elements or copy of the sign message as provided in the definition of
16 a sign. names, letters, numbers, symbols, pictures, trademarks, logos, or other commercial messages
17 or identifications contained in a sign.
18

19 **Sign band** means a permanent architectural feature integrated into the façade of a building intended
20 for the placement of a sign(s). The measurement of the sign area shall include ~~only the actual sign~~
21 ~~elements within a sign band.~~
22

23 **Snipe sign** means any temporary sign that is attached to any object, including but not limited to a tree,
24 utility, pole, or fence post, that is either located on public property or located on private property
25 without the owner's consent. ~~made of any material and is tacked, nailed, posted, pasted, glued or~~
26 ~~otherwise attached to trees, poles, stakes, fences, or other objects.~~
27

28 **Spinner** means ~~any device designed to attract attention to the premises upon which it is displayed~~
29 ~~through mechanical movement or through movement caused by movement of the atmosphere.~~
30

31 **Temporary sign** means any sign that an enforcing official determines is not intended to be used for a
32 permanent duration of time because it does not meet the definition of permanent sign. Temporary
33 signs include, but are not limited to, banners, pennants, posters, and signs made of paper, cloth, canvas,
34 plastic sheets, cardboard, or similar materials.
35

36 **Trailer sign** means any sign, except a vehicle sign, that is designed to be readily moved from place to
37 place by its placement or display on a wheeled conveyance.
38

39 **Vehicle sign** means any sign that has a total sign area in excess of 10 square feet and that is on or
40 affixed to a transportation vehicle, including but not limited to automobiles, trucks, boats, trailers,
41 and campers. ~~motorized vehicle that has a total sign area in excess of ten square feet.~~
42
43

44 **SECTION 2. ARTICLE IX. SIGNS** of the Land Development Code (Chapter 30 of the City of
45 Gainesville Code of Ordinances) is deleted in its entirety and replaced with the following.

DRAFT

ARTICLE IX. SIGNS

~~Section 30-9.1. Short Title; Purpose and Intent.~~

~~This article shall be known as the "sign code." The purpose and intent of this sign code is to preserve and protect the health, safety, welfare, and general well being of citizens by promoting public safety, economic vitality, and aesthetic qualities through regulations for the use and maintenance of signs that are:~~

- ~~A. Compatible with their surroundings and appropriate within the parameters of the Comprehensive Plan;~~
- ~~B. Appropriate to the type of activity to which they pertain;~~
- ~~C. Expressive of the identity of the individual proprietors or of the community as a whole;~~
- ~~D. Large enough to sufficiently convey a message about the owner or occupants of a particular property, the products or services available on such property, or the business activities conducted on such property, yet small enough to preserve and protect the natural beauty of the city and limit distractions to motorists;~~
- ~~E. Not concentrated in a manner that results in clutter and unnecessary distraction to motorists;~~
- ~~F. Placed in locations that do not result in the unnecessary removal of vegetation;~~
- ~~G. Compatible to a pedestrian and motorist scale; and~~
- ~~H. Otherwise conducive to the preservation and protection of the public health, safety, and welfare.~~

~~Section 30-9.2. Applicability.~~

~~This sign code applies to the use and maintenance of all signs within the City of Gainesville.~~

~~A. Exemptions.~~

- ~~1. Signs described by the Manual of Uniform Traffic Control Devices;~~
- ~~2. Signs required by federal or state law or regulation;~~
- ~~3. Signs necessary for public safety efforts, including but not limited to signs necessary for law enforcement, fire rescue, and storm debris clean-up;~~
- ~~4. Signs indicating obstruction of a road;~~
- ~~5. Signs placed by a utility identifying underground lines, poles, above-ground lines, pipes, or other facilities; and~~
- ~~6. Signs placed by a transit company along its routes to indicate stops and routes.~~

~~B. Sign regulations elsewhere in Code of Ordinances. Sign regulations for specific uses and/or locations are provided for elsewhere in the Code of Ordinances and where there is conflict~~

DRAFT

1 ~~with this sign code, the sign regulations for specific uses and/or locations shall prevail. Sign~~
2 ~~regulations for specific uses and/or locations include, but are not limited to, the following:~~

- 3 ~~1. Shooting ranges, outdoor. See Section 30-5.24.~~
- 4 ~~2. Historic preservation/conservation district. New signs within a historic district or on~~
5 ~~property that is listed on the local or National Register of Historic Places will be~~
6 ~~approved in accordance with the Historic Preservation Rehabilitation and Design~~
7 ~~Guidelines.~~
- 8 ~~3. Sales and leasing offices, temporary. See Section 30-5.48.~~
- 9 ~~4. Bed and breakfast establishments. See Section 30-5.4.~~
- 10 ~~5. Food distribution centers for the needy, as a principal use, see Section 30-5.12. As an~~
11 ~~accessory use to a place of religious assembly, see Section 30-5.21.~~
- 12 ~~6. Farmers markets. See Section 30-5.11.~~
- 13 ~~7. Permanent development identification signs and structures. See Section 30-6.6.~~

Section 30-9.3. Prohibited Signs.

15 Any sign not expressly authorized by this sign code is prohibited. The following signs are
16 expressly prohibited within city limits, except as otherwise provided by this sign code:

- 17 ~~A. Off-premises signs;~~
- 18 ~~B. Portable signs;~~
- 19 ~~C. Vehicle signs that are parked in a location for greater than one hour and are being used as~~
20 ~~an off-premises sign;~~
- 21 ~~D. Roof signs;~~
- 22 ~~E. Electronic signs;~~
- 23 ~~F. Animated signs;~~
- 24 ~~G. Snipe signs;~~
- 25 ~~H. Revolving signs;~~
- 26 ~~I. Pennants;~~
- 27 ~~J. Spinners (See Figure 1);~~

28

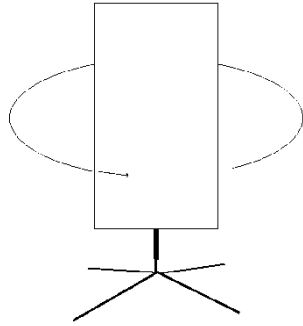

Figure 1.

1
2
3
4
5
6
7
8
9
10
11
12
13

- ~~K. Feather, flutter, bow, and twirler signs;~~
- ~~L. Sandwich boards, A frame signs, and swinger signs;~~
- ~~M. Balloons, dancing tubes, and other tethered inflatable promotional devices; and~~
- ~~N. Obscene signs.~~

Section 30-9.4. Signs Not Requiring a Permit.

The following signs may be used without a permit, provided that such signs meet the applicable regulations in this section and Section 30-9.6 and have no electrical parts or usage unless UL listed. Any signage allowable per this section is in addition to any signage allowable per Sections 30-9.7 and 30-9.8.

~~A. Signs necessary to preserve life and prevent serious injury.~~

Sign type	Max #	Max sign area (sq. feet)	Max height (feet) (freestanding signs)	Notes
Address, identification, contact information	1 per street frontage	6	6	Characters shall not exceed eight inches in height for nonresidential uses.
Direct/guide traffic and parking (building identification may be included)	N/A	6	6	Example: Parking, entrance, exit, one-way, service, etc.
General safety/caution or to prohibit trespassing	N/A	4	6	Non-illuminated.

DRAFT

Safety/caution of the location and direction of underground utility lines	1 per block face or every 200 feet, whichever is less	0.5	3	Non-illuminated. Signs should not be clustered at street corners unless required because of a directional change to the underground line.
On hospital grounds, directing the public to the emergency room-wall mounted	1 per street frontage	Lesser of 10% of the wall or 100 sq. ft.	N/A	At least one sign shall be located on front face of emergency room entry. May include directional arrows. May only read "EMERGENCY" or similar text.
On hospital grounds, directing the public to the emergency room-freestanding	1 per street frontage or entrance	24	10	

1
2

B. Signs that contain no commercial message.

Sign location	Max #	Max sign area (sq. feet)	Max height (feet)	Setback from side property line (feet)
Residential district	N/A	6	4	10
Nonresidential district	N/A	32	8	15

3
4
5
6
7
8
9
10
11

- ~~1. Signs pertaining to an event, such as an election, must be removed no later than three days after the event.~~
- ~~2. The allowable signage in this subsection is in addition to the general provision in Section 30-9.6 regarding substitution of messages, where any signage otherwise permitted per Sections 30-9.7 and 30-9.8 may at the option of the owner contain either a commercial or noncommercial message, provided that the sign otherwise meets the provisions of this sign code.~~

C. Contractor signs.

Sign location	Max #	Max sign area	Max height	Setback from
----------------------	--------------	----------------------	-------------------	---------------------

DRAFT

		(sq. feet)	(feet)	property line and from driveway (feet)
Individual single family homes	3	6	4	10
Subdivision and multi-family developments	3	32	8	10
Nonresidential district	3	32	8	15

- 1 ~~1. May not be displayed until after the issuance of construction permits by the building~~
2 ~~official.~~
- 3 ~~2. Shall be removed no later than three days after the final Certificate of Occupancy is~~
4 ~~issued.~~

5 ~~D. Real estate signs.~~

Sign location	Max #	Max sign area (sq. feet)	Max height (feet)	Setback from property line and from driveway (feet)
Residential district	3	6	4	10
Nonresidential district	3	32	8	10

- 6 ~~1. Shall be removed no later than three days after the property is no longer for rent, lease,~~
7 ~~or sale.~~

8 ~~E. Miscellaneous signs.~~

Sign type or location	Max #	Max sign area (sq. feet)	Max height (feet)	Notes
Open, closed, hours of operation (Building mounted only)	1 for each entrance/exit	4	NA	Information pertinent to the business operation.
Non-illuminated	NA	12	NA	Signage in excess of this

DRAFT

window signs				standard shall be counted as part of the building-mounted signage allowance.
Signs on the body of coin-operated vending machines, gasoline pumps, telephone booths and ice vending equipment	NA	NA	NA	
Signs on an umbrella attached to a table at an outdoor eating place or alcoholic beverage establishment	NA	NA	NA	Table and umbrella must be otherwise lawfully permitted.
Decorative vertical pole banners	NA	18	NA	Pole must be lawfully permitted and serve a dual purpose such as light poles.
Signs that are a permanent architectural feature of the building or structure	NA	NA	NA	Such as a cornerstone or other identifying letters carved into or embossed on the building, provided such letters are not illuminated apart from the building, are not made of a reflective material and do not contrast in color with the building.
Garage, yard, or estate sales	±	NA	NA	Must be on the premises of the associated dwelling and shall be removed no later than three days after the event.

1

2 ~~F. Pedestrian-oriented signs.~~

Sign type	Max #	Max sign area	Max height	Notes
------------------	--------------	----------------------	-------------------	--------------

DRAFT

		(sq. feet)	(feet)	
Under canopy	1	4	NA	Permanently attached. Minimum 9-foot vertical clearance under sign. Not internally illuminated.
Pedestal	Either 1 pedestal sign or 1 message board sign	2.25	5	Permanently attached to ground. Outside of right of way and any pedestrian walkway. May be internally illuminated.
Message board	Either 1 pedestal sign or 1 message board sign	6	NA	Permanently attached to wall, door, or window. May be mounted in a protective frame up to 6 inches deep. May be internally illuminated.

1

2 **G. ~~Flags.~~**

Sign location	Max flagpole height (feet)	Recommended flag dimensions (h x w) (feet)
Residential districts	25'	4'x6'
Nonresidential districts	30'	6'x10'

3

1. ~~A flagpole may be freestanding or building mounted.~~

4

2. ~~The vertical dimension of the flag shall be a maximum of 20% of the height of the flagpole.~~

5

3. ~~Freestanding flagpoles shall be set back at least 10 feet from any property line.~~

6

4. ~~Shall not contain a commercial message.~~

7

8 **H. ~~Strip lighting.~~**

9

1. ~~Shall be no greater than one inch in diameter.~~

10

2. ~~Shall be made of neon or some similar material that gives the appearance of neon.~~

11

3. ~~Shall not face any property zoned or developed as single family residential that is located within 200 feet of the strip lighting.~~

12

4. ~~Shall obtain all necessary electrical permits.~~

13

5. ~~Shall be separated by at least five feet from any signs so that it would in no way be construed as being part of the total area allowed for the signs.~~

14

15

DRAFT

1 ~~6. Shall not contain a commercial message.~~

2 ~~I. *Murals and other works of art.* Murals and other works of art, as defined in Chapter 5.5 of~~
3 ~~the Code of Ordinances, shall not require a sign permit provided that they meet any~~
4 ~~applicable regulations in Section 30-9.6 and have no electrical parts or usage unless UL~~
5 ~~listed, and contain no commercial message. Any part of a mural or work of art that contains~~
6 ~~a commercial message shall require a sign permit and shall be included within the~~
7 ~~applicable calculation of maximum allowable sign area.~~

8 ~~Section 30-9.5. Permitting.~~

9 ~~A. *Permit required.* Unless otherwise expressly authorized by this sign code, it shall be unlawful~~
10 ~~to use, erect or cause to be erected, maintain or cause to be maintained, alter or extend~~
11 ~~any new or existing sign without first obtaining a permit from the city.~~

12 ~~B. *Interim signs.* An owner or designated agent who has moved to a new location or whose~~
13 ~~existing sign is being replaced due to damage, destruction, or to make it conforming to this~~
14 ~~sign code may apply, at no fee, for an interim sign permit. The permit shall expire 120 days~~
15 ~~from issuance or when a permanent sign is installed and permitted according to this~~
16 ~~section, whichever occurs first. Interim sign permits may not be extended or renewed and~~
17 ~~interim signs shall be removed within 3 days after expiration of the interim sign permit.~~

18 ~~C. *Application.* The owner or designated agent shall apply for any sign permits required by this~~
19 ~~sign code by submitting an application to the office of the building official on a form~~
20 ~~furnished by the city. All applications shall include the following:~~

21 ~~1. The street address of the real property upon which the sign is to be located and the~~
22 ~~proposed location of the sign on the property. In the absence of a street address, a~~
23 ~~method of location acceptable to the City Manager or designee shall be used.~~

24 ~~2. The name and address of the owner or other person in control or possession of the real~~
25 ~~property upon which the sign is to be located.~~

26 ~~3. Written consent of such owner, his/her lessee, or his/her agent, granting permission for~~
27 ~~the construction, operation, maintenance or display of the sign.~~

28 ~~4. The name of the sign contractor, if any.~~

29 ~~5. The type of sign as defined in this sign code.~~

30 ~~6. A map showing all structures, all street frontages, the location of all existing and~~
31 ~~proposed sign(s), a north arrow, and all trees having a diameter of 12 inches or more at~~
32 ~~a height of 4 ½ feet above the ground that will be removed for the construction and~~
33 ~~display of the sign.~~

34 ~~7. A plan, sketch, blueprint, blue line print or similar presentation drawn to scale, showing~~
35 ~~all pertinent structural details, wind pressure requirements, display materials, and other~~
36 ~~information in accordance with the requirements of the Standard Building Code.~~

DRAFT

1 ~~8. The height, shape and dimensions of the sign structure, if any, and the dimensions and~~
2 ~~shape of the sign area.~~

3 ~~9. A landscape plan that includes, at a minimum, the size (in gallons) of any required plants~~
4 ~~and the common and scientific names of the plants, all of which shall be healthy, disease~~
5 ~~and pest free, and hardy for the North Florida region. Plant height shown on the sign~~
6 ~~elevations shall be the height expected within two years.~~

7 ~~10. The actual cost of the sign.~~

8 ~~11. Any other information reasonably required by the City Manager or designee to~~
9 ~~determine whether such sign is in compliance with the requirements of this sign code.~~

10 ~~D. Procedure.~~

11 ~~1. Time limit. The City Manager or designee shall grant or deny a sign permit application~~
12 ~~within 30 days from the date a completed application and payment of the permit fee~~
13 ~~was submitted to the city. If the City Manager or designee fails to take action by either~~
14 ~~granting or denying a sign permit application within this specified period, it shall be~~
15 ~~deemed approved.~~

16 ~~2. Issuance or denial of permit.~~

17 ~~a. If the City Manager or designee determines that the application meets the~~
18 ~~requirements of this sign code and all building, electrical and other applicable~~
19 ~~regulations of the city, the City Manager or designee shall approve the application~~
20 ~~and issue the sign permit contingent on an inspection after installation/alteration.~~

21 ~~b. If the City Manager or designee determines that the application fails to meet one or~~
22 ~~more requirements of this sign code or building, electrical or other applicable~~
23 ~~regulations of the city, the City Manager or designee shall deny the application and~~
24 ~~shall make a written report of the denial and the reasons therefore. A copy of the~~
25 ~~report shall be sent by certified mail to the applicant.~~

26 ~~c. If the application is denied, the applicant may submit an amended application within~~
27 ~~15 days of the date posted on the notice of denial without additional cost. The City~~
28 ~~Manager or designee shall grant or deny an amended application within 30 days of~~
29 ~~receipt. If the City Manager or designee fails to take action by either granting or~~
30 ~~denying an amended application within this specified period, it shall be deemed~~
31 ~~approved.~~

32 ~~3. Appeal. The decision of the City Manager or designee to approve or deny a sign permit~~
33 ~~application is an administrative decision that can be appealed as provided in this~~
34 ~~chapter.~~

35 ~~E. Fees. Applications for a sign permit shall be accompanied by a fee in the amount established~~
36 ~~by the buildings and building regulations section set forth in Appendix A.~~

DRAFT

1 ~~F. Expiration of permit. Any sign permit issued pursuant to this sign code shall expire within six~~
2 ~~months after the date of issuance, unless such signs are constructed and installed within the~~
3 ~~six-month period.~~

4 ~~G. Penalty. Notwithstanding any other provision of this chapter, a fee of double the amount~~
5 ~~normally required for the sign permit shall be charged for any work commenced without an~~
6 ~~issued permit.~~

7 **Section 30-9.6. General Regulations for All Signs.**

8 ~~A. Location.~~

9 ~~1. Traffic and pedestrian hazards. No sign shall be located in such a manner as to obstruct~~
10 ~~the vision of pedestrians or motorists, including obstructions within the vision triangle~~
11 ~~as provided in the Engineering Design and Construction Manual. However, signs may be~~
12 ~~located at least eight feet above the highest crown of any adjacent street when such~~
13 ~~sign is mounted upon a sign support structure that does not exceed 8 inches in~~
14 ~~diameter. Any sign producing glare or a method of illumination that constitutes a hazard~~
15 ~~to traffic is prohibited. No sign may use the words "Stop," "Look," "Drive in," "Danger"~~
16 ~~or any similar word, phrase, symbol or character within ten feet of a public right-of-way~~
17 ~~or 200 feet of a traffic control device.~~

18 ~~2. Building ingress/egress. Signs shall not be located in such a manner as to obstruct~~
19 ~~ingress/egress through any door or window required or designed for ingress/egress to~~
20 ~~any building, and shall not obstruct or be attached to a fire escape.~~

21 ~~3. Right of way. No signs, other than signs identifying public property, shall be located in~~
22 ~~or on any public right of way.~~

23 ~~B. Measurement.~~

24 ~~1. Sign height. The height of a freestanding sign shall be measured vertically from the~~
25 ~~established average grade directly below the sign to the elevation of the highest point of~~
26 ~~the sign.~~

27 ~~2. Distance between signs. The minimum required distance between signs shall be~~
28 ~~measured from the closest parts of any two sign areas.~~

29 ~~3. Sign area.~~

30 ~~a. The sign area shall be calculated as defined.~~

31

DRAFT

Sign Area = Height x Width

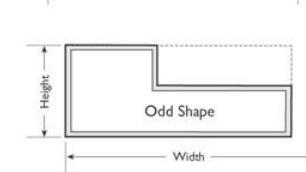
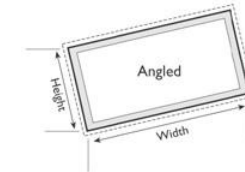
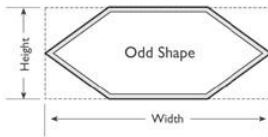
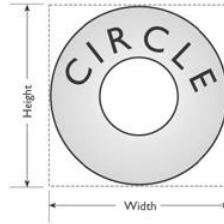
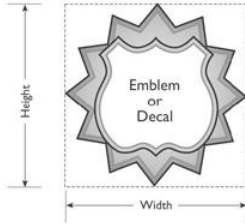

1
2
3
4
5

~~b. Double faced signs shall be counted as a single faced sign when the two faces are parallel or at an angle of less than 45 degrees. Where the faces are not equal in size, the larger sign face shall be used as the basis for calculating sign area.~~

Total Sign Area = Face A or Face B, whichever is larger

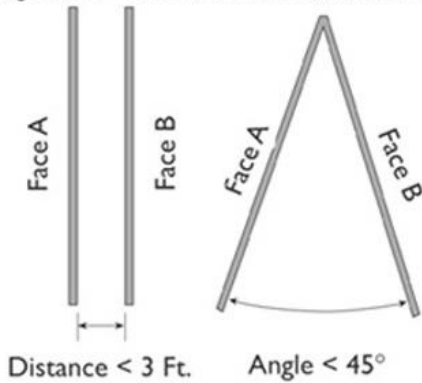

6
7
8
9
10

~~c. Signs with three or more sign faces, or signs with two sign faces with a distance greater than three feet apart or an interior angle equal to or greater than 45 degrees, shall calculate the sign area as the sum of all the sign faces.~~

1

Total Sign Area = Sum of All Sign-Faces

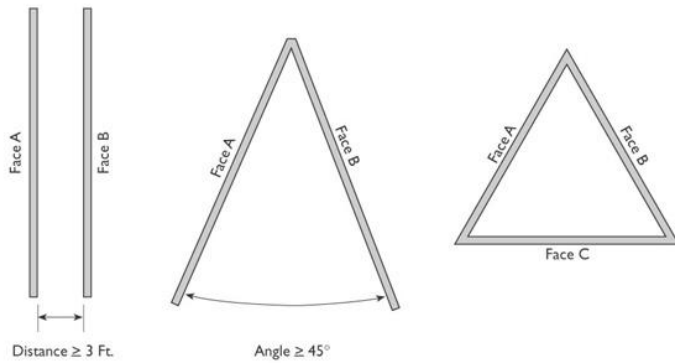

2
3

4 ~~C. Illumination.~~

- 5 ~~1. Signs may be illuminated with a steady light. Illumination that gives the effect of~~
- 6 ~~blinking, flashing, or moving is prohibited.~~
- 7 ~~2. Sign illumination shall be designed to minimize light pollution and shall meet the light~~
- 8 ~~trespass requirements set forth in the outdoor lighting section of the Land Development~~
- 9 ~~Code.~~
- 10 ~~3. Colored lights. Colored lights shall be designed to prevent confusion with traffic control~~
- 11 ~~signals. No sign located within 10 feet of public right-of-way or within 200 feet of traffic~~
- 12 ~~control signals shall contain red or green lights. Color changing light or lighting,~~
- 13 ~~including when located in, on, or near a window or transparent door and intended to be~~
- 14 ~~visible to members of the public who are located outdoors, is prohibited.~~
- 15 ~~4. Bare bulb illumination. Bare bulb illumination of signs is permitted only in districts~~
- 16 ~~zoned MU 1, MU 2, BUS, BA, BT, DT, U8, and U9.~~
- 17 ~~5. Flame. Flame as a source of light for signs is permitted if it meets adequate fire safety~~
- 18 ~~standards as prescribed by the City Manager or designee.~~

19 ~~D. Substitution of message. Any sign used in conformance with the provisions of this sign code~~
20 ~~may at the option of the owner contain either a commercial or noncommercial message.~~

21 **Section 30-9.7. Permanent Signs.**

22 ~~A. In general. Permanent signs are signs that are intended to be used for an indefinite period~~
23 ~~of time and that are attached to a building, structure or to the ground in a manner that~~
24 ~~resists environmental loads, such as wind, precludes ready removal or movement of the~~
25 ~~sign, and meets applicable Florida Building Code standards. Permanent signs include but~~
26 ~~are not limited to building-mounted signs, freestanding signs, identification signs and~~
27 ~~directional signs.~~

DRAFT

~~B. *Building-mounted signs.* Building-mounted sign allowance may be used by a combination of wall, window, mansard, parapet, awning, marquee, or canopy signs, and shall not exceed the maximum sign area established below. Except where otherwise specifically provided, building-mounted signs may be permitted as follows.~~

~~1. *General provisions.*~~

~~a. *Projecting.* Signs shall not extend horizontally beyond the edges of the awning, marquee, mansard, or parapet to which they are attached or from which they are suspended and no more than four feet horizontally from the wall. Signs shall not project vertically above the roofline. Such signs under which a pedestrian walkway passes must have at least a nine-foot vertical clearance.~~

~~b. *Canopy.* Permitted only when canopy is connected to the principal building, in which case the face of the canopy is considered a part of the face of the principal building.~~

~~c. *Wall.* Where a wall supporting a building-mounted sign is less than 12 inches from a public right-of-way, the wall sign may project over the right-of-way, provided it does not project more than 12 inches from the wall.~~

~~d. *Common area.* The allowable sign area of two or more occupants may be placed on a commonly owned area of a multi-occupancy development, provided that only one sign may be displayed at each entrance.~~

~~2. *Residential districts.*~~

Sign Type	Max #	Max sign area (sq. feet)
Building-mounted	Principal use: 1 Accessory use (if applicable): 1	Principal: 24 Accessory: 18

~~3. *Nonresidential districts.*~~

~~a. *Single and multiple-occupancy developments – two stories or less.*~~

Sign type	Max #	Max sign area (sq. feet)
Occupant	2 per occupant, plus: Additional: 1 for each exterior building wall that is part of an occupant's space	Length of leased space x 1.5, up to 200 max aggregate per occupant, plus: Additional: 50 second side 24 third side 24 fourth side
Directional	1	6

DRAFT

1 ~~b. Single and multiple occupancy developments — greater than two stories.~~

Sign type	Max #	Max sign area (sq. feet)
Primary	2 (3 if primary frontage greater than 500 linear feet), plus: Additional: 1 for each exterior building wall	300 max aggregate
Occupant	2 per occupant, within the building sign band	Length of leased space x 1.5, up to 100 max aggregate per occupant
Directional	1	6

2 ~~4. Parking garage. Building mounted signs with a maximum aggregate sign area of 75~~
 3 ~~square feet per street frontage may be permitted. In addition, if the parking garage has~~
 4 ~~ground floor retail, each occupant is allowed two signs equal to the width of leased~~
 5 ~~space x 1.5, up to a maximum aggregate of 100 square feet per occupant. At each~~
 6 ~~vehicle entrance to the parking garage, two directional signs (entrance /exit) are~~
 7 ~~allowed with a maximum sign area of six square feet each.~~

8 ~~c. Freestanding signs. Except where otherwise specifically provided, freestanding signs may~~
 9 ~~be permitted as follows:~~

10 ~~1. Residential districts.~~

Sign Type	Max #	Max sign area (sq. feet)	Max height (feet)
Freestanding	1	32 — Monument 24 — Pole	8

11

12 ~~2. Nonresidential districts.~~

Sign Type	Max # (See a. below)	Max sign area (sq. feet) (See b. below)	Max height (feet)
Primary frontage	1	Monument: — Frontage up to 50 ft.: 32 — Frontage 51-100 ft.: 40 — Frontage 101 ft. or more: frontage x 0.5, up to 120	10

DRAFT

		Pole: — Frontage up to 50 ft.: 24 — Frontage 51-100 ft.: 32 — Frontage 101 ft. or more: frontage x 0.4, up to 96	
Additional primary frontage	1 additional if primary frontage greater than 500 linear feet	75 — monument 50 — pole	10
Secondary frontage	±	30 — monument 24 — pole	8
Outparcel	±	Frontage 151-200 ft.: — 38 — monument — 32 — pole Frontage 201 ft. or more: — 58 — monument — 48 — pole	8
Directional for developments with greater than 300,000 square feet of floor area	N/A (shall not be located within 100 feet of any public right-of-way)	50 (single occupancy developments shall be limited to two square feet per individual sign face)	6

1
2
3
4
5
6
7
8
9
10
11
12
13
14

a. ~~Max #.~~ Each single or multiple occupancy development shall be allowed one primary frontage freestanding sign. One additional primary frontage sign shall be allowed on any primary frontage that is greater than 500 linear feet, and must be located at least 50 feet from any other sign. A single or multiple occupancy development with a secondary frontage shall be allowed one additional freestanding sign on the secondary frontage.

A freestanding sign shall be allowed on developed outparcels that are greater than 22,500 square feet in area and have a street frontage that is greater than 150 linear feet. An allowable freestanding sign on a corner outparcel may be located along either street frontage, provided it otherwise meets the requirements of this chapter.

b. ~~Max sign area.~~ A freestanding sign may be either a monument sign or a pole-mounted sign. A size bonus is provided for monument signs. No signage shall be displayed on the base of any monument sign.

DRAFT

~~c. *Setback.* Frontage signs shall be setback from the corresponding frontage ends at a distance equal to 10% of the length of the frontage, with a minimum setback of ten feet and a maximum setback of 50 feet.~~

~~3. *I-75 corridor signs.*~~

~~a. For purposes of this subsection, I-75 corridor signage shall be restricted to permitted uses in nonresidential districts that are located within one-fourth mile of the centroid of an I-75 interchange with any arterial roadway.~~

~~b. In addition to signage otherwise allowable per this sign code, an additional freestanding sign with a maximum height of 18 feet shall be allowed on a development (including outparcels), provided that the sign area of such sign in combination with other permitted signs on the development does not exceed a maximum sign area of 300 square feet. Such sign shall be readily visible from I-75. The location of this sign shall not be limited to properties actually abutting I-75; however, no I-75 corridor sign shall be located on any frontage where the adjacent or facing properties are designated single-family on the future land use map.~~

~~c. *Height extension.* An owner or designated agent may apply for a height extension to allow for an I-75 corridor sign with a maximum height greater than 18 feet. However, under no circumstances may a sign exceed a height of 90 feet. Applications for a height extension shall be accompanied by a fee in the amount established for a variance as set forth in Appendix A. The City Plan Board shall review height extension applications and shall approve or deny the application based upon the following special considerations. The City Plan Board shall approve an application for a height extension only when the applicant proves each of the following requirements:~~

~~i. A registered engineer certifies or other reliable documentary evidence proves that, due to special conditions and circumstances relative to topography, vegetation or the built environment, a sign with a height of 18 feet or less cannot be seen by motorists on I-75 at a distance of one-fourth mile from the nearest exit ramp;~~

~~ii. The height extension requested is the minimum necessary to achieve such visibility;~~

~~iii. The circumstances and/or special conditions do not result from the actions of the applicant;~~

~~iv. The height extension will have general compatibility and harmony with the uses and structures on adjacent and nearby properties; and~~

~~v. The sign otherwise complies with all applicable regulations of this sign code.~~

~~The City Plan Board may prescribe appropriate conditions and safeguards to ensure the structural integrity and safety of the sign and to landscape and buffer the sign~~

DRAFT

1 structure to ensure compatibility and harmony with the uses and structures on
 2 adjacent and nearby properties.

3 ~~D. Identification signs.~~

4 ~~1. Multiple family residential development, community residential home with more than 14~~
 5 ~~residents, and mobile home park identification signs.~~

Sign Type	Max #	Max sign area (sq. feet)	Max height (feet)
Identification	1 per entrance; may be one double-sided sign or two single-faced signs on either side of an entrance	Primary entrance, less than 6 units: 16 Primary entrance, 6 or more units: 24 Additional entrance(s): 16	8

6 a. ~~If the property has more than one frontage but no approved entrance on the~~
 7 ~~additional frontage(s), one additional sign may be placed on one additional frontage~~
 8 ~~and will be regulated as an additional entrance sign.~~

9 ~~2. Residential subdivision, nonresidential subdivision, and neighborhood identification~~
 10 ~~signs.~~

Sign Type	Max #	Max sign area (sq. feet)	Max height (feet)
Residential subdivisions and neighborhood signs	1 per entrance; may be one double-sided sign or two single-faced signs on either side of an entrance	Primary entrance: 24 Additional entrance(s): 16	8
Nonresidential subdivisions	1 per entrance; may be one double-sided sign or two single-faced signs on either side of an entrance	Per lot: 6 Max 115 — monument Max 96 — pole	8
Minor subdivisions	1	18	8

11
 12 ~~E. Gainesville Regional Airport.~~

Sign Type	Max #	Max sign area (sq. feet)	Max height (feet)	Notes
Freestanding	4	360 max aggregate for all freestanding signs	10	

DRAFT

Building-mounted				As approved by the Gainesville Alachua County Regional Airport Authority (GACRAA); no city approval required
Directional				As approved by the Gainesville Alachua County Regional Airport Authority (GACRAA); no city approval required

Section 30-9.8. Temporary Signs.

~~A. In general.~~ Temporary signs are signs not intended for permanent installation that are to be used for a limited period of time. Temporary signs shall not be illuminated and shall be constructed and affixed to the ground, an existing permanent sign, or a structure in such a way that does not create a safety hazard and that complies with applicable Florida Building Code standards.

~~B. Special events.~~

~~1. Signs that fall in this category include, but are not limited to, signs related to special events, sales events, future openings, grand openings, and leasing of rental property.~~

~~2. The sign may be posted no earlier than ten days prior to the event or activity and must be removed no later than three days after the event or activity ends, and may be posted for a total of no more than 60 consecutive days per event. Unless otherwise permitted by the Land Development Code, signs under this subsection may be used for no more than two events per year.~~

Sign location	Max #	Max sign area (sq. feet)	Max height (feet)	Setback from side property line (feet)
Residential district	1 per property in single-family district. 4 per multi family development.	6	4	10
Nonresidential district	2 per development.	32	8	15

~~C. Street banners.~~

~~1. No sign may be erected, constructed or maintained along or across any public streets, except across street and vertical pole banners shall be permitted over or along certain~~

DRAFT

1 streets designated by the City Manager and the General Manager for Utilities. An
2 application shall be filed with the City Manager or designee together with a banner
3 installation fee in an amount prescribed by the General Manager for Utilities to allow
4 full cost recovery to the city. The following conditions and regulations shall apply:

5 a. ~~Banners shall relate to an event that will be open to the general public and that is~~
6 ~~scheduled to occur within the city or unincorporated Alachua County.~~

7 b. ~~Banners shall not contain: 1) any commercial message; 2) any phone numbers or~~
8 ~~addresses; or 3) any traffic directions or traffic signage that may cause a traffic or~~
9 ~~pedestrian hazard.~~

10 c. ~~The City will install street banners no more than 14 days prior to the event and will~~
11 ~~remove them no later than seven days following the event.~~

Section 30-9.9. ~~Sign Maintenance.~~

13 A. ~~All signs and sign structures regulated by this chapter, including any supports, braces, guys~~
14 ~~and anchors, electrical parts, lighting fixtures and all painted and display areas shall be~~
15 ~~maintained to present a neat, clean appearance and maintained in a safe condition. Painted~~
16 ~~areas and sign surfaces shall be kept in good condition, and illumination, if provided, shall~~
17 ~~be maintained in safe and good working order.~~

18 B. ~~Weeds and grass shall be kept cut in front of, behind, underneath and around the base of~~
19 ~~freestanding signs for a distance of ten feet, and no rubbish or debris shall be permitted~~
20 ~~under or near such signs.~~

21 C. ~~Any sign that becomes dilapidated, run down, or a safety hazard shall be repaired or~~
22 ~~removed by the owner or designated agent.~~

Section 30-9.10. ~~Nonconforming and Abandoned Signs.~~

24 A. ~~Nonconforming signs.~~ Any sign that does not comply with the requirements of this chapter,
25 but for which a permit has previously been issued by either the city or Alachua County, shall
26 be deemed legally nonconforming. The owner of any legally nonconforming sign or the
27 owner of any property upon which such sign is located shall bear the burden of proving that
28 such sign is a legally nonconforming sign. All other signs that do not comply with the
29 requirements of this chapter and that are not legally nonconforming shall immediately be
30 removed or brought into compliance with this chapter.

31 1. ~~All legally nonconforming signs shall be allowed to remain as originally permitted.~~

32 2. ~~Reasonable repair and maintenance necessary to keep a legally nonconforming signs in~~
33 ~~a good state of repair is allowed, and may include but is not limited to:~~

34 a. ~~Changing light bulbs, neon, or other light source;~~

35 b. ~~Changing the face of a cabinet sign, or other modification that only involves a~~
36 ~~change of copy;~~

37 c. ~~Replacing cladding or other components that hold a sign face in place;~~

DRAFT

- 1 ~~d. Painting, cleaning, and other maintenance activities that do not affect the type,~~
2 ~~height, or size of the sign structure; and~~
- 3 ~~e. Repairing electrical components.~~
- 4 ~~3. Reasonable repair and maintenance does not include, by way of example and not~~
5 ~~limitation:~~
- 6 ~~a. Any modification that changes the structure or type of structure, such as conversion~~
7 ~~of a wooden sign structure to a metal sign structure, or otherwise prolongs the life~~
8 ~~of the sign structure;~~
- 9 ~~b. Any modification, including the addition of embellishments, that changes the sign~~
10 ~~area or the height above ground level; and~~
- 11 ~~c. Any modification that adds internal or external illumination, or increases the existing~~
12 ~~illumination.~~
- 13 ~~4. A legally nonconforming sign shall be removed or brought into compliance with this sign~~
14 ~~code if any of the following conditions apply:~~
- 15 ~~a. The sign becomes damaged, destroyed or deteriorated by any means to the extent~~
16 ~~that it requires more than reasonable repair and maintenance, as described in~~
17 ~~Subsection 2 above, or if the cost of renovation or repair exceeds 50% of the~~
18 ~~replacement cost of the sign;~~
- 19 ~~b. The principal structure on the parcel or parcels is demolished or requires~~
20 ~~renovations the costs of which exceed 50% of the assessed value of the structure; or~~
- 21 ~~c. The nonconforming sign is moved for any reason.~~
- 22 ~~5. *Historic signs.* A sign that has been added to the local historic register in accordance~~
23 ~~with Section 30 4.28 shall not be considered a nonconforming sign and shall be exempt~~
24 ~~from the limitations of this subsection.~~
- 25 ~~B. *Abandoned signs.*~~
- 26 ~~1. A nonconforming abandoned sign shall be removed or brought into compliance within~~
27 ~~30 days after it is deemed abandoned.~~
- 28 ~~2. An abandoned sign that otherwise complies with the requirements of this sign code may~~
29 ~~remain, provided the owner takes one of the following actions:~~
- 30 ~~a. Paints over or otherwise conceals the message on the sign;~~
- 31 ~~b. Removes the sign face and replaces it with a blank sign face;~~
- 32 ~~c. Reverses the sign face and does not illuminate the sign; or~~
- 33 ~~d. Uses the sign structure to display the message "this space available" or words of~~
34 ~~similar significance, and the name and telephone number of the owner or the~~
35 ~~owner's agent, while the premises are vacant. A sign which contains such a message~~

DRAFT

1 shall be deemed an allowable real estate sign for which a permit shall not be
2 required.

3 **Section 30-9.11. Enforcement.**

4 ~~A. *Duties of enforcing official.* The City Manager or designee shall be the enforcing official. The~~
5 ~~enforcing official is charged with the duty of administering and securing compliance with~~
6 ~~the provisions of this sign code. In furtherance of this responsibility, the enforcing official~~
7 ~~shall:~~

- 8 ~~1. Make such inspections as may be necessary to bring about the purpose and intent of~~
9 ~~this sign code and initiate appropriate action to bring about compliance if such~~
10 ~~inspection discloses any instance of noncompliance;~~
- 11 ~~2. Investigate thoroughly any complaints of alleged violations of this sign code, and~~
12 ~~indicate clearly in writing as a public record in his/her office the disposition made of~~
13 ~~such complaints;~~
- 14 ~~3. Order in writing as set out below the remedy of all conditions or all violations of the sign~~
15 ~~code found to exist in or on any premises;~~
- 16 ~~4. State in the violation order a time limit for compliance; and~~
- 17 ~~5. Request the assistance of the City Attorney in taking appropriate legal action upon the~~
18 ~~failure of the responsible party to comply with such violation order by the time specified~~
19 ~~therein.~~

20 ~~B. *Right of entry.* The enforcing official or his/her agent is authorized and directed to lawfully~~
21 ~~enter in and upon all premises at reasonable times to determine their condition insofar as~~
22 ~~the provisions of this sign code are applicable.~~

23 ~~C. *Contents of notice of violation.* Whenever the enforcing official determines that a violation~~
24 ~~of this sign code exists, the official is authorized to issue a citation pursuant to Section 2-337~~
25 ~~of the Code of Ordinances. Time for compliance shall be as follows:~~

- 26 ~~1. For all prohibited signs as specified in Section 30-9.3, temporary signs as specified in~~
27 ~~Section 30-9.8, and all other signs of a nonpermanent nature, the time may not be less~~
28 ~~than one hour nor more than 24 hours from the time of such written notice. However,~~
29 ~~any condition found to exist in violation of this sign code that constitutes a hazard to the~~
30 ~~public safety shall be required to be abated immediately.~~
- 31 ~~2. All other signs. For all signs not specified in Subsection C.1. of this section, the time may~~
32 ~~not be less than ten days nor more than 90 days from the date of such written notice.~~
33 ~~However, any condition found to exist in violation of this sign code that constitutes a~~
34 ~~hazard to the public safety shall be required to be abated immediately.~~

35 ~~D. *Unauthorized signs in right of way.* Any sign placed in the public right of way in violation of~~
36 ~~this sign code shall be deemed to be abandoned and may be removed immediately by an~~
37 ~~enforcing official or agent. Any sign so removed may be disposed of by the city without~~

DRAFT

1 ~~notice or compensation. This removal shall not preclude prosecution or imposition of~~
2 ~~penalties for violation of this sign code.~~

3 ~~E. The enforcing official or agent may cause any sign that is a hazard or poses immediate peril~~
4 ~~to persons or property to be removed immediately at the expense of the owner, lessee or~~
5 ~~other person having beneficial use of the sign, or the owner or lessee of the land upon~~
6 ~~which the sign is located.~~

7

8

9

ARTICLE IX. SIGNS

10 **Section 30-9.1. Purpose.**

11 This article shall be known as the "sign code." The intent of this sign code is to preserve and protect the
12 health, safety, welfare, and general well-being of citizens by promoting public safety, economic vitality,
13 and aesthetic qualities through regulations for the use and maintenance of signs that are:

14 A. Compatible with their surroundings and appropriate within the parameters of the Comprehensive
15 Plan;

16 B. Appropriate to the location to which they pertain;

17 C. Large enough to sufficiently convey a message, yet small enough to preserve and protect the natural
18 beauty of the city and limit distractions to motorists;

19 D. Not concentrated in a manner that results in clutter and unnecessary distraction to motorists;

20 E. Placed in locations that do not result in the unnecessary removal of vegetation;

21 F. Compatible to a pedestrian and motorist scale; and

22 G. Otherwise conducive to the preservation and protection of the public health, safety, and welfare.

23 **Section 30-9.2. Applicability.**

24 This sign code applies to the use and maintenance of all signs within the City of Gainesville, unless
25 otherwise provided for in accordance with federal, state, or local law.

26 **Section 30-9.3. Prohibited Signs.**

27 Any sign not expressly authorized by this sign code is prohibited. The following signs are expressly
28 prohibited within city limits, except as otherwise provided by this sign code:

29 A. Off-premises signs;

30 B. Trailer signs;

31 C. Vehicle signs that are parked in a location for greater than one hour and are being used as an off-
32 premises sign;

33 D. Roof signs;

34 E. Electronic signs;

DRAFT

- 1 F. Moving signs;
- 2 G. Snipe signs;
- 3 H. Obscene signs;
- 4 I. Pennants; and
- 5 J. Balloons, dancing tubes, and other tethered inflatable promotional devices.

Section 30-9.4. General Requirements for All Signs.

- 7 A. Substitution of message. Any sign used in conformance with the provisions of this sign code may at
8 the option of the owner contain either a commercial or noncommercial message.
- 9 B. Location and general regulations.
 - 10 1. Signs shall not be located in such a manner as to obstruct the vision of pedestrians or motorists,
11 including obstructions within the vision triangle. However, signs may be located at least eight
12 feet above the highest crown of any adjacent street when such sign is mounted upon a sign
13 support structure that does not exceed eight inches in diameter.
 - 14 2. Signs shall not be located in such a manner as to obstruct ingress/egress through any door or
15 window required or designed for ingress/egress to any building, and shall not obstruct or be
16 attached to a fire escape.
 - 17 3. Signs shall not be located in or on any public right-of-way.
 - 18 4. Signs shall not use the words "Stop," "Look," "Drive in," "Danger" or any similar word, phrase,
19 symbol or character within 10 feet of a public right-of-way or 200 feet of a traffic control device.
- 20 C. Illumination.
 - 21 1. Only permanent signs may be illuminated. Temporary signs shall not be illuminated.
 - 22 2. Signs may be illuminated with a steady light, but shall not be illuminated to give the effect of
23 blinking, flashing, or moving.
 - 24 3. Sign illumination shall not produce glare or any condition that constitutes a hazard to traffic.
 - 25 4. Sign illumination shall not use bare-bulb illumination, and shall minimize light pollution and
26 meet the light trespass requirements of the Land Development Code.
 - 27 5. Colored lights. Colored lights shall be designed to prevent confusion with traffic control signals.
28 No sign located within 10 feet of public right-of-way or within 200 feet of traffic control signals
29 shall contain red or green lights.
 - 30 6. Strip lighting.
 - 31 a. Shall be no greater than one inch in diameter.
 - 32 b. Shall not be directed towards any property located within 200 feet of the strip lighting that
33 is zoned residential district or zoned planned development district with predominantly
34 residential use.
 - 35 c. Shall obtain all necessary electrical permits.
 - 36 d. If not separated from a sign by at least two feet, it shall be included in the calculation of
37 allowable signage area.

DRAFT

1 D. Measurement.

- 2 1. Sign structure height. The height of a freestanding sign structure shall be measured vertically
3 from the established average grade directly below the sign structure to the elevation of the
4 highest point of the sign structure.
- 5 2. Distance between signs. The minimum required distance between signs shall be measured from
6 the closest parts of any two sign areas.
- 7 3. Sign area. The sign area shall be calculated as defined and as illustrated in the following:

8

TYPES OF SIGNS



PROJECTING SIGNS

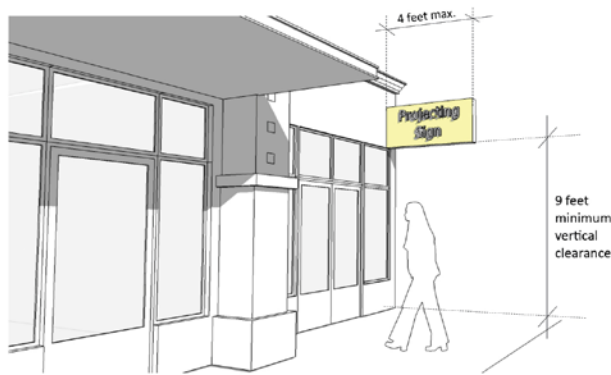

CANOPY SIGN

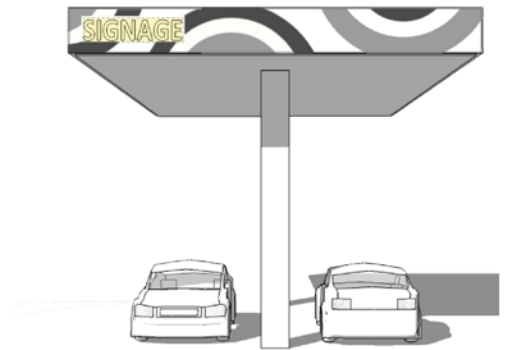

Canopy signs shall not project above or below the roof and fascia band of the canopy. Do not include decorative graphics in the sign area calculation.

FREESTANDING POLE SIGNS

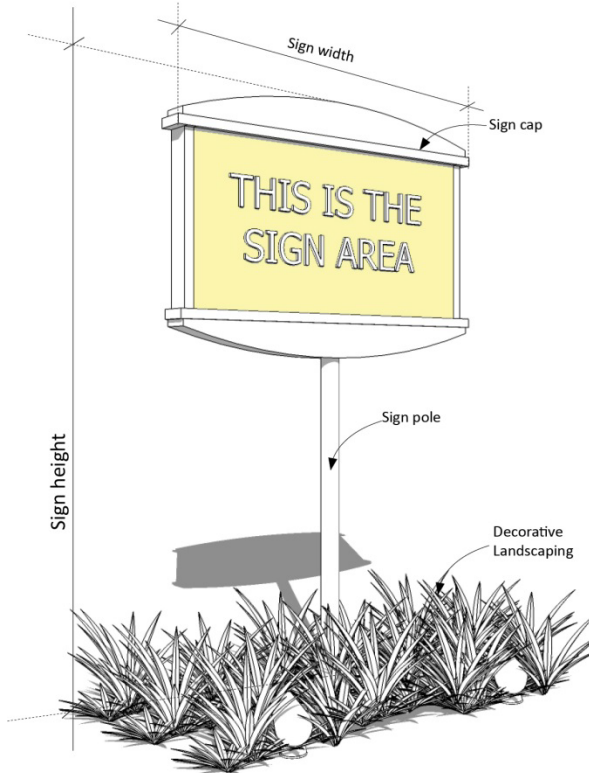

Decorative elements on the sign structure shall not be included in the sign area unless they contain a sign copy.

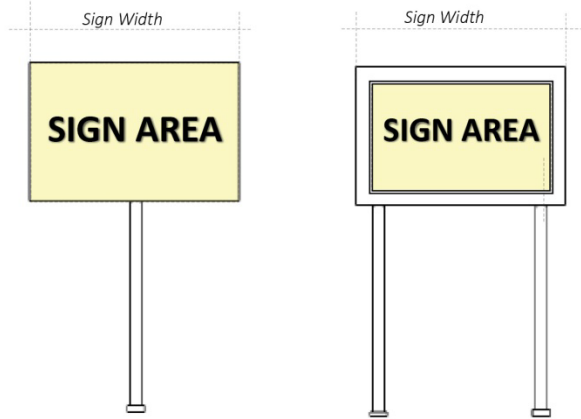

Sign area may or may not be defined by a boundary.

- Where a sign contains a defining boundary within the sign structure, calculate sign area by taking the area of an imaginary rectangle around the boundary.
- Where sign area is not defined by a boundary within the sign structure, calculate sign area by taking the area of an imaginary rectangle around the outer edges of the sign elements.

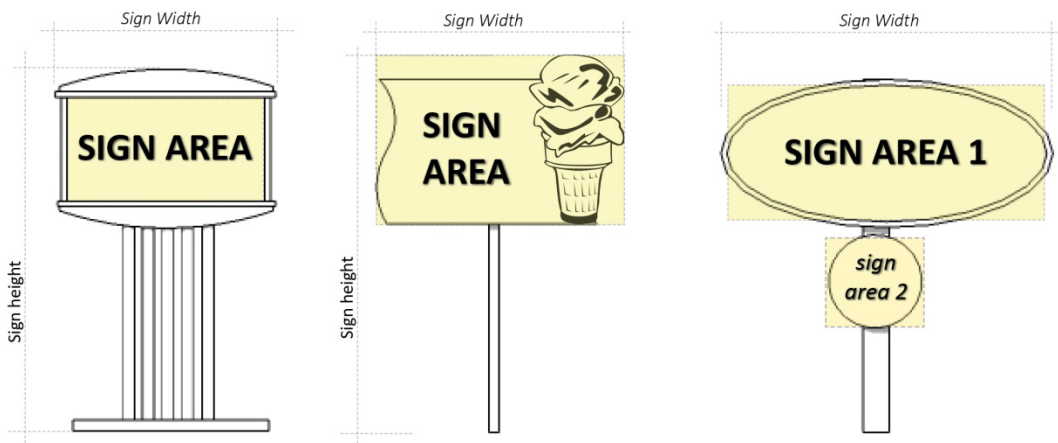

FREESTANDING MONUMENT SIGNS

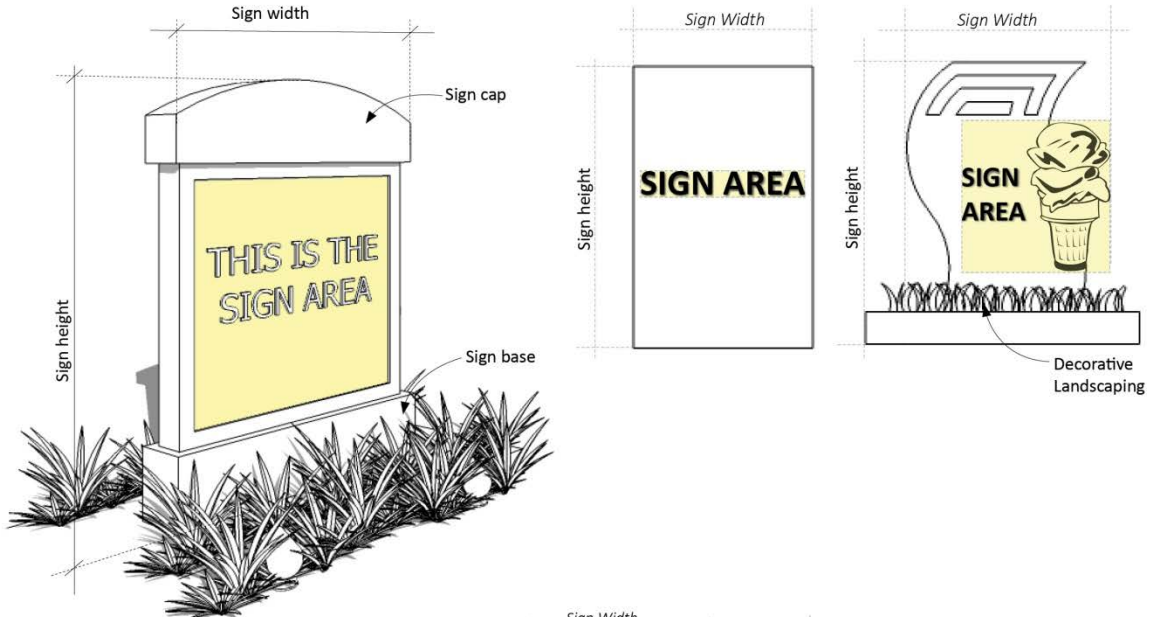

Decorative landscaping shall not be included in sign area unless they contain a sign copy.

Sign area may or may not be defined by a boundary.

- Where a sign contains a defining boundary within the sign structure, calculate sign area by taking the area of an imaginary rectangle around the boundary.
- Where sign area is not defined by a boundary within the sign structure, calculate sign area by taking the area of an imaginary rectangle around the outer edges of the sign elements.

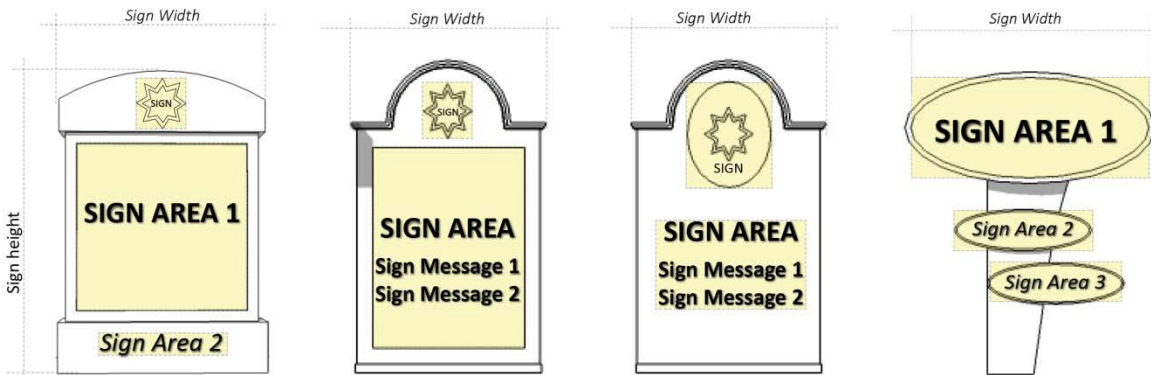
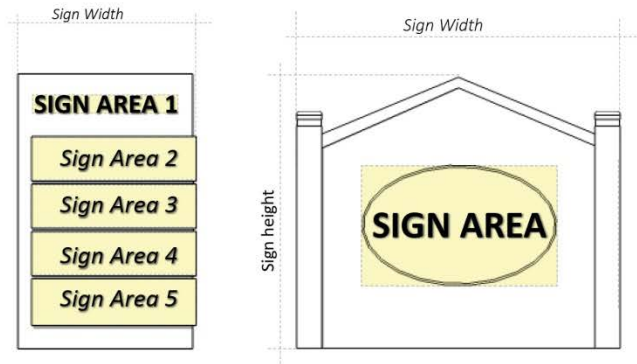

DRAFT

SIGN FACES

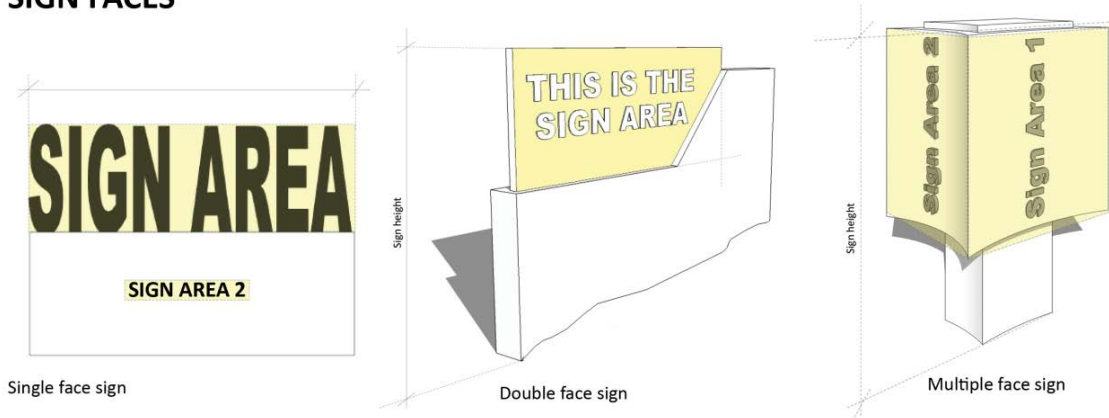

1

CALCULATING SIGN AREA FOR BUILDING MOUNTED SIGNS



Calculate sign area by taking the area of an imaginary rectangle panel around panel surrounding sign background



Calculate sign area by taking the area of an imaginary rectangle panel around outer edges of channel letters

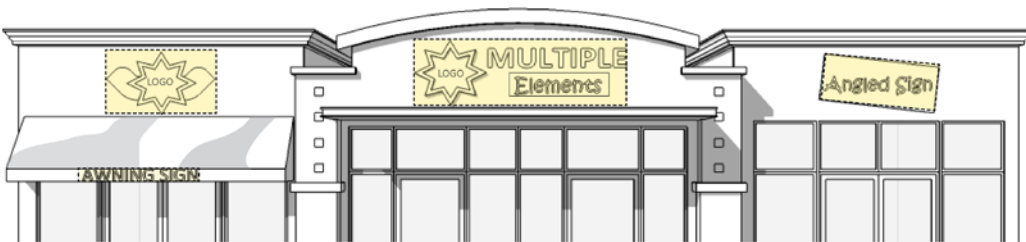

Calculate sign area by taking the area of an imaginary rectangle panel around outer edges of the sign elements

2

DRAFT

1
2
3
4
5
6
7

Section 30-9.5. Allowable Signs – No Permit Required.

The following signs may be used without the need to first obtain a sign permit from the city, provided that such signs meet the applicable regulations in this section and Section 30-9.4 and have no electrical parts or usage unless ULI listed. Any signage allowable per this section is in addition to any signage otherwise allowable under this sign code.

A. Temporary signs.

<u>Sign location</u>	<u>Max number</u>	<u>Max duration</u>	<u>Max sign area (sq. feet)</u>	<u>Max sign structure height (feet)</u>	<u>Setback from side property line (feet)</u>
<u>Single-family residential property</u>	--	<u>180 calendar days</u>	<u>6</u>	<u>4</u>	<u>10</u>
<u>Multi-family residential property</u>	<u>6 per property</u>	<u>180 calendar days</u>	<u>6</u>	<u>8</u>	<u>10</u>
<u>Nonresidential property</u>	<u>4 per property</u>	<u>180 calendar days</u>	<u>32</u>	<u>8</u>	<u>10</u>

8 1. Events. Signs pertaining to an event shall be removed no later than 10 calendar days after the
9 event. As used in this section, “event” shall mean an occurrence, happening, activity, or series
10 of activities, specific to an identifiable time and place, if referenced on the sign itself or
11 reasonably determined from all circumstances by the enforcing official.

12 **B. Signs necessary to preserve life and prevent serious injury.**

<u>Sign type</u>	<u>Max number</u>	<u>Max sign area (sq. feet)</u>	<u>Max sign structure height (feet) (freestanding signs)</u>	<u>Notes</u>
<u>Address, identification, contact information</u>	<u>1 per street frontage</u>	<u>6</u>	<u>6</u>	<u>Characters shall not exceed eight inches in height for nonresidential uses.</u>
<u>Direct/guide traffic and parking (building identification may be included)</u>	<u>N/A</u>	<u>6</u>	<u>6</u>	<u>Example: Parking, entrance, exit, one-way, service, etc.</u>
<u>General safety/caution or to prohibit trespassing</u>	<u>N/A</u>	<u>4</u>	<u>6</u>	<u>Non-illuminated.</u>

DRAFT

<u>Safety/caution of the location and direction of underground utility lines</u>	<u>1 per block face or every 200 feet, whichever is less</u>	<u>0.5</u>	<u>3</u>	<u>Non-illuminated. Signs should not be clustered at street corners unless required because of a directional change to the underground line.</u>
<u>On hospital grounds, directing the public to the emergency room—Wall-mounted</u>	<u>1 per street frontage</u>	<u>Lesser of 10% of the wall or 100 sq. ft.</u>	<u>N/A</u>	<u>At least one sign shall be located on front face of emergency room entry. May include directional arrows. May only read "EMERGENCY" or similar text.</u>
<u>On hospital grounds, directing the public to the emergency room—Freestanding</u>	<u>1 per street frontage or entrance</u>	<u>24</u>	<u>10</u>	

1

2 *C. Miscellaneous signs.*

<u>Sign type or location</u>	<u>Max number</u>	<u>Max sign area (sq. feet)</u>	<u>Max sign structure height (feet)</u>	<u>Notes</u>
<u>Non-illuminated signs, including window signs and excluding flexible banner signs</u>	<u>1</u>	<u>12</u>	<u>N/A</u>	<u>Signage in excess of this standard shall be counted as part of the building-mounted signage allowance.</u>
<u>Signs on the body of vending machines, gasoline pumps, ice vending equipment, or similar public-serving amenities</u>	<u>N/A</u>	<u>6</u>	<u>N/A</u>	
<u>Signs on an umbrella attached to a table at an outdoor eating place or alcoholic beverage establishment</u>	<u>N/A</u>	<u>N/A</u>	<u>N/A</u>	
<u>Decorative vertical pole banners</u>	<u>N/A</u>	<u>18</u>	<u>N/A</u>	<u>Pole must be lawfully permitted and serve a dual purpose such as light poles.</u>

DRAFT

<u>Signs that are a permanent architectural feature of the building or structure</u>	<u>N/A</u>	<u>N/A</u>	<u>N/A</u>	<u>Such as a cornerstone or other identifying letters carved into or embossed on the building, provided such letters are not illuminated apart from the building, are not made of a reflective material and do not contrast in color with the building.</u>
<u>Pedestrian-oriented sign, under-canopy</u>	<u>1</u>	<u>4</u>	<u>N/A</u>	<u>Permanently attached. Minimum 9-foot vertical clearance under sign. Not internally illuminated.</u>
<u>Pedestrian-oriented sign, pedestal</u>	<u>Either 1 pedestal sign or 1 message board sign</u>	<u>2.25</u>	<u>5</u>	<u>Permanently attached to ground. Outside of right-of-way and any pedestrian walkway. May be internally illuminated.</u>
<u>Pedestrian-oriented sign, message board</u>	<u>Either 1 pedestal sign or 1 message board sign</u>	<u>6</u>	<u>N/A</u>	<u>Permanently attached to wall, door, or window. May be mounted in a protective frame up to 6 inches deep. May be internally illuminated.</u>

1

2 **D. Flags.**

<u>Sign location</u>	<u>Max flagpole height (feet)</u>
<u>Residential districts</u>	<u>25'</u>
<u>Nonresidential districts</u>	<u>30'</u>

- 3 1. The vertical dimension of the flag shall be a maximum of 20% of the height of the flagpole.
- 4 2. A flagpole may be freestanding or building-mounted. Freestanding flagpoles shall be set back at
- 5 least 10 feet from any property line.

6 **E. Murals and other works of art.** Murals and other works of art, as defined in Chapter 5.5 of this Code

7 of Ordinances, shall not require a sign permit provided that they meet any applicable regulations in

8 Section 30-9.4 and have no electrical parts or usage unless ULI listed. Any part of a mural or work of

9 art that contains a commercial message shall not be included within the allowance of this subsection

10 and therefore shall comply with any applicable provisions of this sign code.

11 **Section 30-9.6. Interim Signs and Street Banners.**

12 **A. Interim signs.** Prior to or in conjunction with an owner or designated agent submitting an

13 application for a sign permit in accordance with Section 30-9.7, the owner or designated agent may

DRAFT

1 apply to the City Manager or designee, at no fee, for an interim sign permit to allow for the
2 immediate and temporary use of the signage area allotments provided for in Section 30-9.7. Interim
3 sign permits shall expire one year after issuance or when a corresponding sign is permitted and
4 installed in accordance with Section 30-9.7, whichever occurs first, and may be extended for good
5 cause. Interim signs shall be removed within three calendar days after expiration of the interim sign
6 permit.

7 B. *Street banners.* No sign may be erected, constructed, or maintained along or across any public
8 streets, except across-street and vertical pole banners as permitted over or along certain streets
9 designated by the City Manager and the General Manager for Utilities. An application shall be filed
10 with the City Manager or designee together with a banner installation fee as prescribed by the
11 General Manager for Utilities to allow full cost recovery to the city. The following regulations shall
12 apply:

- 13 1. Banners shall relate to an event that will be open to the general public and that is scheduled to
14 occur within the city or unincorporated Alachua County;
- 15 2. Banners shall not contain any commercial message, any phone numbers or addresses, or any
16 traffic directions or traffic signage that may cause a traffic or pedestrian hazard; and
- 17 3. The city will install street banners no more than 14 calendar days prior to the event and will
18 remove them no later than seven calendar days following the event.

Section 30-9.7. Allowable Signs – Permit Required.

20 A. *Permit Required.* With the exception of the signage provided for in Section 30-9.5 and Section 30-
21 9.6, it shall be unlawful to use, erect, maintain, alter, or extend any new or existing sign without first
22 obtaining a sign permit from the city in accordance with this section. The owner or designated
23 agent shall apply for a sign permit by submitting an application to the City Manager or designee on a
24 form provided by the city, together with the applicable sign permit fee.

25 1. *Review period.* The City Manager or designee shall grant or deny a sign permit application
26 within 30 calendar days from the date a completed application and payment of the permit fee
27 was submitted to the city. If the City Manager or designee fails to take action by either granting
28 or denying a sign permit application within this specified period, it shall be deemed approved.

29 2. *Review criteria.*

30 a. If the City Manager or designee determines that the application meets the requirements of
31 this sign code and all building, electrical, and other applicable regulations of the city, the City
32 Manager or designee shall approve the application and issue the sign permit contingent on
33 an inspection after installation/alteration.

34 b. If the City Manager or designee determines that the application fails to meet one or more
35 requirements of this sign code or building, electrical, or other applicable regulations of the
36 city, the City Manager or designee shall deny the application and shall make a written report
37 of the denial and the reasons therefore. A copy of the report shall be sent by certified mail
38 to the applicant.

39 c. If the application is denied, the applicant may submit an amended application within 15
40 calendar days of the date posted on the notice of denial without additional cost. The City
41 Manager or designee shall grant or deny an amended application within 30 calendar days of

DRAFT

1 receipt. If the City Manager or designee fails to take action by either granting or denying an
 2 amended application within this specified period, it shall be deemed approved.

3 **B. Building-mounted, permanent.** Building-mounted sign allowance may be used by a combination of
 4 wall, window, mansard, parapet, awning, marquee, or canopy signs, and shall not exceed the
 5 maximum sign area established below. Except where otherwise specifically provided, permanent
 6 building-mounted signs may be permitted as follows:

<u>Sign location</u>	<u>Max number</u>	<u>Max sign area (sq. feet)</u>
<u>Residential districts</u>	<u>1 – Principal use</u> <u>1 – Accessory use (if applicable)</u>	<u>24 – Principal use</u> <u>18 – Accessory use</u>
<u>Nonresidential districts – development two stories or less</u>	<u>2 per tenant</u>	<u>Length of leased space × 1.5, up to 200 max aggregate per tenant</u>
	<u>1 for each exterior building wall that is part of a tenant’s space</u>	<u>50 - second side</u> <u>24 - third side</u> <u>24 - fourth side</u>
	<u>1 directional</u>	<u>6</u>
<u>Nonresidential districts – development greater than two stories</u>	<u>2 (3 if primary frontage greater than 500 linear feet), plus 1 for each exterior wall</u>	<u>300 max aggregate</u>
	<u>2 per tenant, within the building sign band</u>	<u>Length of leased space × 1.5, up to 100 max aggregate per tenant</u>
	<u>1 directional</u>	<u>6</u>
<u>Parking garage</u>	<u>1 per street frontage</u>	<u>75 max aggregate</u>
	<u>2 per tenant</u>	<u>Length of leased space × 1.5, up to 100 max aggregate per tenant</u>
	<u>2 directional</u>	<u>6</u>

- 7 1. **Projecting.** Signs shall not extend horizontally beyond the edges of the awning, marquee,
 8 mansard, or parapet to which they are attached or from which they are suspended and no more
 9 than four feet horizontally from the wall. Signs shall not project vertically above the roofline.
 10 Such signs under which a pedestrian walkway passes shall have at least a nine-foot vertical
 11 clearance.
- 12 2. **Canopy.** Any signage on a canopy shall be considered, and included within the allowable
 13 allotment of, building-mounted signage.
- 14 3. **Wall.** Where a wall supporting a building-mounted sign is less than 12 inches from a public right-
 15 of-way, the wall sign may project over the right-of-way, provided it does not project more than
 16 12 inches from the wall.

DRAFT

- 1 C. Freestanding, permanent. Except where otherwise specifically provided, permanent freestanding
 2 signs may be permitted as follows. However, permanent freestanding signs shall not be permitted
 3 on single-family residential properties.

Sign location	Max number (may choose either monument or pole)	Max sign area (sq. feet)	Max sign structure height (feet)	Max sign structure width (feet)
<u>Residential districts</u>	<u>1</u>	Monument: • <u>32</u> Pole: • <u>24</u>	<u>8</u>	<u>12</u>
<u>Nonresidential districts</u>	<u>1 primary frontage</u>	Monument: • <u>32 if frontage up to 50 ft.</u> • <u>40 if frontage 51-100 ft.</u> • <u>Frontage length x 0.5 (up to 120 max) if frontage greater than 100 ft.</u> Pole: • <u>24 if frontage up to 50 ft.</u> • <u>32 if frontage 51-100 ft.</u> • <u>Frontage length x 0.4 (up to 96 max) if frontage greater than 100 ft.</u>	<u>10</u>	<u>15</u>
	<u>1 additional primary frontage if greater than 500 linear feet</u>	Monument: • <u>75</u> Pole: • <u>50</u>	<u>10</u>	<u>15</u>
	<u>1 secondary frontage</u>	Monument: • <u>30</u> Pole: • <u>24</u>	<u>8</u>	<u>12</u>
	<u>1 outparcel</u>	Monument: • <u>38 if frontage 151-200 ft.</u> • <u>58 if frontage greater than 200 ft.</u> Pole: • <u>32 if frontage 151-200 ft.</u> • <u>48 if frontage greater than 200 ft.</u>	<u>8</u>	<u>12</u>
	<u>Unlimited directional for developments with greater than 300,000 square feet of floor</u>	<u>50</u> • <u>single-occupancy developments shall be</u>	<u>6</u>	<u>12</u>

DRAFT

	<u>area; shall be located at least 100 feet from any public right-of-way</u>	<u>limited to two square feet per individual sign face</u>		
<u>Identification</u>		<i>Residential development:</i> <ul style="list-style-type: none"> • <u>16 for primary entrance if less than 6 units</u> • <u>24 for primary entrance if 6 or more units</u> • <u>16 for each additional entrance</u> 		
		<i>Minor subdivision:</i> <ul style="list-style-type: none"> • <u>18</u> 		
	<u>1 per entrance; may be one double-sided sign or two single-faced signs on either side of an entrance</u>	<i>Nonresidential subdivision:</i> <ul style="list-style-type: none"> • <u>6 per lot (up to 115 max for monument signs or 96 max for pole signs)</u> 	<u>8</u>	<u>12</u>

- 1 1. Spacing and setback. Shall be located at least 50 feet from any other permanent freestanding
- 2 sign, and shall have a minimum setback of 10 feet from any front or side property line.
- 3 D. I-75 corridor signs.
- 4 1. For purposes of this subsection, I-75 corridor signage shall be restricted to permitted uses in
- 5 nonresidential districts that are located within ¼ mile of the centroid of an I-75 interchange with
- 6 any arterial roadway.
- 7 2. In addition to signage otherwise allowable per this sign code, an additional freestanding sign
- 8 with a maximum sign structure height of 18 feet shall be allowed on a development (including
- 9 outparcels), provided that the sign area of such sign in combination with other permitted signs
- 10 on the development does not exceed a maximum sign area of 300 square feet. Such sign shall be
- 11 readily visible from I-75. The location of this sign shall not be limited to properties actually
- 12 abutting I-75; however, no I-75 corridor sign shall be located on any frontage where the
- 13 adjacent or facing properties are designated single-family on the future land use map.
- 14 3. Height extension. An owner or designated agent may apply for a height extension to allow for an
- 15 I-75 corridor sign with a maximum sign structure height greater than 18 feet. However, under no
- 16 circumstances may a sign structure exceed a height of 90 feet. Applications for a height
- 17 extension shall be accompanied by a fee in the amount established for a variance as set forth in
- 18 Appendix A. The City Plan Board shall review height extension applications and shall approve or
- 19 deny the application based upon the following special considerations. The city plan board shall
- 20 approve an application for a height extension only when the applicant proves each of the
- 21 following requirements:
- 22 a. A registered engineer certifies or other reliable documentary evidence proves that, due to
- 23 special conditions and circumstances relative to topography, vegetation or the built
- 24 environment, a sign structure with a height of 18 feet or less cannot be seen by motorists on
- 25 I-75 at a distance of ¼ mile from the nearest exit ramp;
- 26 b. The height extension requested is the minimum necessary to achieve such visibility;

DRAFT

- c. The circumstances and/or special conditions do not result from the actions of the applicant;
- d. The height extension will have general compatibility and harmony with the uses and structures on adjacent and nearby properties; and
- e. The sign otherwise complies with all applicable regulations of this sign code.

The City Plan Board may prescribe appropriate conditions and safeguards to ensure the structural integrity and safety of the sign and to landscape and buffer the sign structure to ensure compatibility and harmony with the uses and structures on adjacent and nearby properties.

E. Gainesville Regional Airport.

<u>Sign Type</u>	<u>Max number</u>	<u>Max sign area (sq. feet)</u>	<u>Max sign structure height (feet)</u>	<u>Notes</u>
<u>Freestanding, permanent</u>	4	<u>360 max aggregate for all freestanding signs</u>	<u>10</u>	
<u>Building-mounted, permanent</u>				<u>As approved by the Gainesville Alachua County Regional Airport Authority (GACRAA); no city approval required</u>
<u>Directional</u>				<u>As approved by the Gainesville Alachua County Regional Airport Authority (GACRAA); no city approval required</u>

Section 30-9.8. Sign Maintenance.

- A. All signs and sign structures regulated by this chapter, including any supports, braces, guys and anchors, electrical parts, lighting fixtures, and all painted and display areas shall be maintained to present a neat, clean appearance and maintained in a safe condition. Painted areas and sign surfaces shall be kept in good condition, and illumination, if provided, shall be maintained in safe and good working order.
- B. Weeds and grass shall be kept cut in front of, behind, underneath, and around the base of freestanding signs for a distance of 10 feet, and no rubbish or debris shall be permitted under or near such signs.
- C. Any sign that becomes dilapidated, run down, or a safety hazard shall be repaired or removed by the owner or designated agent.

Section 30-9.9. Nonconforming Signs.

Any sign that does not comply with the requirements of this chapter, but for which a permit has previously been issued by either the city or Alachua County, shall be deemed legally nonconforming. The owner of any legally nonconforming sign or the owner of any property upon which such sign is located shall bear the burden of proving that such sign is a legally nonconforming sign. All other signs that do

DRAFT

- 1 not comply with the requirements of this chapter and that are not legally nonconforming shall
2 immediately be removed or brought into compliance with this chapter.
- 3 A. All legally nonconforming signs shall be allowed to remain as originally permitted.
- 4 B. Reasonable repair and maintenance necessary to keep a legally nonconforming sign in a good state
5 of repair is allowed, and may include but is not limited to:
- 6 1. Changing light bulbs, neon, or other light source;
7 2. Changing the face of a cabinet sign, or other modification that only involves a change of copy;
8 3. Replacing cladding or other components that hold a sign face in place;
9 4. Painting, cleaning, and other maintenance activities that do not affect the type, height, or size of
10 the sign structure; and
11 5. Repairing electrical components.
- 12 C. Reasonable repair and maintenance does not include, by way of example and not limitation:
- 13 1. Any modification that changes the structure or type of structure, such as conversion of a
14 wooden sign structure to a metal sign structure, or otherwise prolongs the life of the sign
15 structure;
- 16 2. Any modification, including the addition of embellishments, that changes the sign area or the
17 height above ground level; and
- 18 3. Any modification that adds internal or external illumination, or increases the existing
19 illumination.
- 20 D. A legally nonconforming sign shall be removed or brought into compliance with this sign code if any
21 of the following conditions apply:
- 22 1. The sign becomes damaged, destroyed or deteriorated by any means to the extent that it
23 requires more than reasonable repair and maintenance, as described above, or if the cost of
24 renovation or repair exceeds 50% of the replacement cost of the sign;
- 25 2. The principal structure on the parcel or parcels is demolished or requires renovations the costs
26 of which exceed 50% of the assessed value of the structure; or
- 27 3. The nonconforming sign is moved for any reason.
- 28 E. Historic signs. A sign that has been added to the local historic register shall not be considered a
29 nonconforming sign and shall be exempt from the limitations of this subsection.

Section 30-9.10. Enforcement.

- 31 A. Duties of enforcing official. The City Manager or designee shall be the enforcing official. The
32 enforcing official is charged with the duty of administering and securing compliance with the
33 provisions of this sign code. In furtherance of this responsibility, the enforcing official shall:
- 34 1. Make such inspections as may be necessary to bring about the purpose and intent of this sign
35 code and initiate appropriate action to bring about compliance if such inspection discloses any
36 instance of noncompliance;
- 37 2. Investigate thoroughly any complaints of alleged violations of this sign code, and indicate clearly
38 in writing as a public record in his/her office the disposition made of such complaints;

DRAFT

- 1 3. Order in writing as set out below the remedy of all conditions or all violations of the sign code
- 2 found to exist in or on any premises;
- 3 4. State in the violation order a time limit for compliance; and
- 4 5. Request the assistance of the City Attorney in taking appropriate legal action upon the failure of
- 5 the responsible party to comply with such violation order by the time specified therein.
- 6 B. Right of entry. The enforcing official or his/her agent is authorized and directed to lawfully enter in
- 7 and upon all premises at reasonable times to determine their condition insofar as the provisions of
- 8 this sign code are applicable.
- 9 C. Contents of notice of violation. Whenever the enforcing official determines that a violation of this
- 10 sign code exists, the official is authorized to issue a citation pursuant to Section 2-337. Time for
- 11 compliance shall be as follows:
- 12 1. Temporary and prohibited signs. For all signs that are either temporary or prohibited as
- 13 specified in this sign code, the time may not be less than one hour nor more than 24 hours from
- 14 the time of such written notice. However, any condition found to exist in violation of this sign
- 15 code that constitutes a hazard to the public safety shall be required to be abated immediately.
- 16 2. All other signs. For all other signs, the time may not be less than 10 calendar days nor more than
- 17 90 calendar days from the date of such written notice. However, any condition found to exist in
- 18 violation of this sign code that constitutes a hazard to the public safety shall be required to be
- 19 abated immediately.
- 20 D. Unauthorized signs in right-of-way. Any sign placed in the public right-of-way in violation of this sign
- 21 code shall be deemed to be abandoned and may be removed immediately by an enforcing official or
- 22 agent. Any sign so removed may be disposed of by the city without notice or compensation. This
- 23 removal shall not preclude prosecution or imposition of penalties for violation of this sign code.
- 24 E. The enforcing official or agent may cause any sign that is a hazard or poses immediate peril to
- 25 persons or property to be removed immediately at the expense of the owner, lessee or other person
- 26 having beneficial use of the sign, or the owner or lessee of the land upon which the sign is located.

27

28 **SECTION 3.** It is the intent of the City Commission that the provisions of Sections 1 and 2 of this

29 ordinance shall become and be made a part of the Code of Ordinances of the City of Gainesville,

30 Florida, and that the sections and paragraphs of the Code of Ordinances may be renumbered or

31 relettered in order to accomplish such intent.

32 **SECTION 4.** If any word, phrase, clause, paragraph, section, or provision of this ordinance or

33 the application hereof to any person or circumstance is held invalid or unconstitutional, such

34 finding shall not affect the other provisions or applications of this ordinance that can be given

DRAFT

1 effect without the invalid or unconstitutional provision or application, and to this end the
2 provisions of this ordinance are declared severable.

3 **SECTION 5.** All ordinances or parts of ordinances in conflict herewith are to the extent of such
4 conflict hereby repealed.

5 **SECTION 6.** This ordinance shall become effective immediately upon adoption.

6

7 **PASSED AND ADOPTED** this _____ day of _____, 2018.

8

9

10

11

12

13

14

15

16

17

18

19

20

21

22 This ordinance passed on first reading this _____ day of _____, 2018.

23

24 This ordinance passed on second reading this _____ day of _____, 2018.

25

26

LAUREN POE
MAYOR

Attest:

Approved as to form and legality:

OMICHELE GAINEY
CLERK OF THE COMMISSION

NICOLLE M. SHALLEY
CITY ATTORNEY