

LEGISLATIVE #

160679A

ORDINANCE NO. 160679

An ordinance of the City of Gainesville, Florida, amending the Master Signage Plan that regulates signage within the Butler Development, a Planned Development (PD) zoning district that consists of approximately 267 acres generally located north of SW Archer Road, south of SW 24th Avenue, east of SW 40th Boulevard, and west of SW 34th Street; providing for enforcement; providing a severability clause; providing a repealing clause; and providing an immediate effective date.

WHEREAS, the Butler Development is a private development consisting of approximately 267 acres within the City of Gainesville that is generally located north of SW Archer Road, south of SW 24th Avenue, east of SW 40th Boulevard, and west of SW 34th Street; and

WHEREAS, on November 21, 2013, the City Commission adopted Ordinance No. 121108 and rezoned Butler Development to Planned Development District (PD), which is a zoning category that allows for landowners or developers to submit unique proposals that are not addressed or otherwise provided for in the zoning districts and land development regulations established by the City of Gainesville Land Development Code; and

WHEREAS, Section 163.3164(26), Florida Statutes, defines “land development regulations” as ordinances enacted by governing bodies for the regulation of any aspect of the development of land and shall specifically include any local government zoning, rezoning, subdivision, building construction, and sign regulations; and

WHEREAS, Section 163.3202(2), Florida Statutes, requires each municipality to adopt by ordinance and enforce certain land development regulations, which shall include the regulation of signage amongst other land development regulations; and

1 **WHEREAS**, Section 30-214 of the Land Development Code specifies certain land
2 development regulations that a PD zoning ordinance may include, such as a unified signage plan
3 that will regulate signage within the PD in a unique and innovative manner that is not provided
4 for in the sign regulations in the Land Development Code but is nevertheless consistent with and
5 promoted by the City of Gainesville Comprehensive Plan; and

6 **WHEREAS**, PD Ordinance No. 121108 includes a provision that allows Butler
7 Development to submit a Master Signage Plan that will regulate signage within the Butler
8 Development, subject to review and approval by the City Commission (*see* Exhibit “C” to
9 Ordinance No. 121108, page 19 of 47, #7); and

10 **WHEREAS**, on January 15, 2015, the City Commission adopted Ordinance No. 140501
11 to adopt a Master Signage Plan regulating signage within the Butler Development; and

12 **WHEREAS**, by initiation of the owners of Butler Development, this ordinance amends
13 the adopted Master Signage Plan; and

14 **WHEREAS**, the City Plan Board, which acts as the Local Planning Agency pursuant to
15 Section 163.3174, Florida Statutes, held a public hearing on January 26, 2017, and voted to
16 recommend that the City Commission approve this amendment to the Butler Development
17 Master Signage Plan; and

18 **WHEREAS**, at least 10 days’ notice has been given once by publication in a newspaper
19 of general circulation notifying the public of this proposed ordinance and of public hearings in
20 the City Hall Auditorium located on the first floor of City Hall in the City of Gainesville; and

1 **WHEREAS**, public hearings were held pursuant to the notice described above at which
2 hearings the parties in interest and all others had an opportunity to be and were, in fact, heard;
3 and

4 **WHEREAS**, the City Commission recognizes that signs may present a safety hazard by
5 distracting motorists, pedestrians and other members of the public and may affect the aesthetic
6 qualities and economic vitality of the community, and that these concerns are of a substantial
7 interest to the City of Gainesville; and

8 **WHEREAS**, the City Commission finds that the signage regulations provided in the
9 Butler Development Master Signage Plan are consistent with and promote the Comprehensive
10 Plan and that such signage regulations are reasonable and narrowly tailored to directly preserve
11 and protect the health, safety, welfare, and general well-being of citizens by promoting public
12 safety, economic vitality, and aesthetic qualities in the City of Gainesville.

13 **NOW, THEREFORE, BE IT ORDAINED BY THE CITY COMMISSION OF THE**
14 **CITY OF GAINESVILLE, FLORIDA:**

15 **SECTION 1.** The Butler Development Master Signage Plan, attached to this ordinance
16 as **Exhibit A** and incorporated herein by reference as if set forth in full, is adopted to regulate
17 signage within the Butler Development and shall replace and supersede the signage regulations
18 provided in PD Ordinance No. 121108 (pages 18-19 of 47 in Exhibit C to Ordinance No.
19 121108) and in The Butler Development Master Signage Plan that was adopted in Ordinance No.
20 140501. All signage within the Butler Development shall meet the signage regulations set forth
21 in the City of Gainesville Land Development Code in effect at the time of application for a sign
22 permit, except as expressly provided by the Butler Development Master Signage Plan attached to

1 this ordinance as **Exhibit A**.

2 **SECTION 2.** Any person who violates any provision of this ordinance shall be deemed
3 guilty of a municipal ordinance violation and shall be subject to the enforcement provisions
4 provided in the City of Gainesville Land Development Code.

5 **SECTION 3.** If any word, phrase, clause, paragraph, section or provision of this
6 ordinance or the application hereof to any person or circumstance is held invalid or
7 unconstitutional, such finding shall not affect the other provisions or applications of this
8 ordinance that can be given effect without the invalid or unconstitutional provision or
9 application, and to this end the provisions of this ordinance are declared severable.

10 **SECTION 4.** Ordinance No. 140501 is hereby superseded in its entirety and is hereby
11 repealed on the effective date of this ordinance. Except as expressly modified or superseded
12 herein, Ordinance No. 121108 shall remain in full force and effect. In the event of conflict or
13 inconsistency between the provisions of Ordinance No. 121108 and this ordinance, this ordinance
14 shall govern and prevail. All other ordinances or parts of ordinances in conflict herewith are to
15 the extent of such conflict hereby repealed

16 **SECTION 5.** This ordinance shall become effective immediately upon adoption.

17

18 **PASSED AND ADOPTED** this _____ day of _____, 2017.

19
20
21
22
23
24
25
26

LAUREN POE
MAYOR

Attest:

Approved as to form and legality:

1
2
3
4
5
6
7
8

KURT M. LANNON
CLERK OF THE COMMISSION

NICOLLE M. SHALLEY
CITY ATTORNEY

This ordinance passed on first reading this ____ day of _____, 2017.

This ordinance passed on second reading this ____ day of _____, 2017.

EXHIBIT “A” TO ORDINANCE NO. 160679

**BUTLER DEVELOPMENT
MASTER SIGNAGE PLAN**

TABLE OF CONTENTS

<u>SECTION</u>	<u>PAGE</u>
I. SIGN LOCATION MAP	3
II. GENERAL SIGNAGE STANDARDS	4
III. LANDMARK SIGN	5
IV. PROJECT ENTRY SIGNS	
A. TYPE 1	7
B. TYPE 2	8
V. MONUMENT SIGNS	9
VI. OUTPARCEL SIGNS	10
VII. PROJECT DIRECTIONAL SIGNS	11
VIII. VEHICULAR DIRECTIONAL SIGNS.....	12
IX. POLE BANNERS.....	13
X. WALL SIGNS	14
XI. AWNING, UNDER-CANOPY/PROJECTING, BLADE, AND MARQUEE SIGNS	16
XII. PEDESTRIAN SIGNS	17
XIII. TEMPORARY SIGNS.....	18
XIV. ARCHER ROAD SIGNAGE.....	19

I. Sign Location Map

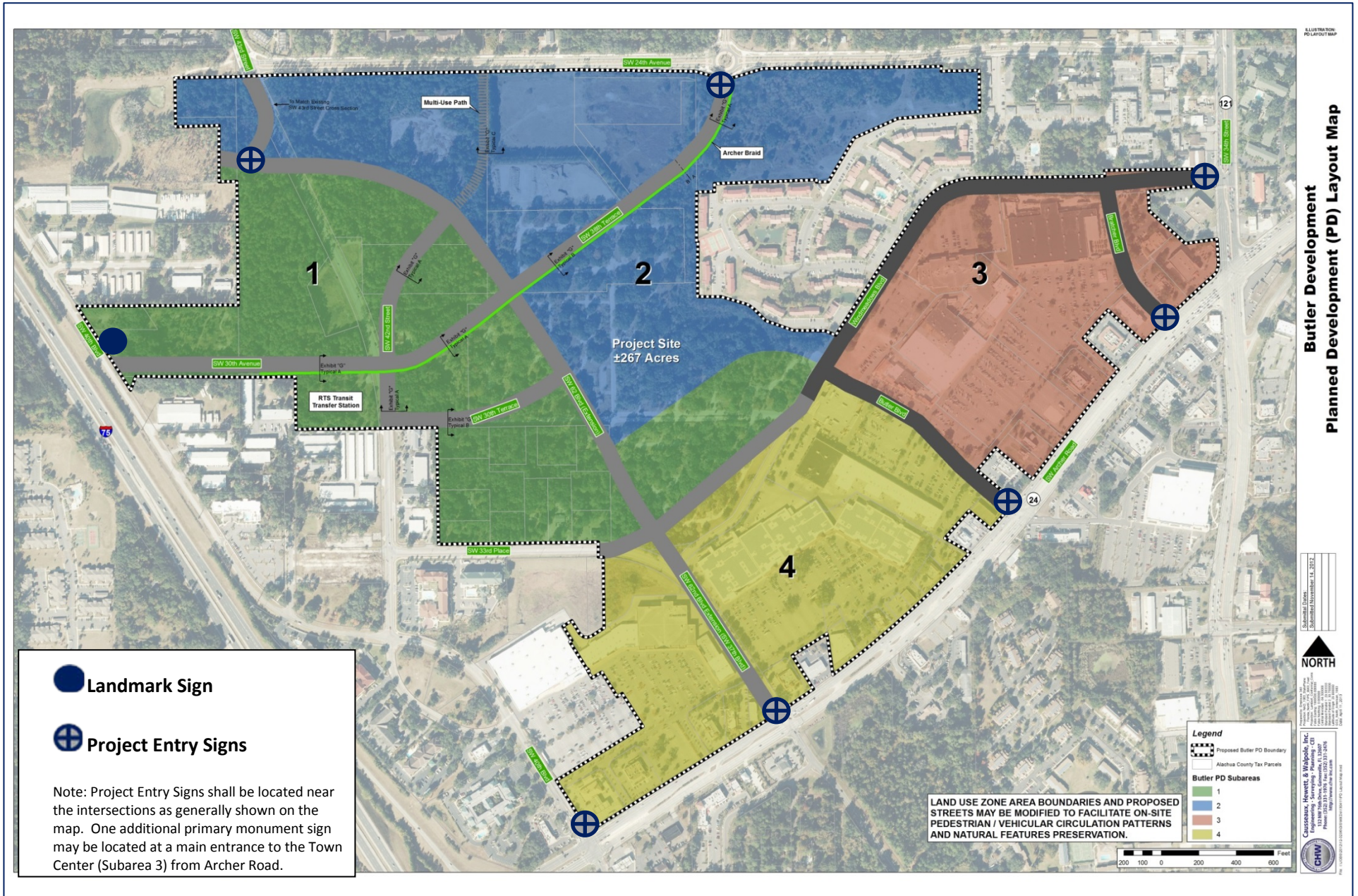

II. General Signage Standards

- A. ALL SIGNAGE WITHIN THE BUTLER DEVELOPMENT SHALL MEET THE SIGNAGE REGULATIONS SET FORTH IN THE CITY OF GAINESVILLE LAND DEVELOPMENT CODE IN EFFECT AT THE TIME OF APPLICATION FOR A SIGN PERMIT, EXCEPT AS EXPRESSLY PROVIDED BY THIS BUTLER DEVELOPMENT MASTER SIGNAGE PLAN.
- B. ALL SIGNS SHALL CONVEY THE CHARACTER, THEMES, AND ARCHITECTURAL DESIGN CONSISTENT WITH THE PLANNED DEVELOPMENT AND THE FOUR SUBAREAS.
- C. SIGNS MAY BE PLACED ON PROPERTY LINES WITHIN THE DEVELOPMENT AND NO MINIMUM SETBACKS ARE REQUIRED.
- D. WITHIN THE TOWN CENTER, PROJECT ENTRY AND DIRECTIONAL SIGNS SHALL BE DESIGNED AS ARCHITECTURAL FEATURES, AND THEY SHALL BE COMPATIBLE WITH AND COMPLEMENT THE ADJACENT BUILDINGS. THEY SHALL BE LOCATED ON STRUCTURES OR FRAMES BETWEEN BUILDINGS AT ARCADES, COLONNADES, OR SIMILAR FEATURES.
- E. WITHIN THE TOWN CENTER, ALL VEHICULAR DIRECTIONAL SIGNS SHALL BE OF A TYPE WITH DECORATIVE POST(S) AND FINIALS TO MATCH STREET LIGHTING.

III. Landmark Sign

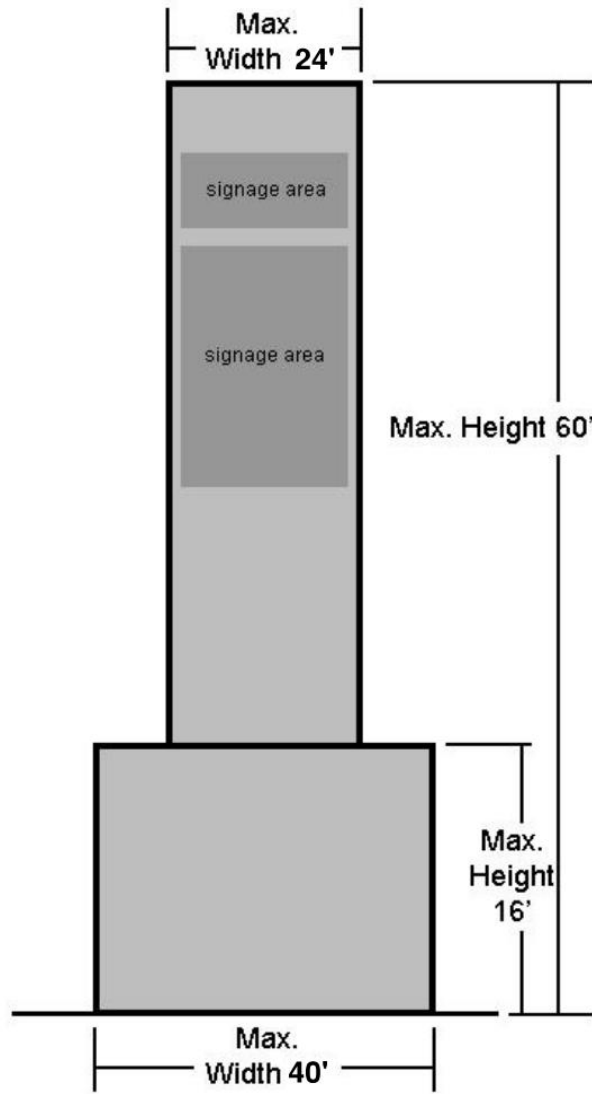

LOCATION: SUB-AREA 1 AT I-75
MAX. HEIGHT: 60'
MAX. WIDTH: 24' (40' BASE)
MAX. SIGN AREA: 845 SQ. FT.
MATERIALS: MASONRY OR STUCCO OR SIMILAR MATERIAL
LIGHTING: SIGN FACE MAY BE EXTERNALLY ILLUMINATED; OR BACKLIT LETTERING
 STRUCTURE MAY CONTAIN EXTERNAL OR INTERNAL ACCENT LIGHTING
NOTE: A SINGLE LANDMARK SIGN IS ALLOWABLE WITHIN THE BUTLER DEVELOPMENT, AS SHOWN ON THE SIGN LOCATION MAP.
INTENT: TO PROVIDE AN ICONIC, ARCHITECTURALLY SIGNIFICANT STRUCTURE THAT IDENTIFIES THE DEVELOPMENT AND TENANTS AS A DESTINATION FOR SHOPPING, DINING, AND ENTERTAINMENT. THIS STRUCTURE WILL BE CONSISTENT WITH THE OVERALL ENVIRONMENTAL GRAPHICS DESIGN PACKAGE. THE SIGNAGE AREAS ON THIS STRUCTURE ARE INTENDED TO BE SEEN FROM I-75. THEREFORE, THE SIGNAGE AREAS SHOULD BE LARGE ENOUGH THAT THEY ARE SAFELY VISIBLE AND LEGIBLE FROM I-75 AS NOT TO CAUSE DANGERS OR HAZARDS TO PASSING MOTORISTS. VISUAL EXAMPLES OF THE INTENT FOR THE LANDMARK SIGN ARE PROVIDED ON THE FOLLOWING PAGE.

III. Landmark Sign

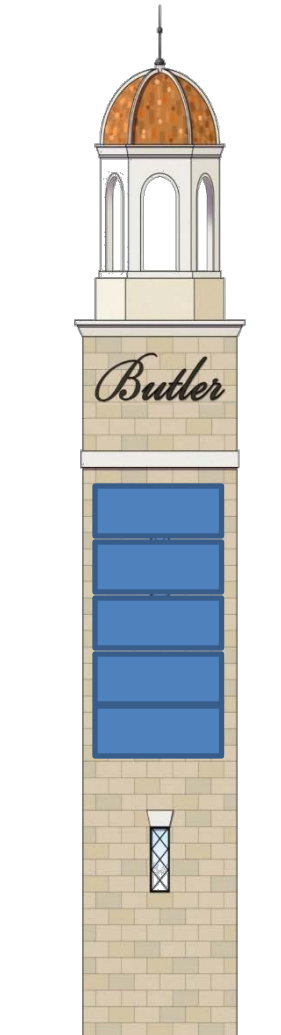

IV.A. Project Entry Sign Type 1

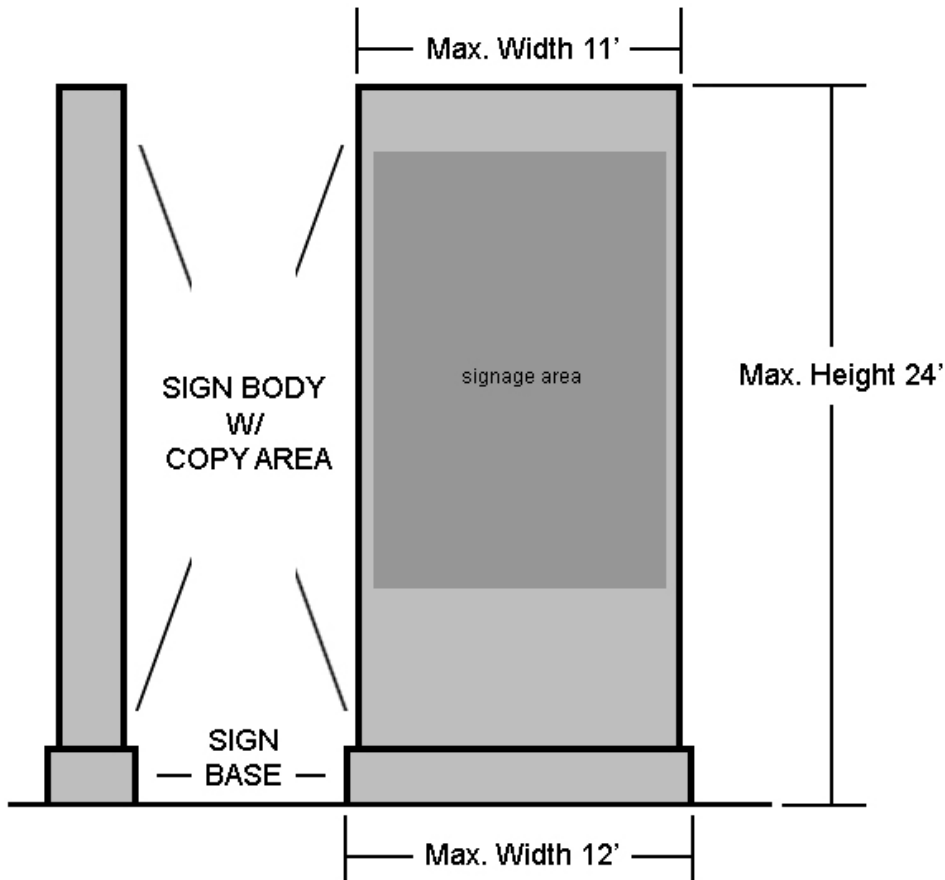

LOCATION: SHALL BE LIMITED TO ONE TYPE 1 OR TYPE 2 AT EACH OF THE FOLLOWING INTERSECTIONS/LOCATIONS:

- ARCHER ROAD AT SW 40TH BOULEVARD
- ARCHER ROAD AT SW 62ND BOULEVARD
- ARCHER ROAD AT SW 35TH BOULEVARD
- ARCHER ROAD AT BRATCHER BOULEVARD
- SW 62ND BOULEVARD AT SW 43RD STREET
- SW 38TH TERRACE AT SW 24TH AVENUE
- WINDMEADOWS BOULEVARD AT SW 34TH STREET
- MAIN ENTRANCE TO TOWN CENTER AT ARCHER ROAD (THIS LOCATION IS NOT DEPICTED ON THE SIGN LOCATION MAP AS IT HAS NOT YET BEEN DETERMINED.)

MAX. HEIGHT:	24'
MAX. WIDTH:	11' (12' BASE)
MAX. SIGN AREA:	180 SQ FT PER FACE
MATERIALS:	ALUMINUM BODY (OR SIMILAR), CONCRETE BASE
LIGHTING:	MAY BE INTERNALLY OR EXTERNALLY ILLUMINATED

IV.B. Project Entry Sign Type 2

LOCATION: SHALL BE LIMITED TO ONE TYPE 1 OR TYPE 2 AT EACH OF THE FOLLOWING INTERSECTIONS/LOCATIONS:

- ARCHER ROAD AT SW 40TH BOULEVARD
- ARCHER ROAD AT SW 62ND BOULEVARD
- ARCHER ROAD AT SW 35TH BOULEVARD
- ARCHER ROAD AT BRATCHER BOULEVARD
- SW 62ND BOULEVARD AT SW 43RD STREET
- SW 38TH TERRACE AT SW 24TH AVENUE
- WINDMEADOWS BOULEVARD AT SW 34TH STREET
- MAIN ENTRANCE TO TOWN CENTER AT ARCHER ROAD (THIS LOCATION IS NOT DEPICTED ON THE SIGN LOCATION MAP AS IT HAS NOT YET BEEN DETERMINED.)

MAX. HEIGHT: 15'
MAX. WIDTH: 24' PER SIDE
MAX. SIGN AREA: 115 SQ FT PER FACE PER SIGN
MATERIALS: ALUMINUM BODY (OR SIMILAR), CONCRETE BASE
LIGHTING: MAY BE INTERNALLY OR EXTERNALLY ILLUMINATED

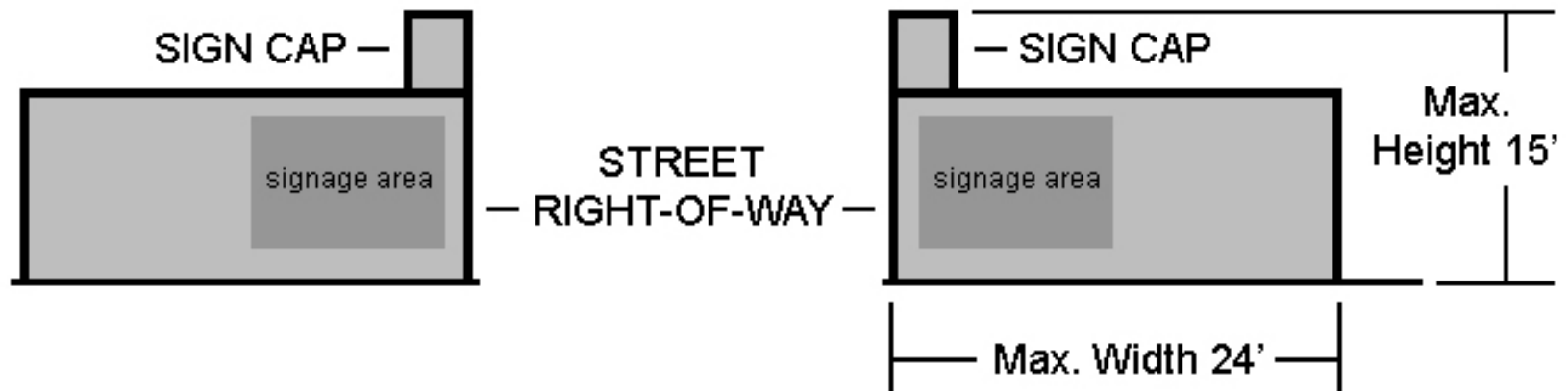

V. Monument Signs

LOCATION: MAY BE LOCATED ON A MAXIMUM OF THREE (3) SIDES OF ANY SINGLE OR MULTIPLE OCCUPANCY DEVELOPMENT THAT HAS FRONTAGE ON A PUBLIC STREET, PRIVATE STREET, OR MANEUVERING LANE.

MAX. HEIGHT:	14'
MAX. WIDTH:	15' (EXCLUDING THE BASE)
MAX. SIGN AREA:	110 SQ FT PER FACE
MATERIALS:	ALUMINUM BODY (OR SIMILAR), CONCRETE BASE
LIGHTING:	MAY BE INTERNALLY OR EXTERNALLY ILLUMINATED
LIMITATIONS:	MAY ONLY BE PLACED AT VEHICULAR ENTRANCES TO A DEVELOPMENT, AND MAY NOT BE PLACED AT LOCATIONS APPROVED FOR PROJECT ENTRY SIGNS.



VI. Outparcel Signs

OUTPARCEL SIGNS

NUMBER:	ONE (1) MONUMENT-STYLE SIGN WITH TWO SIDES PER OUTPARCEL
LOCATION:	MAY BE LOCATED ALONG ANY PUBLIC STREET, PRIVATE STREET, OR MANEUVERING LANE WHERE THE OUTPARCEL HAS FRONTAGE
MAX. HEIGHT:	8'
MAX. SIGN WIDTH:	5' (EXCLUDING THE BASE)
MAX SIGN AREA:	32 SQ FT PER SIGN FACE
MATERIALS:	ALUMINUM BODY (OR SIMILAR), CONCRETE BASE
LIGHTING:	MAY BE INTERNALLY OR EXTERNALLY ILLUMINATED

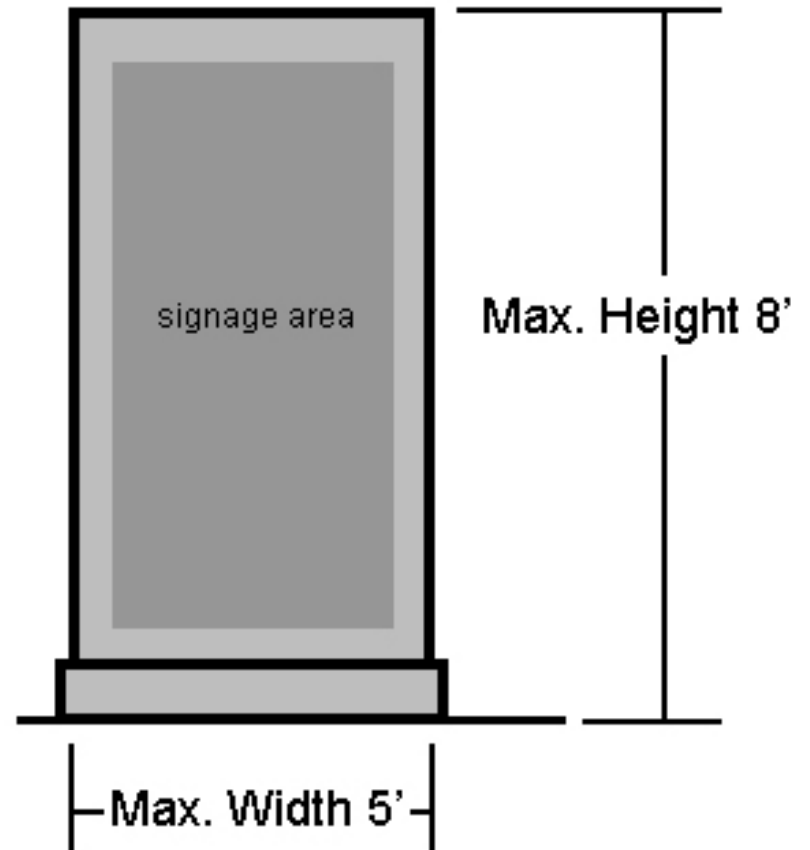

VII. Project Directional Sign

DIRECTIONAL SIGN TYPE 1

MAX. HEIGHT:	8'
MAX. SIGN WIDTH:	3'
MAX. SIGN AREA:	24 SQ FT PER SIGN FACE
MATERIALS:	ALUMINUM BODY (OR SIMILAR)
LIGHTING:	MAY BE INTERNALLY OR EXTERNALLY ILLUMINATED

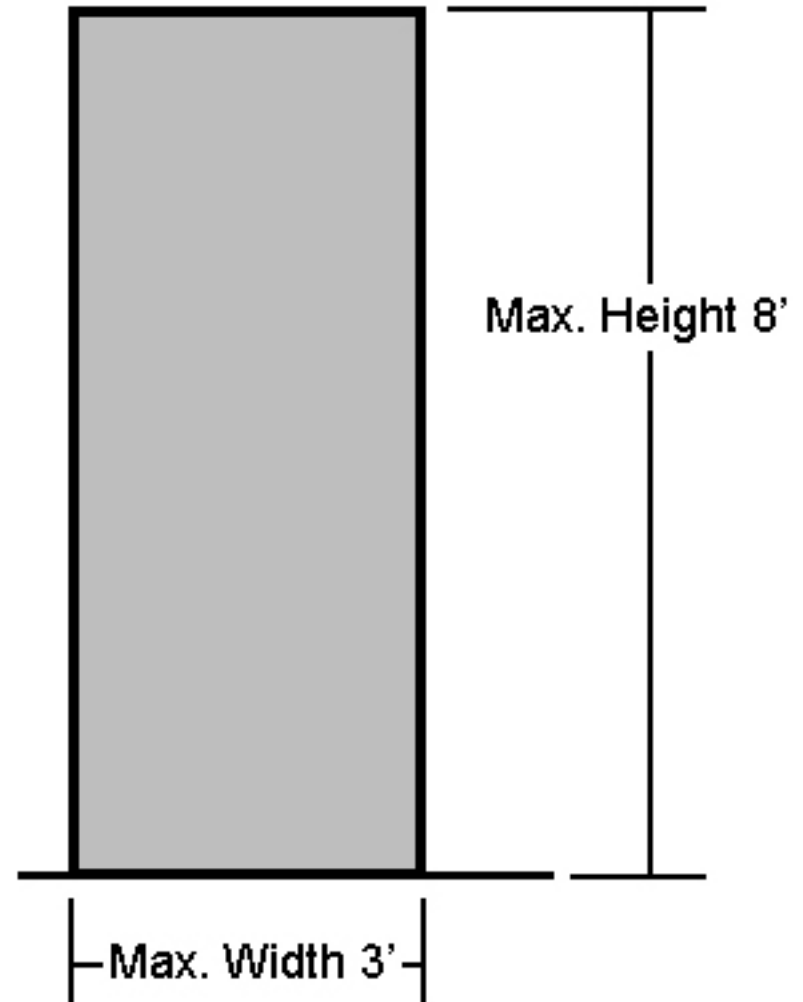

VIII. Vehicular Directional Sign

DIRECTIONAL SIGN TYPE 2

MAX. HEIGHT: 12'

MAX. SIGN AREA: 2 SQ FT PER SIGN FACE

MATERIALS: ALUMINUM BODY (OR SIMILAR)

LIGHTING: MAY CONTAIN LIGHTING ON TOP OF POLE

MINIMUM CLEARANCE: 7'

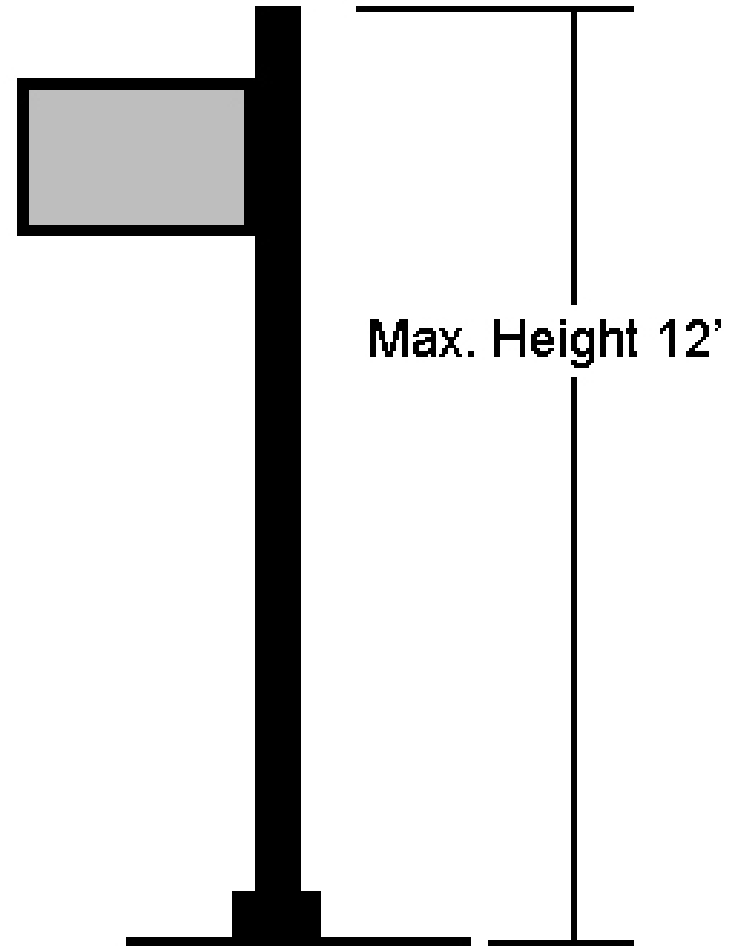

IX. Pole Banners

POLE BANNER SIGNS

MAX. HEIGHT: 12'

MAX SIGN AREA: 18 SQ FT PER SIGN FACE

MATERIALS: ALUMINUM BODY (OR SIMILAR)

LIGHTING: MAY CONTAIN LIGHTING ON TOP OF POLE

MINIMUM CLEARANCE: 7'

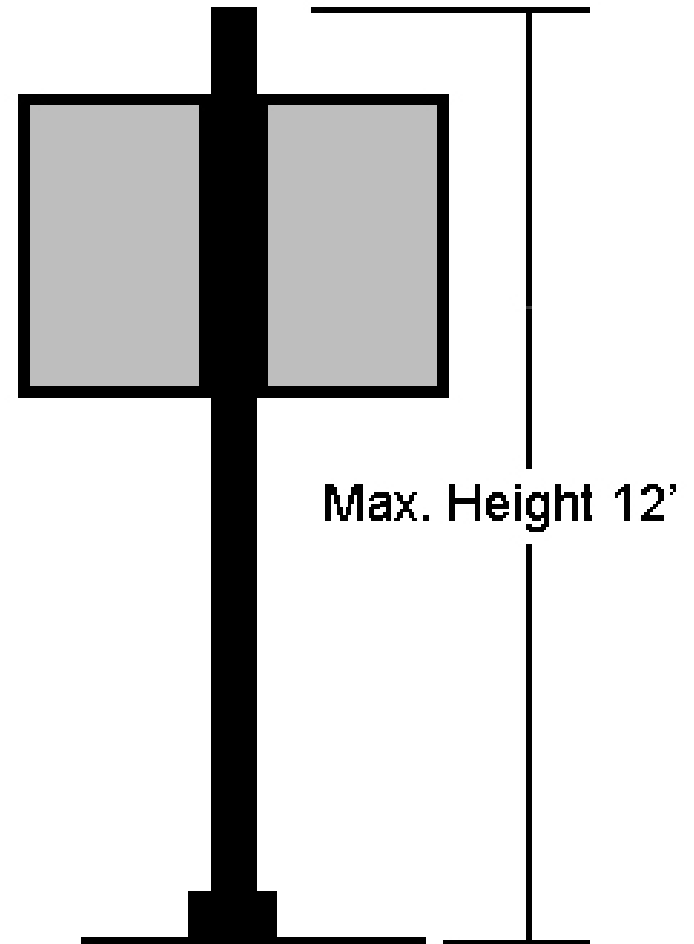

X. Wall Signs

MAXIMUM NUMBER:	EACH OCCUPANT MAY HAVE ON EACH SIDE THAT THE OCCUPANT HAS AN EXTERIOR FAÇADE VISIBLE TO PUBLIC STREETS, PRIVATE STREETS, OR MANEUVERING LANE, UP TO FOUR (4) MAX PER OCCUPANT
LOCATION:	WALL SIGNS MAY EXCEED BUILDING ROOF OR PARAPET LINES
MAX. SIGN AREA:	PRIMARY ENTRANCES/EXIT: 1.5 X FAÇADE LENGTH OF THE LEASED SPACE; HOWEVER, WALL SIGNS IN SUBAREAS 2 AND 3 MAY NOT EXCEED 200 SQUARE FEET IN AREA NON-ENTRANCE/EXIT SIDES: 1.5 X FAÇADE LENGTH WITH A MAXIMUM OF 200 SQUARE FEET PER SIGN AND AN AGGREGATE MAXIMUM OF 400 SQUARE FEET
PROJECTION:	WALL SIGNS MAY NOT PROJECT MORE THAN 24"
LIGHTING:	MAY BE INTERNALLY OR EXTERNALLY ILLUMINATED, USE OF ARCHITECTURAL LIGHTING AND CHARACTER OR PERIOD LIGHTING MAY BE ALLOWED FOR BRAND ENHANCEMENTS

NOTES:

- PRIMARY ENTRANCES CAN BE ON MORE THAN ONE (1) SIDE AND MAY BE LOCATED ON BUILDING CORNERS
- MAY BE PLACED ONLY ON THE EXTERIOR SURFACE OF THE PRINCIPAL BUILDING, OR PORTION THEREOF, WHICH IS INCLUDED AS PART OF THE OCCUPANT'S INDIVIDUALLY LEASED/OWNED PREMISES;
- SUBORDINATE 'TAG' SIGNS ARE ADDITIONALLY ALLOWED BUT SHALL COUNT TOWARDS THE OVERALL MAXIMUM SQUARE FOOTAGE.
- AN OCCUPANT WITH INDIVIDUALLY OWNED/LEASED PREMISES THAT DOES NOT INCLUDE PART OF AN EXTERIOR FACADE: ONE SIGN OF UP TO 6 SQ FT OF SIGN AREA ON ONE SIDE OF THE EXTERIOR FAÇADE OF THE PRINCIPAL BUILDING IN WHICH SUCH OCCUPANT IS LOCATED;
- FOR BUILDING WALLS THAT DO NOT HAVE AN ENTRANCE, BUILDING MOUNTED SIGNS MAY BE APPROVED ONLY WHEN THE WALL MEETS THE FAÇADE ARTICULATION STANDARDS PROVIDED FOR SUB-AREA 2 IN THE BUTLER DEVELOPMENT PD.

INTENT: THE WALL SIGNS ARE INTENDED TO PROVIDE DIRECTION AND WAY FINDING THROUGHOUT THE BUTLER DEVELOPMENT. WALL SIGNAGE IS NECESSARY ON ALL SIDES OF A BUILDING TO COMMUNICATE THE LOCATION OF DESTINATIONS AND MAKE THEM EASILY ACCESSIBLE TO VISITORS. THIS PRACTICE IS COMMONLY USED THROUGHOUT FLORIDA AND THE UNITED STATES TO SIMPLIFY NAVIGATION WITHIN REGIONAL SHOPPING, DINING, AND ENTERTAINMENT DESTINATIONS. THE WALL SIGNAGE SHOULD BE SIZED SO THAT IT IS VISIBLE FROM MOST POINTS OF THE DEVELOPMENT TO SERVE AS A DIRECTIONAL AND WAY FINDING AID. EXAMPLES OF WALL SIGNAGE FOR THIS USE ARE PROVIDED ON THE FOLLOWING PAGE.

X. Wall Signs



XI. Awning, Under-Canopy/Projecting, Blade, and Marquee Signs

AWNING SIGNS

NUMBER AND LOCATION:	ONE (1) PER OCCUPANT FOR EACH SIDE THAT OCCUPANT HAS AN EXTERIOR FAÇADE, UP TO THREE (3) SIDES MAX, THAT FACES A PUBLIC STREET, PRIVATE STREET, OR MANEUVERING LANE. MULTI-TENANT BUILDINGS SHALL BE DEEMED AS ONE SINGLE ENCLOSED BUILDING SO THAT WALL SIGNAGE IS ALLOWED ON EACH SIDE FACING A PUBLIC STREET, PRIVATE STREET, OR MANEUVERING LANE, ON UP TO THREE (3) SIDES.
MIN. PLACEMENT HEIGHT:	8' ABOVE GROUND LEVEL AS MEASURED BY THE AVERAGE GRADE DIRECTLY BELOW THE SIGN
MAX. PLACEMENT HEIGHT:	ROOFLINE, TOP OF PARAPET, OR 18 FEET, WHICHEVER IS LESS
MAX. SIGN AREA:	10 SQUARE FEET MAX WITH 16 INCHES MAX LETTER HEIGHT. WITHIN TOWN CENTER: 8 SQUARE FEET MAX WITH 12 INCHES MAX LETTER HEIGHT
MAX. WALL PROJECTION:	PROPERTY LINE

UNDER-CANOPY OR PROJECTING SIGNS

NUMBER AND LOCATION:	ONE (1) PER OCCUPANT FOR EACH SIDE THAT OCCUPANT HAS AN EXTERIOR FAÇADE, UP TO THREE (3) SIDES MAX, THAT FACES A PUBLIC STREET, PRIVATE STREET, OR MANEUVERING LANE. MULTI-TENANT BUILDINGS SHALL BE DEEMED AS ONE SINGLE ENCLOSED BUILDING SO THAT WALL SIGNAGE IS ALLOWED ON EACH SIDE FACING A PUBLIC STREET, PRIVATE STREET, OR MANEUVERING LANE, ON UP TO THREE (3) SIDES.
MIN. PLACEMENT HEIGHT:	9' ABOVE GROUND LEVEL AS MEASURED BY THE AVERAGE GRADE DIRECTLY BELOW THE SIGN
MAX. PLACEMENT HEIGHT:	ROOFLINE OR TOP OF PARAPET
MAX. SIGN AREA:	15 SQUARE FEET MAX
MAX. WALL PROJECTION:	4' FROM BUILDING FACE

BLADE SIGNS

LOCATION:	ONE (1) MAY BE PLACED AT A BUILDING ENTRANCE OF A THEATER OR HOTEL
MIN. PLACEMENT HEIGHT:	9' ABOVE GROUND LEVEL AS MEASURED BY THE AVERAGE GRADE DIRECTLY BELOW THE SIGN
MAX. PLACEMENT HEIGHT:	4' ABOVE TOP OF PARAPET
MAX. SIGN AREA:	NONE, EXCEPT THAT SIGNAGE MAY NOT EXCEED PERMITTED WALL SIGNAGE MAXIMUMS
MAX. WALL PROJECTION:	PROPERTY LINE

MARQUEE SIGNS

NOTE:	THREE (3) BUILDING-MOUNTED CABINETS WITH A MAXIMUM OF FIFTY (50) SQUARE FEET EACH ARE ALLOWED.
-------	------------------------------------------------------------------------------------------------

XII. Pedestrian Signs

PEDESTRIAN SIGNS IN SUBAREAS 2 AND 3. THE FOLLOWING PEDESTRIAN SIGNS ARE PERMITTED WITHIN SUBAREAS 2 AND 3.

- A. SIGNAGE DISPLAYED ON KIOSKS, BOOTHS, OR STANDING WALLS WITH UP TO FOUR (4) SIGN FACES EACH AT A MAXIMUM OF TWENTY (20) SQUARE FEET PER SIGN FACE. SIGNAGE ON KIOSK BOOTHS MAY BE PROVIDED IN A DIGITAL OR ELECTRONIC FORMAT PROVIDED THAT THE DIGITAL OR ELECTRONIC SIGNS ARE NOT DISTRACTING TO MOTORIST ON PUBLIC OR PRIVATE STREETS OR MANEUVERING LANES.
- B. DIRECTIONAL SIDEWALK SIGNAGE SHALL BE PERMITTED WITH UP TO A MAXIMUM OF TWENTY (20) SQUARE FEET PER SIGN FACE.
- C. CONCIERGE BOOTHS MAY HAVE A MAXIMUM OF TWENTY (20) SQUARE FEET PER BOOTH.
- D. DIGITAL / ELECTRONIC FORMAT EXAMPLES:

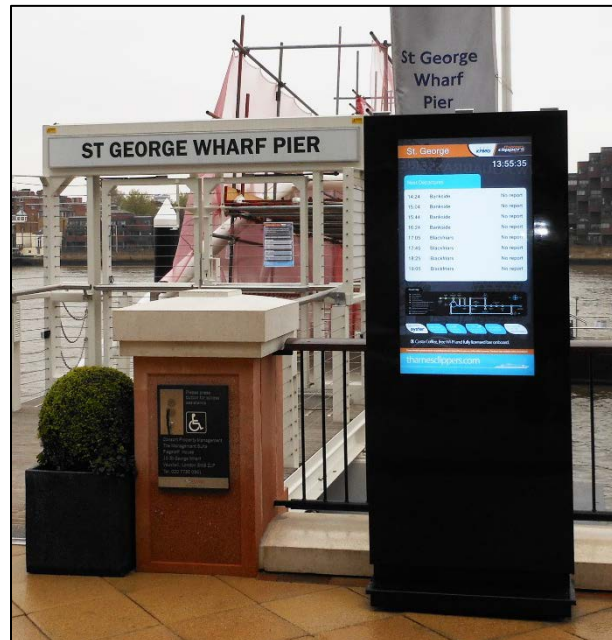

XIII. Temporary Signs

TEMPORARY SIGNS. TEMPORARY SIGNS MAY BE PERMITTED ON PARCELS WITHIN THE DEVELOPMENT.

- A. BANNER SIGNS ARE PERMITTED AT THE MAJOR ENTRANCES TO THE DEVELOPMENT AND ON OUTPARCELS. THESE TEMPORARY BANNER SIGNS WILL BE PERMITTED NOT TO EXCEED FIFTY (50) SQUARE FEET IN AREA, AND MAY BE DISPLAYED FOR A MAXIMUM OF FOURTEEN (14) CONSECUTIVE CALENDAR DAYS, EXCEPT THAT SUCH BANNERS MAY BE DISPLAYED FOR FORTY-FIVE (45) CONSECUTIVE CALENDAR DAYS DURING THE MONTHS OF NOVEMBER AND DECEMBER. THESE SIGNS SHALL NOT COUNT TOWARD THE OVERALL MAXIMUM SIGN AREAS ALLOWABLE FOR MONUMENT OR BUILDING SIGNS.
- B. POLE BANNERS MAY BE PLACED ON THE LIGHT POLES ALONG STREETS WITHIN THE DEVELOPMENT, AND SHALL NOT REQUIRE INDIVIDUAL SIGN PERMITS. DESIGN OF THESE SIGNS SHALL BE CONSISTENT WITH THE HEIGHT AND OTHER STANDARDS DEFINED IN THIS BUTLER DEVELOPMENT MASTER SIGNAGE PLAN.
- C. SIGNS IDENTIFYING THE LOCATION OF CONSTRUCTION ACCESS ROADS MAY BE PLACED ALONG STATE ROAD 24 (ARCHER ROAD), STATE ROAD 121 (SW 34TH STREET), AND SW 24TH AVENUE IN ORDER TO LIMIT THE NUMBER OF CONSTRUCTION ACCESS POINTS. THESE SHALL NOT EXCEED 64 SQUARE FEET EACH.
- D. EACH DEVELOPMENT PARCEL WITHIN THE LARGER DEVELOPMENT SITE MAY HAVE ITS OWN TEMPORARY SIGN, NOT TO EXCEED 32 SQUARE FEET EACH. ALL TEMPORARY SIGNS PLACED IN CONJUNCTION WITH A DEVELOPMENT SITE MAY BE ERECTED AT THE TIME OF FINAL DEVELOPMENT PLAN APPROVAL, AND MUST BE REMOVED NOT LATER THAN 45 DAYS FROM ISSUANCE OF A CERTIFICATE OF OCCUPANCY FOR THE PARTICULAR DEVELOPMENT.
- E. TEMPORARY WALL SIGNS, SUCH AS BANNERS ANNOUNCING COMING STORES OR GRAND OPENINGS, SHALL BE ALLOWED DURING CONSTRUCTION AND INITIAL OPENING, AND SHALL BE REMOVED NOT LATER THAN 45 DAYS FOLLOWING ISSUANCE OF A CERTIFICATE OF OCCUPANCY FOR THE PARTICULAR TENANT, BUSINESS, OR PROJECT.

XIV. Archer Road Signage

ARCHER ROAD SIGNAGE. ALONG ARCHER ROAD, NO NEW OUTPARCEL SIGN OR PROJECT ENTRY SIGN SHALL BE PERMITTED UNLESS THE DEVELOPER IDENTIFIES IN WRITING ONE (1) OR MORE EXISTING FREESTANDING SIGN(S) THAT WILL BE REMOVED UPON CONSTRUCTION OF THE NEW SIGN. IF AT THE TIME OF APPLICATION FOR A SIGN PERMIT THE DEVELOPER PROVIDES DOCUMENTATION TO THE CITY MANAGER OR DESIGNEE DEMONSTRATING THAT IT IS UNABLE TO REMOVE ANY EXISTING FREESTANDING SIGN(S) ALONG ARCHER ROAD WITHOUT VIOLATING AN APPLICABLE LEASE AGREEMENT(S) THAT WAS IN EFFECT PRIOR TO THE EFFECTIVE DATE OF THIS ORDINANCE, THE DEVELOPER SHALL IDENTIFY IN WRITING ONE (1) OR MORE EXISTING FREESTANDING SIGN(S) THAT WILL BE REMOVED NO LATER THAN A SPECIFIC DATE(S) AFTER THE EXPIRATION OF THE APPLICABLE LEASE AGREEMENT(S). THIS PROVISION WILL REMAIN EFFECTIVE UNTIL SUCH TIME AS ALL FREESTANDING SIGNS LAWFULLY PERMITTED PRIOR TO THE ADOPTION OF THE BUTLER DEVELOPMENT PD ORDINANCE NO. 121108 HAVE BEEN REMOVED.