

ADDENDUM NO. 4

Date: February 1, 2021

Bid Date: February 9, 2021, at 3:00 P.M. (Local Time)

Bid Name Clarence R. Kelly Community Center and Park

Bid No.: WSPP-210016-DM

NOTE: This Addendum has been issued only to the holders of record of the specifications and to the attendees of the mandatory pre-bid conference held on January 14, 2021.

The original Specifications remain in full force and effect except as revised by the following changes which shall take precedence over anything to the contrary:

1. Any questions shall be submitted in writing to the City of Gainesville Purchasing Division by 5:00 p.m.(local time), January 26, 2021 (Revised Question Deadline).

Questions may be submitted as follows:

Email: mcphalldt@cityofgainesville.org

The following are answers/clarifications to questions received at the mandatory pre-bid conference:

2. Question: Confirm that all existing playground equipment, fencing, etc. that is scheduled to be removed becomes the property of the contractor.
Answer: All playground equipment, fencing, etc. remaining on the site at the start of demolition shall become the property of the contractor.
3. Question: Verify that the City will provide all material testing, including earthwork, paving, concrete, masonry, steel, etc. If the contractor is to perform testing, provide a specification and frequency for each.
Answer: Contractor is required to provide all material testing required to comply with applicable codes and regulations as well as where indicated in the drawings and specifications.
4. Question: Will the Bid Form be revised to reflect a separate line item for the \$60,000 allowance for the installation of the playground and adult fitness equipment added per Addendum 1, Item #32?
Answer: See attached .
5. Question: Verify that the “engineered wood fiber (EWF)” noted on Sheet L1 is to be furnished and installed by others and not included in the bid price.

Answer: All Engineered Wood Fiber shall be furnished and installed by the contractor and should be included in their bid price.

6. Question: Provide a copy of the list maintained by the City of debarred or suspended contractors and subcontractors per Article 30 in the Instructions to Bidders, Paragraph 30.4.

Answer: The City does not maintain a comprehensive debarred or suspended contractors list.

7. Question: Confirm that this is not a “LEED” or “Green” project requiring additional submittal/product data information, since several sections of the Specifications refer to sustainable design and “LEED” documentation.

Answer: Confirmed. This is not a LEED or Green project.

8. Question: Verify that the contractor is to include state sales tax in the bid price for all materials, since Article 22 in the Instructions to Bidders implies that the City will provide the contractor with a tax-exempt certificate as needed for each purchase.

Answer: The contractor is responsible for paying all applicable sales taxes on materials they furnish.

9. Question: Confirm that the City will not accept any substitutions for the contractor’s convenience after the bid date, since the Plans and Specifications list only one acceptable manufacturer (single source) for a number of products. Examples include light fixtures, plumbing fixtures, HVAC equipment, kitchen equipment, roller shades, ceramic/porcelain tile, resinous epoxy flooring, LVT flooring, acoustical ceilings, insulated glass, coiling counter door, garden fence, garden shed, site furnishings, etc.

Answer: The City of Gainesville endeavors to solicit maximum participation by our business community in procurements and to minimize the cost of projects for our taxpayers. As such, “or-equal” substitution requests are encouraged to avoid sole-sourcing products whenever possible. The Invitation for Bid instructs contractors to submit those requests in advance of the bid due date so that a determination can be made about the product’s suitability for the project while pricing is still being compiled. After award, the successful contractor is not prohibited from making “or-equal” substitution requests, but no assumption should be made regarding the acceptability of that product. These requests will be reviewed by the Project Manager and the determination as to whether a product is an acceptable equivalent is at the sole discretion of the City of Gainesville. The contractor assumes all risk associated with the request and understands that the contractually specified product may be required.

10. Question: Provide outside dimensions (size) for the concrete basketball court, including measurements for the striping layout.

Answer: 88’-4” x 58’-4” striping to follow standard striping shown below:

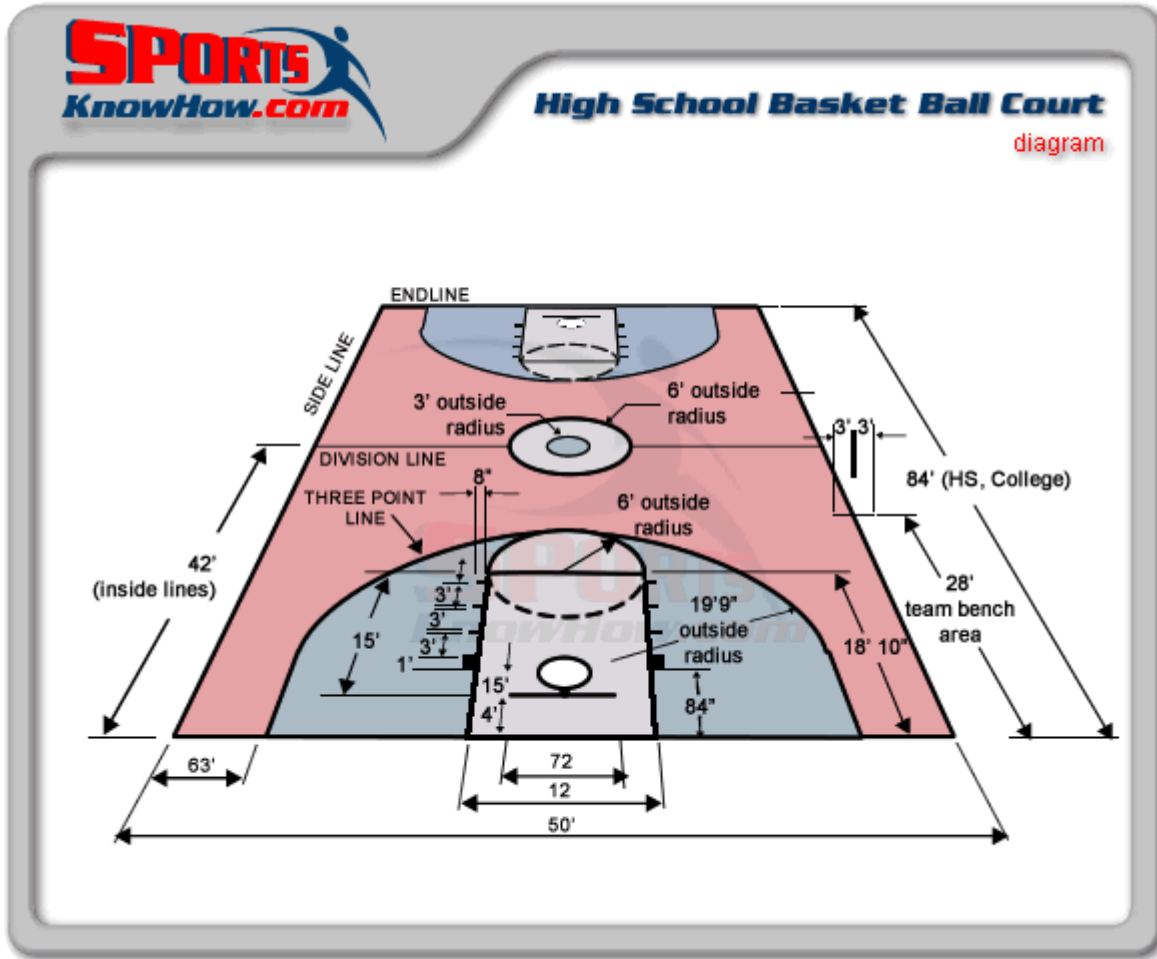

11. Question: Provide details and quantity for the 42" painted concrete bollards noted as Item A180 on Sheet A-001.

Answer: Quantity as per plan.

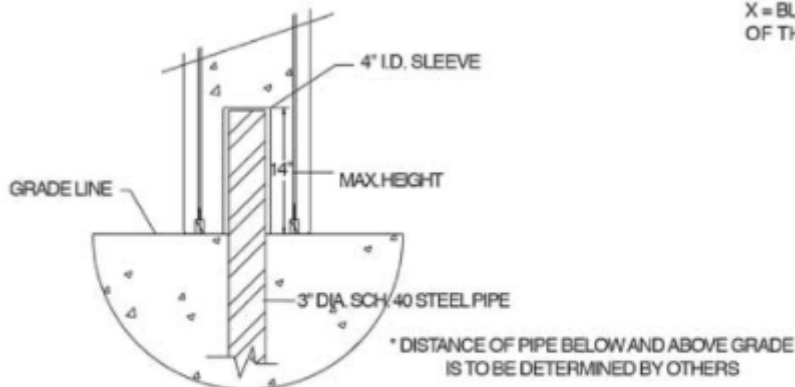

NOTE: THIS TYPE ANCHORING IS ALSO USED AS A BARRICADE BOLLARD HELD IN PLACE BY STEEL PIPE
 STEEL PIPE MUST BE ANCHORED IN CONCRETE FOOTING
 TYP. 12' DIA. CONCRETE BOLLARD SAME ANCHORING SYSTEM USED ON 14' AND 18' DIA. OR SQ. BOLLARDS

12. Question: Provide a specification and layout for the lighting along the sidewalk as noted per Item A07 on Sheet A-001, since none are shown on the electrical drawings.
Answer: Lighting along sidewalk removed from contract.
13. Question: Provide a specification for the exterior building backlit signage per Note A21 on Sheet A-300.
Answer: Lighting by signage subcontractor. Lighting to be Hanley LED – Pergrine 1036-HLED-P1036W or similar. Subcontractor to include lighting modules and power supply in contract.
14. Question: Provide a specification for the exterior building 8” aluminum signage per Note A133 on Sheet A-301.
Answer: ¼” cut aluminum on standoffs. See Addendum #2.
15. Question: Provide a specification for the painting of the exterior fiber cement siding.
Answer: Fiber-Cement Siding and Soffits, Satin Finish: Acrylic Latex.
Primer: Not required. Material is factory primed.
1st Finish Coat: S-W Duration Exterior Latex Satin, K33 Series (2.2-2.6 mils dry).
2nd Finish Coat: S-W Duration Exterior Latex Stain, K33 Series (2.2-2.6 mils dry).
16. Question: Provide a specification for the interior painting of the exposed overhead steel joists, beams, metal roof deck, conduits, pipes, etc.
Answer: Follow specifications for painting interior Ferrous Metal and Non-Ferrous Metal. SW Pro-Industrial Waterborne Acrylic Dryfall may be used in lieu of Pro Industrial Waterborne Acrylic Semi-gloss for all overhead painting on ferrous and non-ferrous metals.
17. Question: Confirm that the wood doors are to be factory finished or provide a specification for field applied stain.
Answer: See Addendum #2
18. Question: Provide a finish for the coiling counter door, since the specification includes a number of options to be selected from.
Answer: Clear anodized finish.
19. Question: Verify that the bid price is to include 12 months of full maintenance with 24/7 service availability for the coiling counter door as outlined by the specifications.
Answer: Not required.
20. Question: Verify that the coiling counter door is manually operated, instead of electric motor operated. If motor operated, provide electrical design and requirements.
Answer: The coiling counter door is manually operated.
21. Question: Confirm that all roller shades are manually operated, instead of electric motor operated. If motor operated, provide electrical design and requirements.
Answer: Convert all seven motorized roller shades shown on Sheet A-201 in the Medium & Large Activity Rooms to manual operation.

22. Question: Provide details, including finishes and options for the garden shed noted on Sheet A-002.
Answer: Lap siding, left justified 36" standard door, no windows, no interior finish package. Door, eave and siding color to be selected from base color options.
23. Question: Verify that the bid price is to include the extra added cost for the following items:
- Administrated project website with multiple licenses and hours of training per Section 013100.
 - Schedules prepared by outside consultants, including cost/resource loading, multiple reports and required attendance at each progress meeting per Section 013200.
 - Extensive photographic documentation performed by a professional photographer per Section 013233.
 - Professional videographer to document all demonstrations and training sessions per Section 017900.
 - On-site Waste Management Coordinator documenting the recycling efforts and completing the CWM forms per Section 017419.
 - Common use field office of sufficient size to accommodate meetings of ten people with a private toilet and a desktop computer for use by the architect and owner per Section 015000.
- Answer: Omit all of these requirements.
24. Question: Confirm that the entire site is to be enclosed with a 6' temporary construction fence without a top rail or vision/windscreen.
Answer: Security of the project site is the responsibility of the contractor.
25. Question: Should the structure include "In-Building Public Safety Radio Enhancement System" as implied under the Site Information Note on the Cover Page of the Plans? If so, provide specifications and design.
Answer: System shall be minimum to comply with all applicable codes and regulations as indicated on cover sheet.
26. Question: Confirm that the power poles and overhead wire along the west side property line as shown on Sheet C2 will be removed/relocated by others.
Answer: The successful contractor will be responsible for coordinating with GRU for the removal of the two utility poles and overhead power lines along the west side of the property. Any costs associated with that work are the responsibility of the contractor.
27. Question: Provide a specification and design for the 6 - 4' X 8' raised garden beds as noted on Sheet A-002.

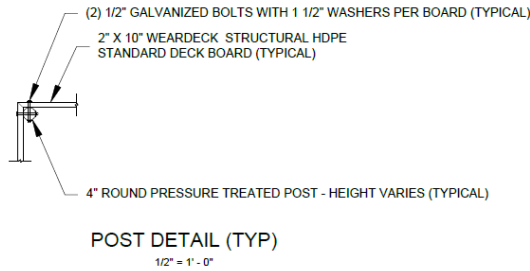
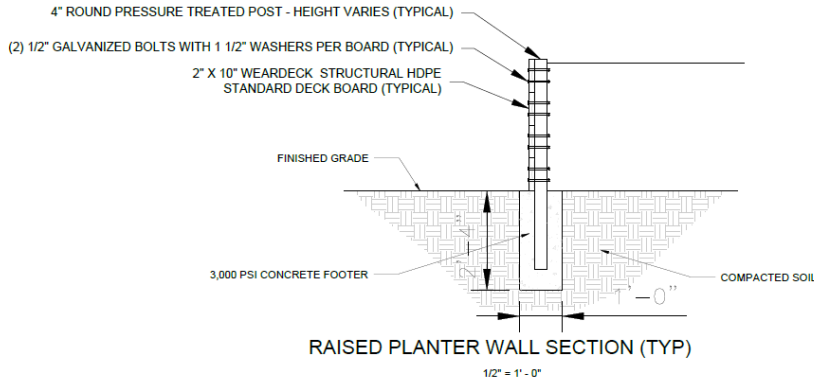

Answer:

The bottom of the planter will be 2"x 10" WearDeck structural HDPE standard deck boards with 1/4" gaps between the boards for drainage. They shall rest on a bottom rail that is attached to the lowest edge of the sides. The bottom shall then be covered with weed blocking fabric that wraps 6" up each side and 3" of pea gravel for drainage. The remainder is filled with potting soil to within 2" of the top of the planter bed. There should be 12" of potting soil in each planter.

28. Question: Confirm that "AWI Certification" is required for the cabinets and countertops per Sections 064116 and 123623.13, since this will limit subcontractor participation.

Answer: Confirmed. Subcontractors are encouraged to submit "or-equal" substitution requests as described earlier in this Addendum.

29. Question: What type of glass/glazing is to be installed in the storefronts since Section 088000 includes both laminated and insulated glass specifications?

Answer: Exterior glazing shall be an insulating-laminated glass meeting all requirements listed in 2.12 of specification 088000. Basis of design exterior glazing Viracon VNE24-53.

30. Question: Verify that "Water Spray Testing" of the installed storefronts will be required per Section 084113. Also confirm that "each area" as noted in the specifications refers to each separate window/storefront since this will add cost and time to the project.

Answer: Yes, this will be required at each storefront.

31. Question: Should the bid price include in-place relative humidity testing of the new concrete slab on grade prior to the installation of any flooring material? Also confirm that the bid price should include a moisture mitigation coating product over the new slab on grade where the relative humidity exceeds the flooring manufacturer's requirements.

Answer: Yes both are required per specifications.

32. Question: Is a roof hatch and/or roof ladder required as implied per Section 077200 since they are not shown on the plans?
Answer: See Addendum #2.
33. Question: Should roof walkway pads be installed as implied per Section 075423 since none are indicated on the plans?
Answer: Walkway pads shall be provided around all sides of serviceable rooftop equipment.
34. Question: Confirm that the roofing is to be tested and inspected by an independent agency other than the roof manufacturer as implied per Section 075423.
Answer: This is not required.
35. Question: Confirm that a moisture survey of the roof will be required per Section 075423, since this is unusual for a new roof.
Answer: This is not required.
36. Question: Verify that the bid price is to include the extra added cost for a one-year maintenance agreement for the irrigation system as noted on Sheet IR4, Paragraph 3.17(A).
Answer: This requirement is satisfied by the contractor's standard 1-year warranty.
37. Question: Verify that the City will perform all tree limb trimming and pruning that may be required of the existing trees that are to remain.
Answer: Tree limb trimming and pruning is the contractor's responsibility and should be done under the supervision or at the direction of a certified arborist. City of Gainesville urban forestry staff is available to provide guidance to the contractor.
38. Question: Where is "spray polyurethane foam insulation" installed per Section 072100 since it is not shown on the plans?
Answer: Spray polyurethane foam insulation is to be used where batt insulation is called for and can not be installed due to obstructions.
39. Question: Where is "self-adhering non-bituminous sheet air barriers" installed per Section 072715 since it is not shown on the plans?
Answer: This is to be used on sheathing at all stucco soffits.
40. Question: Provide a specification for the translucent vinyl window film as noted per Item A19 on Sheet A-300.
Answer: Basis of design: 8170-P40 - 3M™ Scotchcal™ Perforated Window Graphic Film 8170-P40.
41. Question: Provide a specification and details for the 6" curb separating the garden area from the lawn area per 8/A-002.
Answer: This is to be a standard concrete mow strip.

Shrub Bed with Mowing Strip and Weed Control Fabric

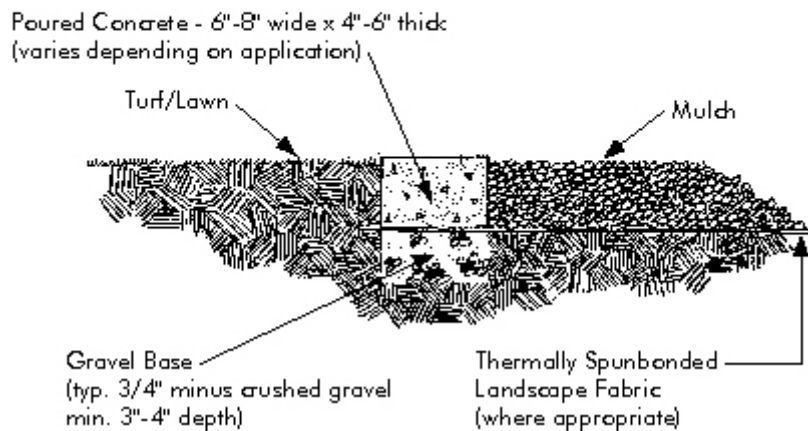

42. Question: Provide a specification and details for the 3 – 64" TV mounting brackets since they are not included in the Schedule on Sheet A-500.
Answer: This should be a standard TV mounting bracket.
43. Question: Provide a specification for the electric motor/operator for the projector screen since it is not included on Sheet A-500.
Answer: Da-Lite Advantage Electrol automatic projection screen 137" diagonal 16:10 format.
44. Question: Is the dumpster enclosure to be painted exposed CMU or painted stucco?
Answer: Painted stucco on exterior and top cap and painted block on the interior.
45. Question: Provide a copy of all permits and approvals that alter, modify or change any details or work as shown on the plans.
Answer: All permit comments have been included into the plans and specifications with the possible exception of the Grease Trap Interceptor permit which is attached to this Addendum.
46. Question: Where on the plans is the shell aggregate path per 4/L3 to be installed?
Answer: This is located at the NW corner of the lot at the radiused planting areas. See sheet L1.
47. Question: Should the slab at the restroom areas be recessed to accommodate a mud-set tile floor since it is not shown Sheets A-110 and S202?
Answer: The slabs in all restrooms should be sloped to drain as indicated on A-110. Full recessed slab in these spaces is not required.
48. Question: Provide specifications and details for mounting/suspending the 4' X 6' clouds shown on Sheet A-201. Also provide a specification for the clouds including thickness, texture, color and trim
Answer: Specification on A-201 – Armstrong soundscape ceiling cloud 4'x 6'. Thickness and texture and Armstrong standard. No trim. Color will be selected from standard color options. Mounting/ installation is standard from Armstrong.
49. Question: Provide details and design for the pathway lighting noted on 1/A-002 since it is not shown or

specified on the electrical plans.

Answer: Not in contract.

50. Question: Provide coordinated details for the 1" water line to the fountain noted on Sheet C10 since it is not shown on Sheet P-301. Also provide a specification with mounting details and drain for the fountain.

Answer: Make connection to ¾" CW at EWC-2 exterior wall mount fountain. Contractor to follow manufacturer's installation details.

51. Question: Will there be any need for Aerial Drone services for this contract? Or 360VR tour once completed?

Answer: No.

52. Question: Provide coordinated roof drain details since Sheet C7 shows 3 connections, whereas Sheet P-201 shows only 2 outlets.

Answer: Provide 2 connections as shown on P-201. East connection on C7 can be omitted.

53. Question: Specification 083313 Coiling Counter Doors

Door not listed on door schedule. **What are quantity and sizes?**

Multiple door operation referenced **what is required? push/pull, chain, crank, motor?**

Multiple finishes are specified **what is required?**

Answer: Door is in equipment schedule sheet A-500 and detail 1/A-500. Quantity 1. Crank operation. Clear anodized finish.

54. Question: Specification 102239 Folding Panel Partition

Section 2.2 E STC **not less than 51 differs from Detail 1/A-401 43 STC, please advise.**

Section 2.2 F NRC of **.5 is not possible. Please advise**

Section 2.6 A Pass Doors - **is this required?**

Answer: Follow specification for STC. NRC requirement can be omitted. Pass door is required.

55. Question: Will the window shades have fascia or be in a recessed pocket?

Answer: Both conditions exist in project. Follow A-201 detail callouts referencing shade details on A-621.

56. Question: Will the playground equipment require 3rd party testing by a CPSI inspector?

Answer: No.

57. Question: Will the playground surfacing require impact testing by a CPSI inspector?

Answer: No.

58. Question: Plans and specs call for an impact rated storefront system. Site location is not in a geographic area that requires such a system. A substantial amount of money could be saved if a standard framing and glazing system was utilized. Please advise.

Answer: See Addendum #2.

59. Question: In regards to question 13 in addendum#1. If the City of Gainesville is purchasing the Playground

and Fitness equipment directly, does the bidding general contractor still need to carry the allowance of \$225,000.00 in our complete bid to the city as was communicated in the original ITB?

Answer: Yes.

60. Question: Sheet C8 has a detail for stabilized grass parking, but it is not clear where it is located on the plans. Please clarify if there will be stabilized grass parking on this project.

Answer: This was removed from the project. There is no stabilized grass parking in the contract.

61. Question: The water service on Utility Plan C10 is difficult to read and has conflicting notes. Can you please provide a larger detail and clarification for the water service per the utility plan?

Answer: The water connection is very simple; just a tap and short run of pipe. As to the conflicting notes, those were the ones given to us directly from GRU. This is a standard GRU connection that is done by GRU.

62. Question: Since the storm water pond will be a wet pond, will a chain-link fence be required to surround the pond once the park is open?

Answer: When the banks of a pond (wet or dry) are 4:1 or flatter, fencing is not required per water management district rules. Our pond banks are 4:1, so no fence is needed. In addition, a shallow, flat littoral zone is provided around the pond for additional safety.

63. Question: C-6 shows the dimensions of the basketball court as 88.33' x 58.33'. A-002 shows the dimensions as 84' x 54'. Which is correct?

Answer: Architectural is dimensioning the striping. Follow C-6 for the overall slab dimension.

64. Question: L2 landscape note 23 references shredded cedar mulch for organic mulch. L1 landscape plan calls for organic mulch or EWF at 3" depth in the proposed education area and to verify with owner final material specification.

Requesting confirmation of:

Organic mulch spec (cedar confirmed?)

Locations of organic mulch vs EWF

Answer: Provide EWF and organic mulch (cedar mulch) where indicated on the plan. Provide EWF at proposed educational area in question.

65. Question: We would like to submit the following Mechanical/HVAC questions:

1. Please advise approved manufacturers for the VRF/mini split units (i.e. LG, Daikin, or Samsung)

2. Please advise approved manufacturers for the direct expansion split systems (i.e. Carrier or York)

Answer: 1. Mitsubishi, Daikin, and Samsung are approved manufacturers.

2. Trane, York, and Daikin are approved manufacturers.

66. Bid Opening Information February 9, 2021 at 3:00p.m. via Zoom (Attendance is not mandatory).

Join Zoom Meeting

<https://us02web.zoom.us/j/83669594016?pwd=MTFOWU1tcG12Uy9yTGN3WlhXSzFqQT09>

Meeting ID: 836 6959 4016

Passcode: 6E4ggb

One tap mobile

+13017158592,,83669594016#,,,,*496831# US (Washington DC)

+13126266799,,83669594016#,,,,*496831# US (Chicago)

Dial by your location

+1 301 715 8592 US (Washington DC)

+1 312 626 6799 US (Chicago)

+1 646 876 9923 US (New York)

+1 253 215 8782 US (Tacoma)

+1 346 248 7799 US (Houston)

+1 408 638 0968 US (San Jose)

+1 669 900 6833 US (San Jose)

Meeting ID: 836 6959 4016

Passcode: 496831

Find your local number: <https://us02web.zoom.us/j/83669594016?pwd=MTFOWU1tcG12Uy9yTGN3WlhXSzFqQT09>

ACKNOWLEDGMENT: Each Proposer shall acknowledge receipt of this Addendum No. 4 by his or her signature below, **and a copy of this Addendum to be returned with proposal.**

CERTIFICATION BY PROPOSER

The undersigned acknowledges receipt of this Addendum No. 4 and the Proposal submitted is in accordance with information, instructions, and stipulations set forth herein.

PROPOSER: _____

BY: _____

DATE: _____

CITY OF _____ FINANCIAL SERVICES
GAINESVILLE PROCEDURES MANUAL

41-423 Prohibition of lobbying in procurement matters

Except as expressly set forth in Resolution 060732, Section 10, during the Blackout period as defined herein no person may lobby, on behalf of a competing party in a particular procurement process, City Officials or employees except the purchasing division, the purchasing designated staff contact. Violation of this provision shall result in disqualification of the party on whose behalf the lobbying occurred.

Blackout period means the period between the issue date which allows for immediate submittals to the City of Gainesville Purchasing Department for an invitation for bid or the request for proposal, or qualifications, or information, or the invitation to negotiate, as applicable, and the time the City Officials and Employee awards the contract.

Lobbying means when any natural person for compensation, seeks to influence the governmental decision making, to encourage the passage, defeat, or modification of any proposal, recommendation or decision by City Officials and Employees, except as authorized by procurement documents.

BID FORM

Clarence R. Kelly Community Center and Park, Located at 1701 NE 8th Ave, Gainesville, FL 32641

TABLE OF CONTENTS

| | Page |
|---|-------------|
| ARTICLE 1 – Bid Recipient | 1 |
| ARTICLE 2 – Bidder’s Acknowledgements | 1 |
| ARTICLE 3 – Bidder’s Representations | 1 |
| ARTICLE 4 – Bidder’s Certification | 2 |
| ARTICLE 5 – Basis of Bid | 3 |
| ARTICLE 6 – Time of Completion | 3 |
| ARTICLE 7 – Attachments to this Bid | 3 |
| ARTICLE 8 – Defined Terms..... | 4 |
| ARTICLE 9 – Bid Submittal | 4 |

ARTICLE 1 – BID RECIPIENT

1.01 This Bid is submitted to:

City of Gainesville
200 East University Avenue, Room 339 – Gainesville, Florida 32601

1.02 The undersigned Bidder proposes and agrees, if this Bid is accepted, to enter into an Agreement with Owner in the form included in the Bidding Documents to perform all Work as specified or indicated in the Bidding Documents for the prices and within the times indicated in this Bid and in accordance with the other terms and conditions of the Bidding Documents.

ARTICLE 2 – BIDDER’S ACKNOWLEDGEMENTS

2.01 Bidder accepts all of the terms and conditions of the Instructions to Bidders, including without limitation those dealing with the disposition of Bid security. This Bid will remain subject to acceptance for 60 days after the Bid opening, or for such longer period of time that Bidder may agree to in writing upon request of Owner.

ARTICLE 3 – BIDDER’S REPRESENTATIONS

3.01 In submitting this Bid, Bidder represents that:

A. Bidder has examined and carefully studied the Bidding Documents, and any data and reference items identified in the Bidding Documents, and hereby acknowledges receipt of the following Addenda:

| <u>Addendum No.</u> | <u>Addendum, Date</u> |
|---------------------|-----------------------|
| _____ | _____ |
| _____ | _____ |
| _____ | _____ |
| _____ | _____ |

B. Bidder has visited the Site, conducted a thorough, alert visual examination of the Site and adjacent areas, and become familiar with and satisfied itself as to the general, local, and Site conditions that may affect cost, progress, and performance of the Work.

C. Bidder is familiar with and has satisfied itself as to all Laws and Regulations that may affect cost, progress, and performance of the Work.

D. Bidder has carefully studied all: (1) reports of explorations and tests of subsurface conditions at or adjacent to the Site and all drawings of physical conditions relating to existing surface or subsurface structures at the Site that have been identified in the Instructions to Bidders, especially with respect to Technical Data in such reports and drawings

E. Bidder has considered the information known to Bidder itself; information commonly known to contractors doing business in the locality of the Site; information and observations obtained from visits to the Site; the Bidding Documents; and any Site-related reports and drawings identified in the Bidding Documents, with respect to the effect of such information, observations, and documents on (1) the cost, progress, and performance of the Work; (2)

the means, methods, techniques, sequences, and procedures of construction to be employed by Bidder; and (3) Bidder's safety precautions and programs.

- F. Bidder agrees, based on the information and observations referred to in the preceding paragraph, that no further examinations, investigations, explorations, tests, studies, or data are necessary for the determination of this Bid for performance of the Work at the price bid and within the times required, and in accordance with the other terms and conditions of the Bidding Documents.
- G. Bidder is aware of the general nature of work to be performed by Owner and others at the Site that relates to the Work as indicated in the Bidding Documents.
- H. Bidder has given Project Manager written notice of all conflicts, errors, ambiguities, or discrepancies that Bidder has discovered in the Bidding Documents, and confirms that the written resolution thereof by Project Manager acceptable to Bidder.
- I. The Bidding Documents are generally sufficient to indicate and convey understanding of all terms and conditions for the performance and furnishing of the Work.
- J. The submission of this Bid constitutes an incontrovertible representation by Bidder that Bidder has complied with every requirement of this Article, and that without exception the Bid and all prices in the Bid are premised upon performing and furnishing the Work required by the Bidding Documents.

ARTICLE 4 – BIDDER'S CERTIFICATION

4.01 Bidder certifies that:

- A. This Bid is genuine and not made in the interest of or on behalf of any undisclosed individual or entity and is not submitted in conformity with any collusive agreement or rules of any group, association, organization, or corporation;
- B. Bidder has not directly or indirectly induced or solicited any other Bidder to submit a false or sham Bid;
- C. Bidder has not solicited or induced any individual or entity to refrain from bidding; and
- D. Bidder has not engaged in corrupt, fraudulent, collusive, or coercive practices in competing for the Contract. For the purposes of this Paragraph 4.01.D:
 - 1. "corrupt practice" means the offering, giving, receiving, or soliciting of anything of value likely to influence the action of a public official in the bidding process;
 - 2. "fraudulent practice" means an intentional misrepresentation of facts made (a) to influence the bidding process to the detriment of Owner, (b) to establish bid prices at artificial non-competitive levels, or (c) to deprive Owner of the benefits of free and open competition;
 - 3. "collusive practice" means a scheme or arrangement between two or more Bidders, with or without the knowledge of Owner, a purpose of which is to establish bid prices at artificial, non-competitive levels; and
 - 4. "coercive practice" means harming or threatening to harm, directly or indirectly, persons or their property to influence their participation in the bidding process or affect the execution of the Contract.

ARTICLE 5 – BASIS OF BID

5.01 Bidder will complete the Work in accordance with the Contract Documents for the following price(s):

| | |
|--|------------|
| Lump Sum Bid Price for Base Bid* | \$ |
| Allowance for Playground and Adult Fitness Equipment (<i>Equipment purchase only. The City will execute an owner direct purchase of this equipment through a deductive change order after the bid award.</i>) | \$ 225,000 |
| Allowance for Playground and Adult Fitness Equipment Installation | \$60,000 |
| Allowance for Audio-visual equipment. Contractor to purchase equipment and facilitate installation. | \$ 30,000 |
| Allowance for Security Camera Pre-Wire & Installation. Contractor to purchase equipment and facilitate installation. | \$ 20,000 |
| Bid Total: | \$ |

***Please note that the City will apply AND pay for the Site Work, Building Permits and Tree Mitigation fee in advance of the bid award. These specific permits will be transferred to the bidder after the bid award. The bidder shall include all other necessary permit fees in their base bid price.**

Total number of calendar days to substantially complete the Work: 270 days.

Liquidated Damages Rate (from Agreement): \$ 500.00 /day.

Bonds required under Paragraph 6.01 of the General Conditions will be based on the Contract Price.

ARTICLE 6 – TIME OF COMPLETION

6.01 Bidder agrees that the Work will be substantially complete within 270 calendar days after the date when the Contract Times commence to run as provided in Paragraph 4.01 of the General Conditions, and will be completed and ready for final payment in accordance with Paragraph 15.06 of the General Conditions within 300 calendar days after the date when the Contract Times commence to run.

6.02 Bidder accepts the provisions of the Agreement as to liquidated damages.

ARTICLE 7 – ATTACHMENTS TO THIS BID

7.01 The following documents are submitted with and made a condition of this Bid:

- A. Bidder Qualifications Statement
- B. Evidence of authority for individuals listed in Section 6 of the Qualifications Statement to bind organization to an agreement
- C. General Contractor’s License **OR** Building Contractor’s License
- D. Evidence of Bidder’s authority to do business in the state where the Project is located

- E. Letter from Bonding Company; Evidence that Bidder can obtain a Payment and Performance Bond on the project if it is awarded the bid
- F. Drug Free WorkPlace Form
- G. Affidavit of Non-Collusion
- H. Certification of Compliance with Living Wage

ARTICLE 8 – DEFINED TERMS

8.01 The terms used in this Bid with initial capital letters have the meanings stated in the Instructions to Bidders, and the General Conditions.

ARTICLE 9 – BID SUBMITTAL

BIDDER: *[Indicate correct name of bidding entity]*

By:

[Signature] _____

[Printed name] _____

(If Bidder is a corporation, a limited liability company, a partnership, or a joint venture, attach evidence of authority to sign.)

Attest:

[Signature] _____

[Printed name] _____

Title: _____

Submittal Date: _____

Address for giving notices:

Telephone Number: _____

Fax Number: _____

Contact Name and e-mail address: _____

Bidder's License No.: _____

(where applicable)

DRUG FREE WORKPLACE FORM

The undersigned vendor in accordance with Florida Statute 287.087 hereby certifies that

_____ does:
(Name of Business)

1. Publish a statement notifying employees that the unlawful manufacture, distribution, dispensing, possession, or use of a controlled substance is prohibited in the workplace and specifying the actions that will be taken against employees for violations of such prohibition.
2. Inform employees about the dangers of drug abuse in the workplace, the business's policy of maintaining a drug-free workplace, any available drug counseling, rehabilitation, and employee assistance programs, and the penalties that may be imposed upon employees for drug abuse violations.
3. Give each employee engaged in providing the commodities or contractual services that are under bid a copy of the statement specified in subsection (1).
4. In the statement specified in subsection (1), notify the employees that, as a condition of working on the commodities or contractual services that are under bid, the employee will abide by the terms of the statement and will notify the employer of any conviction of, or plea of guilty of nolo contendere to, any violation of Chapter 893, Florida Statutes, or of any controlled substance law of the United State or any state, for a violation occurring in the workplace no later than five (5) days after such conviction.
5. Impose a sanction on, or require the satisfactory participation in a drug abuse assistance or rehabilitation program if such is available in the employee's community, by any employee who is so convicted.
6. Make a good faith effort to continue to maintain a drug-free workplace through implementation of this section.

As the person authorized to sign the statement, I certify that this firm complies fully with the above requirements.

Bidder's Signature

Date

CITY OF GAINESVILLE

AFFIDAVIT OF NON-COLLUSION

I hereby swear (or affirm) under the penalty of perjury:

(1) *That I am the bidder (if the bidder is an individual), a partner of the bidder (if the bidder is a partnership), or an officer or employee of the bidding corporation with authority to sign on its behalf (if the bidder is a corporation);*

(2) *That the attached bid or bids have been arrived at by the bidder independently, and have been submitted without collusion with, and without any agreement, understanding, or planned common course of action with any other vendor of materials, supplies, equipment, or services described in the invitation to bid, designed to limit independent bidding or competition.*

(3) *That the contents of the bid or bids have not been communicated by the bidder or its employees or agents to any person not an employee or agent of the bidder or its surety on any bond furnished with the bid or bids; and*

(4) *That I have fully informed myself regarding the accuracy of the statements made in this affidavit.*

Signed: _____

Firm Name: _____

Subscribed and sworn to before me this _____ day of _____ 20_____

Notary Public

My Commission expires _____, 20_____.

Proposer's E.I. Number: _____

(Number used on Employer's Quarterly Federal tax return)

LIVING WAGE DECISION TREE

While not all encompassing, the following is provided as a guideline for contractors in determining whether the City of Gainesville Living Wage Ordinance applies to their firm in the performance of specified service contracts for covered services* with the City. Contractors are advised to review the entire text of the Living Wage Ordinance in conjunction with this guideline.

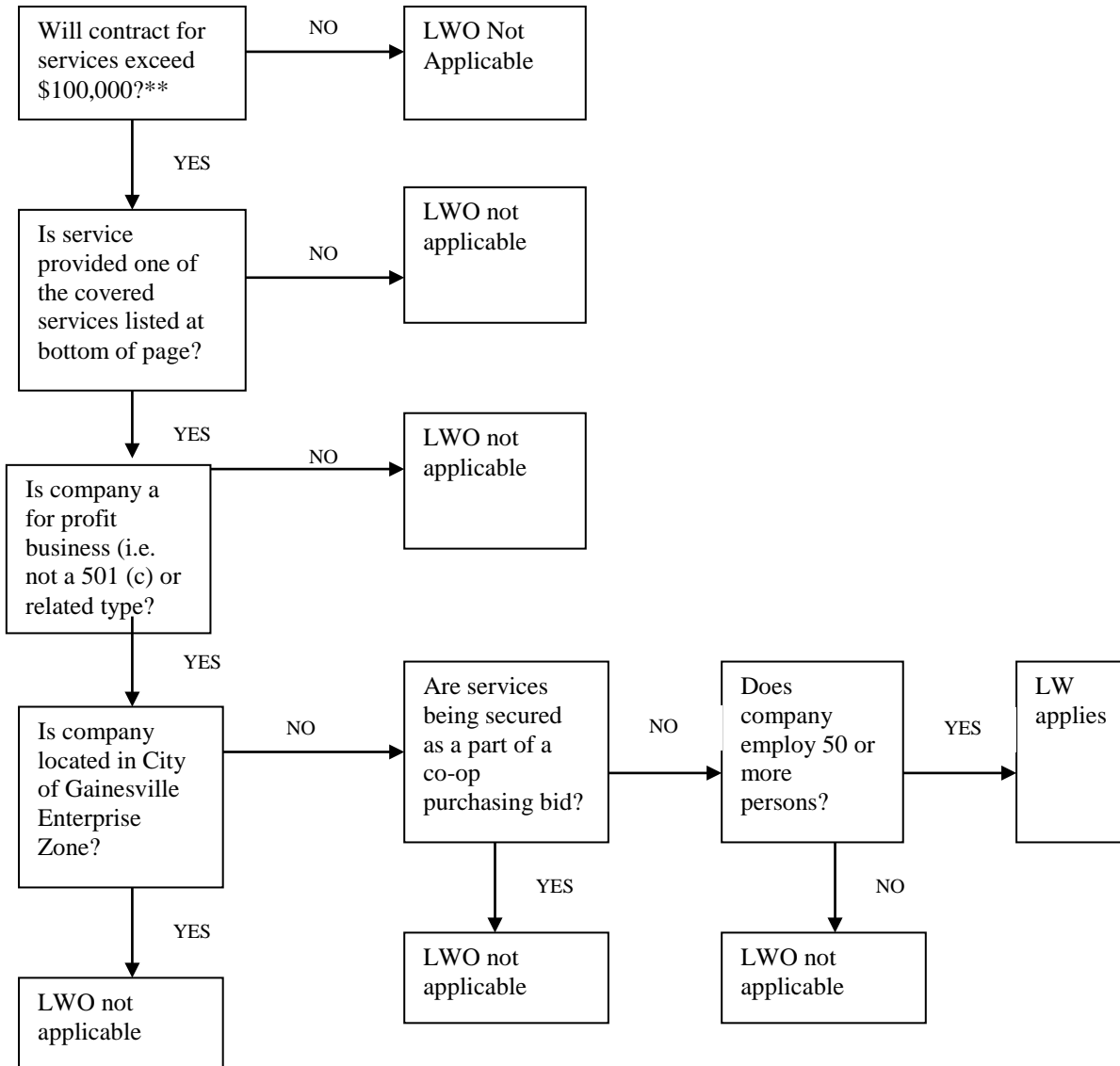

***Covered Services:** food preparation and/or distribution; custodial/cleaning; refuse removal; maintenance and repair; recycling; parking services; painting/refinishing; printing and reproduction services; landscaping/grounds maintenance; agricultural/forestry services; and construction services

****Total value of contract**

CITY OF GAINESVILLE

CERTIFICATION OF COMPLIANCE WITH LIVING WAGE

The undersigned hereby agrees to comply with the terms of the Living Wage Ordinance and to pay all covered employees, as defined by City of Gainesville Ordinance 020663 as amended at 030168 (Living Wage Ordinance), during the time they are directly involved in providing covered services under the contract with the City of Gainesville for **Clarence R. Kelly Community Center and Park** a living wage of \$ **12.3798** per hour to covered employees who receive Health Benefits from the undersigned employer and \$ **13.6298** per hour to covered employees not offered health care benefits by the undersigned employer.

Name of Service Contractor/Subcontractor: _____

Address: _____

Phone Number: _____

Name of Local Contact Person _____

Address: _____

Phone Number: _____

\$ _____

(Amount of Contract)

Signature: _____ Date: _____

Printed Name: _____

Title: _____



GREASE TRAP/INTERCEPTOR PERMIT

APPLICANT (OWNER) NAME City of Gainesville Parks Recreation & Cultural Affairs Department
 FACILITY NAME Clarence R. Kelly Recreation Center PHONE 352-514-8992
 FACILITY ADDRESS 1701 NE 8th Ave
 TYPE (Sit Down/TakeOut/Drive-Through) Sit Down
 MAXIMUM SEATING CAPACITY 80 MAXIMUM HOURS OF OPERATION PER DAY 12
 TYPE OF DEVELOPMENT New Construction

FOOD PREPARATION (check any that apply)

- Deep Frying
- Grilling
- Baking
- Pan Frying
- Heating
- PrePrepared Food

KITCHEN EQUIPMENT

- Dishwasher Dishwasher Flow _____ (gpm)
- Garbage Disposal
- 3-Compartment Sinks: Quantity 1
- Inside Dimensions of 3-Comp. Sink Bowl (inches)
 Depth 7-5/8" Width 22" Length 46"
- Total # of Kitchen Sinks 2 Pipe Diameter 3"
- Total # of Floor Drains 2 Pipe Diameter 3"

PRETREATMENT (check if present & provide size)

Existing Grease Trap _____
 Rating or Size _____

I hereby certify that the above information is correct. I am aware that changes in any of the above information will require a re-application and possible increase in the size or type of grease trap/interceptor required. I agree to have the grease trap/interceptor cleaned/pumped out at the minimum frequently as determined below or more frequently if needed, to maintain the grease interceptor in proper operating condition.
 I agree to submit proof to GRU within 7 days of each pump out of the trap/interceptor by a certified grease hauler. If the trap/interceptor is maintained by facility personnel, I agree to submit to GRU semi-annually a copy of all mainenance performed within the previous six months.
 This permit is valid only for the specific facility, ownership, processes and operations indicated above. As such, it cannot be sold, transferred, or reassigned.

Applicant Signature *Peter McNiece* Date 05-22-2020
 Applicant Email McNiecePR@CityofGainesville.org

PERMIT REQUIREMENTS (To be completed by GRU Water/Wastewater Engineering)

TYPE of TRAP/INTERCEPTOR: INGROUND SIZE: 1,050 gal
 PUMPOUT/CLEAN-OUT FREQUENCY: 60 days

OTHER REQUIREMENTS:
Requirements of this permit including pumping frequency and grease trap/interceptor size are subject to change with change in operations or collection system problems.

GRU Rep: *M. Larsen* DATE: 6/12/2020

Oil & Grease Management Program, PO Box 147117, Station E3-F, Gainesville, FL 32617-7117
 Fax: 352-334-2752, Phone: 352-393-1698

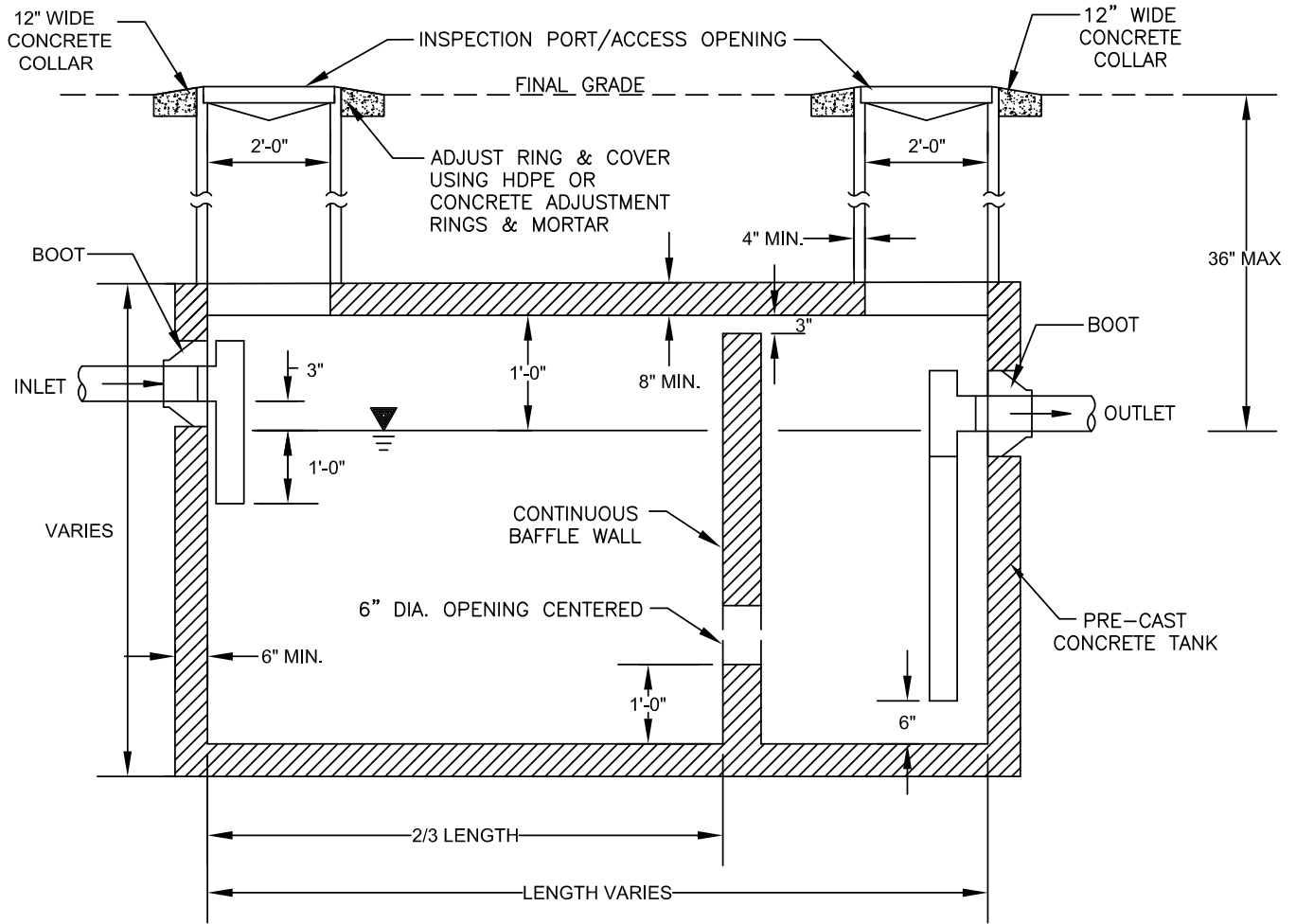

NOTES:

1. TANK VOLUME TO BE DETERMINED BY GRU UPON APPLICATION BY OWNER, STRUCTURAL DESIGN SHALL BE THE RESPONSIBILITY OF THE TANK MANUFACTURER.
2. ONLY KITCHEN WASTE SHALL BE DISCHARGED INTO THE GREASE TRAP. ALL DOMESTIC WASTE (i.e. RESTROOMS) SHALL BE CONNECTED DOWNSTREAM OF THE GREASE TRAP.
3. MANHOLES WHICH ARE NOT INSTALLED UNDER PAVEMENT SHALL HAVE A RIM ELEVATION AT LEAST 6" ABOVE FINISHED GRADE, AND A 10:1 SLOPE TO FINISHED GRADE.
4. GREASE TRAP ASSEMBLY TO BE H-20 TRAFFIC LOAD RATED - INCLUDING TANK, TANK LID, CHIMNEYS AND MANHOLE RING & COVER.
5. NO CAPPED TEES.

Revision Date:
01/09/19



Gainesville Regional Utilities
Wastewater Construction Details

GREASE TRAP

In reference to question #45



June 16, 2020

Dear Natalia,

Re: Schier Interceptor Selection for Clarence R. Kelly Community Center

Based on the sizing information provided for the referenced community center located at 1701 NE 8th Ave. Schier Products agrees and endorses the grease production sizing and GB-50 grease interceptor selection for the kitchen. If the GB-50 is installed per Schier guidelines and is being maintained properly, Schier will guarantee that it will protect the collection system. If you are not satisfied, Schier will work with both the owner and pretreatment personnel, at our expense, until the situation is remedied.

The Schier system is first sized by flow rate to satisfy the current Florida building code; 2017 6th edition. Grease production is then factored using an approved 60 day pump out cycle and the kitchen is classified as low grease output. Sized using 200 meals per day. There is no frying, grilling, or baking in the kitchen only heating prepared meals.

Thank you,

David Hollingsworth

Schier Products – Central FL

407-716-9296

GREASE INTERCEPTOR CALCULATIONS

Reviewed by: Tye

Reference No. 19067

Project Name: Clarence Kelly Rec Center

Step 1: Flow rate to grease interceptor

Fixture flow rate: $(cu\ in / 231) = gal \times 0.75 / 2\ min = 2\ min\ flow\ rate$

| NAME | TYPE | DIMENSIONS | QTY | CU IN | FLOW RATE |
|----------------------------|--------------------|--------------------|-----|-------|-----------|
| 3 COMP | 3 Compartment Sink | 14" x 16" x 8" (3) | 1 | 5,376 | 8.73 GPM |
| FLOOR DRAIN | Floor Sink | N/A | 2 | N/A | 4 GPM |
| FLR SINK / 3 COMP INDIRECT | Floor Sink | N/A | 1 | N/A | N/A |
| HAND | Hand Sink | 12" x 9" x 6" | 1 | 648 | 1.05 GPM |
| KIT SINK | Prep Sink One Bowl | 21" x 16" x 10" | 1 | 3,360 | 5.45 GPM |
| MOP | Mop Basin | 24" x 24" x 10" | 1 | 5,760 | 9.35 GPM |

Total **28.58 GPM**

Step 2: Grease Production

$Servings\ per\ day \times Grease\ production\ value \times Days\ between\ pump-outs = Grease\ output$

Number of meals served per day: 200

Grease production value: 0.005 lbs per serving (Sandwich Shop: Low / No flatware)

Days between pump-outs: 60 days

$200 \times 0.005 \times 60 = 60\ lbs\ of\ FOG$

| SCHIER MODEL | Description: Polyethylene Grease Interceptor |
|--------------|--|
| GB-50 | Dimensions: Length: 37", Width: 28", Height: 28.5" Flow Rates/Grease Capacities: 50 GPM / 249.0 lbs Liquid Capacity: 52 gal |