

LEGISLATIVE #

200724A

ORDINANCE NO. 200724

1
2
3 **An ordinance of the City of Gainesville, Florida, amending the Zoning Map**
4 **Atlas by rezoning approximately 42.973 acres of property known as Oak Hall**
5 **School generally located at 1700 SW 75th Street, as more specifically described**
6 **in this ordinance, from Alachua County Planned Development (PD) to City of**
7 **Gainesville Education (E); providing directions to the City Manager; providing a**
8 **severability clause; providing a repealing clause; and providing an effective**
9 **date.**

10
11
12 **WHEREAS**, Section 163.3167, Florida Statutes, requires the City of Gainesville to maintain a
13 Comprehensive Plan to guide the future development and growth of the city; and

14 **WHEREAS**, Section 163.3177(6), Florida Statutes, requires the City of Gainesville
15 Comprehensive Plan to include a Future Land Use Element with a Future Land Use Map that
16 designates the future general distribution, location, and extent of the uses of land for
17 residential, commercial, industry, agriculture, recreation, conservation, education, public
18 facilities, and other categories of the public and private uses of land, with the goals of
19 protecting natural and historic resources, providing for the compatibility of adjacent land uses,
20 and discouraging the proliferation of urban sprawl; and

21 **WHEREAS**, the City of Gainesville is required by Section 163.3202, Florida Statutes, to adopt or
22 amend and enforce land development regulations that are consistent with and implement the
23 Comprehensive Plan and that are combined and compiled into a single land development code
24 for the city; and

25 **WHEREAS**, the City of Gainesville Land Development Code (Chapter 30 of the City of Gainesville
26 Code of Ordinances) establishes zoning districts to implement the Comprehensive Plan and
27 land development regulations on specific classifications of land within the city; and

28 **WHEREAS**, this ordinance, which was noticed as required by law, will amend the Zoning Map
29 Atlas by rezoning the property that is the subject of this ordinance; and

30 **WHEREAS**, the City Plan Board, which acts pursuant to the authority granted in Section 4.02 of
31 the Charter Laws of the City of Gainesville and which acts as the Local Planning Agency
32 pursuant to Section 163.3174, Florida Statutes, held a public hearing on January 28, 2021, and
33 voted to provide a recommendation to the City Commission; and

34 **WHEREAS**, an advertisement no less than two columns wide by ten inches long was placed in a
35 newspaper of general circulation and provided the public with at least seven days' advance
36 notice of this ordinance's first public hearing to be held by the City Commission; and

37 **WHEREAS**, a second advertisement no less than two columns wide by ten inches long was
38 placed in the aforesaid newspaper and provided the public with at least five days' advance
39 notice of this ordinance's second public hearing to be held by the City Commission; and

40 **WHEREAS**, public hearings were held pursuant to the notice described above at which hearings
41 the parties in interest and all others had an opportunity to be and were, in fact, heard; and

42 **WHEREAS**, the City Commission finds that the rezoning of the subject property will be
43 consistent with the City of Gainesville Comprehensive Plan when the amendment to the
44 Comprehensive Plan adopted by Ordinance No. 200723 becomes effective as provided therein.

45 **NOW, THEREFORE, BE IT ORDAINED BY THE CITY COMMISSION OF THE CITY OF GAINESVILLE,**

46 **FLORIDA:**

47 **SECTION 1.** The Zoning Map Atlas of the City of Gainesville is amended by rezoning the
48 following property from Alachua County Planned Development (PD) to City of Gainesville
49 Education (E):

50 See legal description attached as **Exhibit A** and made a part hereof as if set forth
51 in full. The location of the property is shown on **Exhibit B** for visual reference.
52 In the event of conflict or inconsistency, **Exhibit A** shall prevail over **Exhibit B**.

53
54 **SECTION 2.** The City Manager or designee is authorized and directed to make the necessary
55 changes to the Zoning Map Atlas to comply with this ordinance.

56 **SECTION 3.** If any word, phrase, clause, paragraph, section, or provision of this ordinance or
57 the application hereof to any person or circumstance is held invalid or unconstitutional, such
58 finding will not affect the other provisions or applications of this ordinance that can be given
59 effect without the invalid or unconstitutional provision or application, and to this end the
60 provisions of this ordinance are declared severable.

61 **SECTION 4.** All ordinances or parts of ordinances in conflict herewith are to the extent of such
62 conflict hereby repealed.

63 **SECTION 5.** This ordinance will become effective immediately upon adoption; however, the
64 rezoning will not become effective until the amendment to the City of Gainesville
65 Comprehensive Plan adopted by Ordinance No. 200723 becomes effective as provided therein.

66
67 **PASSED AND ADOPTED** this ____ day of _____, 2021.

68
69
70
71
72
73
74
75
76
77
78
79

LAUREN POE
MAYOR

Attest:

Approved as to form and legality:

OMICHELE D. GAINEY
CITY CLERK

NICOLLE M. SHALLEY
CITY ATTORNEY

80

81

82 This ordinance passed on first reading this ____ day of _____, 2021.

83

84 This ordinance passed on second reading this ____ day of _____, 2021.

**OAK HALL PROPERTY; TAX PARCELS 6668-2-3 & 6668-2-5
DESCRIPTION FOR PROPOSED ANNEXATION IN SECTION 8, TOWNSHIP 10
SOUTH, RANGE 19 EAST, ALACHUA COUNTY, FLORIDA**

A PARCEL OF LAND LYING AND BEING IN SECTION 8, TOWNSHIP 10 SOUTH, RANGE 19 EAST, ALACHUA COUNTY, FLORIDA, BEING MORE PARTICULARLY DESCRIBED AS FOLLOWS:

COMMENCE AT THE SOUTHWEST CORNER OF PARCEL # 3 OF MINOR SUBDIVISION BOOK 34, PAGE 62 FILED AS AN UNRECORDED MAP IN THE PUBLIC RECORDS OF ALACHUA COUNTY, FLORIDA (HEREAFTER REFERRED TO AS PRACF) ALSO BEING A POINT ON THE EXISTING CITY OF GAINESVILLE LIMIT LINE PER CITY ORDINANCE NUMBER 150912 AND AT THE POINT OF INTERSECTION OF THE EAST RIGHT-OF-WAY LINE OF S.W. 75TH STREET (ALSO KNOWN AS TOWER ROAD) AND THE SOUTH LINE OF LOT NUMBER 4 IN SECTION 9, TOWNSHIP 10 SOUTH, RANGE 19 EAST SAID ALACHUA COUNTY, FLORIDA; THENCE N 00°51'18" W ALONG SAID CITY LIMIT LINE, THE WEST LINE OF SAID PARCEL # 3 AND THE EAST RIGHT-OF-WAY LINE OF S.W. 75TH STREET A DISTANCE OF 263.34 FEET TO A POINT OF INTERSECTION ON THE WEST LINE OF SAID LOT 3; THENCE LEAVING SAID WEST LINE OF LOT # 3 CONTINUE ALONG SAID CITY LIMIT LINE N 00°51'18" W A DISTANCE OF 132.03 FEET TO A POINT ON THE EASTERLY EXTENSION OF THE NORTH LINE OF "SUNRISE", PER THE PLAT THEREOF RECORDED IN PLAT BOOK "I", PAGE 23 PRACF; THENCE LEAVING SAID EXISTING CITY OF GAINESVILLE LIMIT LINE, S 88°53'38" W ALONG SAID EXTENSION A DISTANCE OF 103.04 FEET TO THE SOUTHEAST CORNER OF THAT CERTAIN PARCEL OF LAND AS DESCRIBED IN OFFICIAL RECORDS BOOK 4542, PAGE 244 (HEREAFTER ABBREVIATED ORB __, P__) PRACF ALSO BEING A POINT ON THE NORTH LINE OF SAID PLAT OF "SUNRISE"; THENCE CONTINUE S 88°53'38" W ALONG THE SOUTH LINE OF SAID PARCEL ALSO BEING THE SOUTH LINE OF THAT CERTAIN PARCEL OF LAND AS DESCRIBED IN ORB 1612, P 2865 PRACF A DISTANCE OF 1.81 FEET TO THE POINT OF BEGINNING OF THE HEREIN DESCRIBED PARCEL; THENCE CONTINUE S 88°53'38" W ALONG THE SOUTH LINE OF SAID PARCEL AND NORTH LINE OF SAID PLAT A DISTANCE OF 1244.14 FEET TO THE NORTHWEST CORNER OF SAID PLAT ALSO BEING THE NORTHEAST CORNER OF "AVALON PHASE 2, UNIT III" PER THE PLAT THEREOF AS RECORDED IN PLAT BOOK "T", PAGE 6 PRACF; THENCE CONTINUE S 88°53'38" W ALONG THE NORTH LINE OF SAID PLAT, SOUTH LINE OF SAID PARCEL AND THE SOUTH LINE OF THAT CERTAIN PARCEL OF LAND AS DESCRIBED IN ORB 720 P 383 (INCLUDING "LESS PORTION") A DISTANCE OF 1252.29 FEET TO THE NORTHWEST CORNER OF SAID PLAT ALSO BEING THE NORTHEAST CORNER OF "AVALON PHASE 2, UNIT II" PER THE PLAT THEREOF AS RECORDED IN PLAT BOOK "R", PAGE 54 PRACF; THENCE CONTINUE S 88°53'38" W ALONG THE NORTH LINE OF SAID PLAT, AND SOUTH LINE OF

SAID PARCEL A DISTANCE OF 94.40 FEET TO THE SOUTHWEST CORNER OF SAID PARCEL ALSO BEING THE SOUTHEAST CORNER OF "COBBLEFIELD UNIT II" PER THE PLAT THEREOF AS RECORDED IN PLAT BOOK "23", PAGES 68 & 69 PRACF; THENCE N00°54'53" W ALONG THE EAST LINE OF SAID "COBBLEFIELD UNIT II" A DISTANCE OF 734.21 FEET TO THE NORTHWEST CORNER OF SAID LANDS DESCRIBED IN ORB 720, P 383 PRACF ALSO BEING THE SOUTHWEST CORNER OF "WESTWOOD" PER THE PLAT THEREOF AS RECORDED IN PLAT BOOK "I", PAGE 66 PRACF; THENCE LEAVING SAID EAST LINE OF "COBBLEFIELD UNIT II", N 89°14'19" E ALONG THE NORTH LINE OF LANDS DESCRIBED IN SAID ORB 720, P 382 PRACF ALSO BEING THE SOUTH LINE OF SAID PLAT A DISTANCE OF 1577.07 FEET TO THE NORTHEAST CORNER OF SAID LANDS DESCRIBED IN ORB 720, P 382 PRACF ALSO BEING THE NORTHWEST CORNER OF THAT CERTAIN PARCEL OF LAND AS DESCRIBED IN ORB 4225, P 417 PRACF; THENCE CONTINUE N 89°14'19" E ALONG THE SOUTH LINE OF SAID "WESTWOOD" AND NORTH LINE OF SAID LANDS DESCRIBED IN ORB 4525, P 417 PRACF A DISTANCE OF 1016.31 FEET TO THE NORTHEAST CORNER OF SAID LANDS ALSO BEING A POINT ON THE WEST RIGHT-OF-WAY LINE OF SAID S.W. 75TH STREET; THENCE S 00°51'18" E ALONG THE EAST LINE OF SAID LANDS AND WEST RIGHT-OF-WAY LINE OF SAID SW 75TH STREET A DISTANCE OF 428.61 FEET TO THE SOUTHEAST CORNER OF SAID LANDS ALSO BEING THE NORTHEAST CORNER OF LANDS DESCRIBED IN THE AFOREMENTIONED ORB 1612, P 2865 PRACF; THENCE CONTINUE ALONG THE EAST LINE OF SAID PARCEL ALSO BEING THE WEST RIGHT-OF-WAY LINE OF SAID SW 75TH STREET THE FOLLOWING 9 COURSES: 1.) S 00°51'18"E, 39.16 FEET; 2.) S 03°44'21" W, 17.04 FEET TO THE BEGINNING OF A CURVE CONCAVE TO THE NORTHWEST HAVING A RADIUS OF 200 FEET; 3.) ALONG THE ARC OF SAID CURVE 129.44 FEET THROUGH A CENTRAL ANGLE OF 37°04'59" BEING SUBTENDEED BY A CHORD OF S 22°16'50" W, 127.20 FEET TO A POINT OF COMPOUND CURVATURE OF A CURVE CONCAVE TO THE NORTHWEST HAVING A RADIUS OF 50.00 FEET; 4.) ALONG THE ARC OF SAID CURVE 20.94 FEET THROUGH A CENTRAL ANGLE OF 23°59'52" BEING SUBTENDEED BY A CHORD OF S 64°49'16" W, 20.79 FEET; 5.) S 64°49'12", 14.91 FEET TO THE BEGINNING OF A CURVE CONCAVE TO THE NORTHWEST HAVING A RADIUS OF 73.00 FEET; 6.) ALONG THE ARC OF SAID CURVE 27.27 FEET THROUGH A CENTRAL ANGLE OF 21°24'04" BEING SUBTENDEED BY A CHORD OF S 75°31'14" W, 27.11; 7.) S 01°01'34", 65.09 FEET; 8.) S 87°38'07" E, 64.58 FEET TO THE BEGINNING OF A CURVE CONCAVE TO THE SOUTHWEST HAVING A RADIUS OF 59.00 FEET; 9.) ALONG THE ARC OF SAID CURVE 49.05 FEET THROUGH A CENTRAL ANGLE OF 47°38'04" BEING SUBTENDEED BY A CHORD OF S 61°32'04" W, 47.65 FEET TO THE POINT OF BEGINNING OF THE HEREIN DESCRIBED PARCEL. CONTAINING 1,871,926 SQUARE FEET OR 42.973 ACRES, MORE OR LESS.

OAK HALL PROPERTY; TAX PARCELS # 6668-2-3 & 6668-2-5

SKETCH & DESCRIPTION FOR PROPOSED ANNEXATION IN SECTION 8, TOWNSHIP 10 SOUTH, RANGE 19 EAST, ALACHUA COUNTY, FLORIDA

SURVEYOR'S NOTES:

1. THE BEARING BASIS FOR THIS SKETCH & DESCRIPTION IS THE WEST LINE OF MINOR SUB BOOK 34, PAGE 62 WITH A VALUE OF N 00°51'18"W. IT IS IDENTICAL TO THE EAST R/W LINE FOUND IN ORB 4542, P 244 FOR ADDITIONAL R/W GRANTED BY OAK HALL FOR SW 75TH STREET,
2. INFORMATION FROM THE PROPERTY APPRAISER'S WEB SITE, DEEDS AND PLATS OF RECORD, THE ALACHUA COUNTY CONTROL DENSIFICATION & IDENTIFICATION OF LAND CORNERS PROJECT AND A JOHN MEYERS SURVEY OF SECTION 9, TOWNSHIP 10 SOUTH, RANGE 19 EAST PROVIDED TO THIS SURVEYOR WERE ALSO USED TO BEST REPRESENT THE LANDS INTENDED TO BE INCLUDED IN THIS SKETCH AND DESCRIPTION.
3. THE ADJACENT SUBDIVISION PLATS DEPICTION IS ADJUSTED TO FIT THE SUBJECT PROPERTY PERIMETER BOUNDARY DEEDS AND MAY NOT BE TO SCALE.

LINE AND ABBREVIATIONS LEGEND:

- | | | |
|--|--|--|
| | = PERIMETER OF DESCRIBED PROPERTY | PB & PG = PLAT BOOK & PAGE |
| | = EXISTING RIGHT OF WAY LINES | ORB & P = OFFICIAL RECORDS BOOK & PAGE |
| | = SECTION LINE | TP # = CURRENT TAX PARCEL NUMBER |
| | = LOT, STREET AND SUBDIVISION LINES | R/W = RIGHT-OF-WAY |
| | = EXISTING EASEMENT LINES | RLS = REGISTERED LAND SURVEYOR |
| | = EAST LINE ORB 4542 P 244 (OLD R/W LINE) | PRACF = PUBLIC RECORDS ALACHUA COUNTY, FLORIDA |
| | = HATCHED AREA REPRESENTS LIMITS OF DESCRIBED PROPERTY | L = LENGTH OF ARC |
| | | R = RADIUS |
| | | PUE = PUBLIC UTILITY EASEMENT |

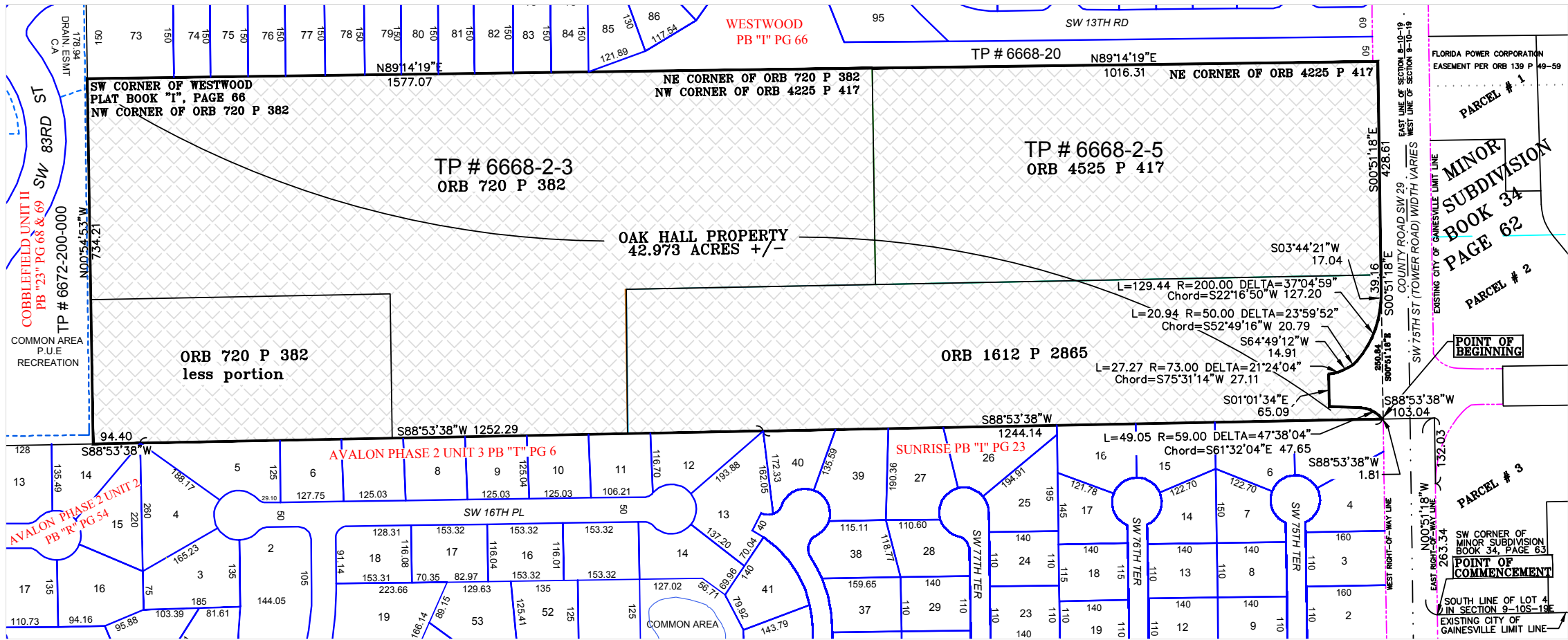
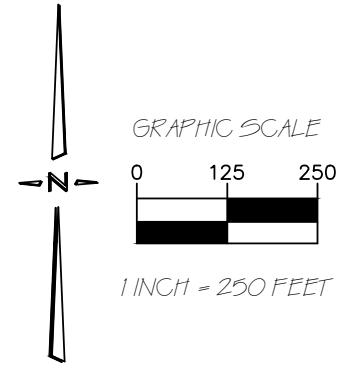

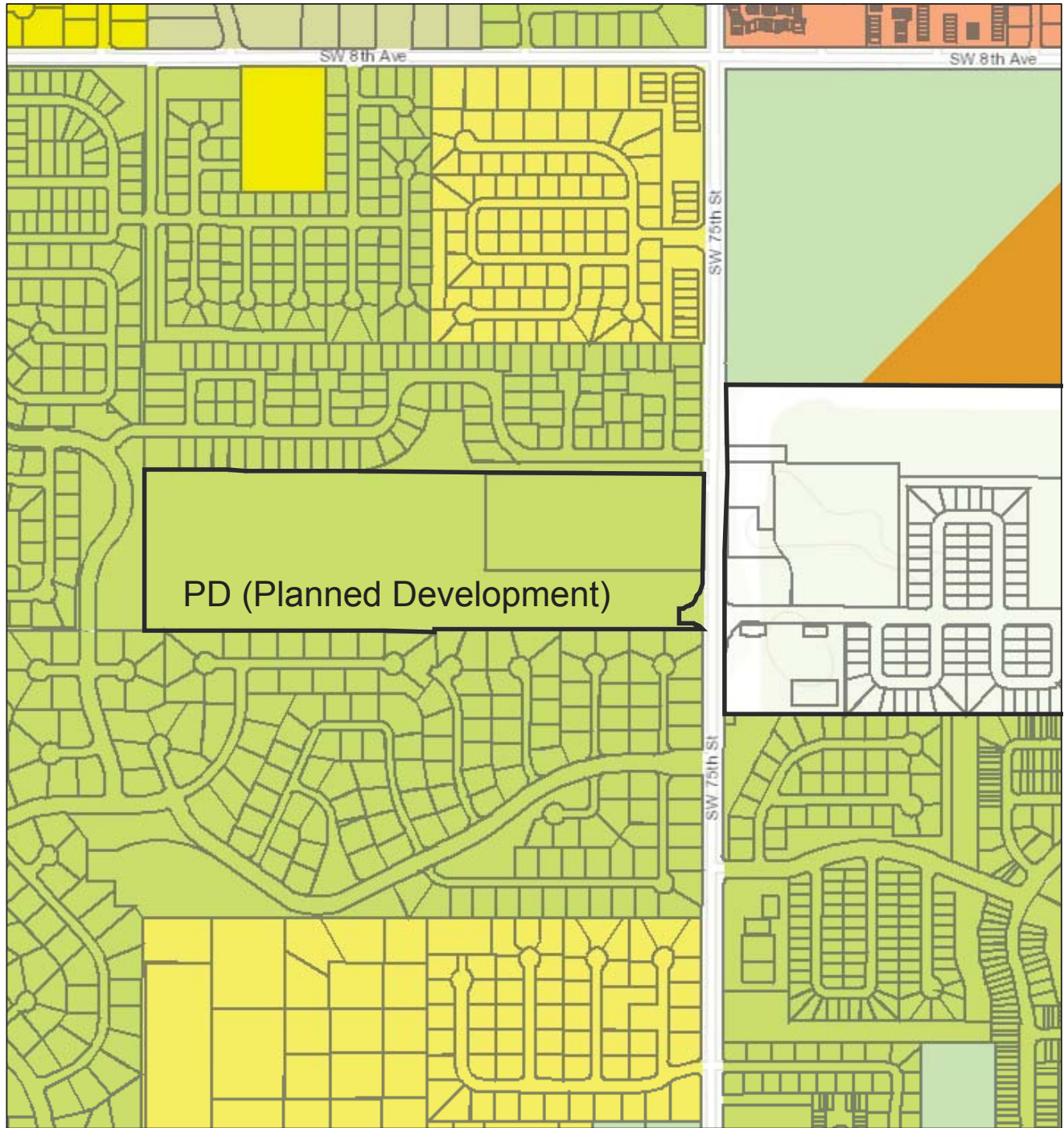

THIS IS NOT A BOUNDARY SURVEY
 SHEET THREE OF THREE: NOT COMPLETE WITHOUT ALL SHEETS
 CITY OF GAINESVILLE PUBLIC WORKS DEPARTMENT
 ENGINEERING SUPPORT SERVICES
 405 NW 39th AVENUE P.O. BOX 490 GAINESVILLE, FL 32627
 OFFICE (352) 393-8194
 DRAWN BY: PRD
 CHECKED BY: IGH
 DATE: 12/12/2019
 CAD FILE NAME:
 OAKHALL-ANNEX
 PATRICK R. DUREIN, RLS FL CERT # 5368
 I HEREBY CERTIFY THAT THIS SKETCH & DESCRIPTION MEETS OR EXCEEDS THE STANDARDS OF PRACTICE AS SET FORTH BY THE BOARD OF PROFESSIONAL LAND SURVEYORS IN CHAPTER 5017 OF THE FLORIDA ADMINISTRATIVE CODE, PURSUANT TO SECTION 4720.07, FLORIDA STATUTES.

Oak Hall School Existing Zoning



3/13/2020 1:41:42 PM

1:9,028

-  Gainesville City Limits
-  Public Parcel

Alachua County Zoning

-  (A) Agricultural
-  (BP) Business/Professional
-  (PD) Planned Development
-  (R-1A) Single Family Residential
-  (R-1AA) Single Family Residential
-  (R-3) Multi-family Residential
-  (RE-1) Residential-Estate

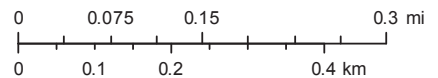

Sources: Esri, HERE, Garmin, Intermap, increment P Corp., GEBCO, USGS, FAO, NPS, NRCAN, GeoBase, IGN, Kadaster NL, Ordnance Survey, Esri Japan, METI, Esri China (Hong Kong), (c) OpenStreetMap contributors, and the GIS User Community

Oak Hall School Proposed Zoning

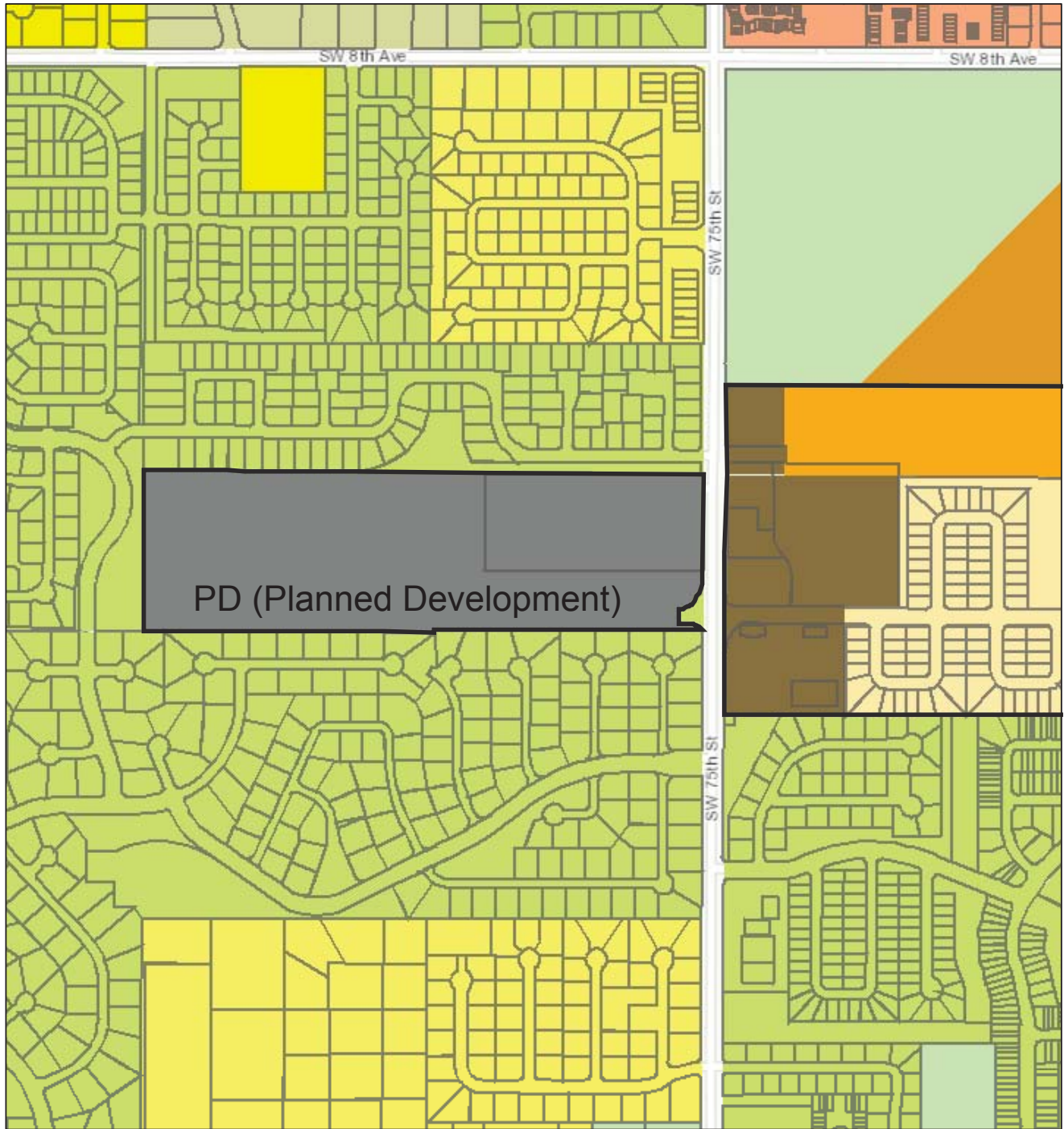

3/13/2020 1:38:28 PM

1:9,028

Gainesville City Limits

Public Parcel

City of Gainesville Zoning

Pending City Zoning

MU-2: Mixed Use Medium Intensity

RMF-5: Single-Family/Multiple-Family Residential

RMF-7: Multiple-Family Residential

Alachua County Zoning

(A) Agricultural

(BP) Business/Professional

(PD) Planned Development

(R-1A) Single Family Residential

(R-1AA) Single Family Residential

(R-3) Multi-family Residential

(RE-1) Residential-Estate

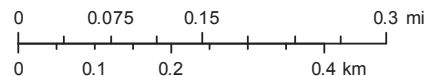

Sources: Esri, HERE, Garmin, Intermap, increment P Corp., GEBCO, USGS, FAO, NPS, NRCAN, GeoBase, IGN, Kadaster NL, Ordnance Survey, Esri Japan, METI, Esri China (Hong Kong), (c) OpenStreetMap contributors, and the GIS User Community

Department of Sustainable Development

County of Alachua, Esri, HERE, Garmin, INCREMENT P, Intermap, USGS, METI/NASA, EPA, USDA | (1) KBN Engineering and Applied Sciences, ed.

(2) Alachua County Department of Growth Management, comp.

the Alachua County Environmental Protection Department (352) 264-6800 | U.S. Fish and Wildlife Service, National Standards and Support Team, wetlands_team@fws.gov | Department of Planning - City of Gainesville |